



BCH

**BCH
ELECTRIC
LIMITED**

**LOW VOLTAGE
SWITCHGEAR PRODUCTS**

Price List effective 17th November 2025

Modern facilities at Faridabad & Rudrapur



Our Strengths

- ◆ State-of-the-art product development and R&D
- ◆ Modern manufacturing facilities
- ◆ Tool room with latest facilities
- ◆ Serving customers for five decades
- ◆ Presence in ~50 locations
- ◆ 650 channel partners
- ◆ ISO 9001:2015 & ISO 14001:2015, ISO 45001: 2018 certified company

Core Values

- ◆ Integrity
- ◆ Nurturing People
- ◆ Commitment to Customers
- ◆ Striving for Excellence
- ◆ Long Term Thinking

Quality Policy

We as a member of BCH Electric Limited manufacturer of Low Voltage Switchgear & Controlgear products, are fully committed to provide Quality products and service in compliance with applicable Statutory and Regulatory requirements, to meet or exceed the customer need and expectations through -

- ◆ Continual improvement
- ◆ Involvement of employees
- ◆ Setting Quality objectives
- ◆ Training and development of employees

Health & Safety Policy

We as a member of BCH Electric Limited manufacturer of Low Voltage Switchgear & Controlgear products, are fully committed to conduct Business in compliance to applicable Health & Safety legislation and regulation.

We shall continually improve through -

- ◆ Provide Safe & Healthy working conditions for the prevention of work related injury and ill health.
- ◆ Develop & maintain the Health & Safety objectives & targets and conduct health & safety programs for achieving the objectives and target.
- ◆ The prevention of accidents through the identification, assessment and elimination of workplace hazards and the promotion of health & safety awareness among its employees and contractors.
- ◆ Encourage employee's participation and consultation in matters affecting the health, safety and well being of our people and seek suggestions from our employees of ways in which health, safety & well being can be furthered.

The Health & safety policy is publicly available on request.

Environmental Policy

We as a member of BCH Electric Limited manufacturer of Low Voltage Switchgear & Controlgear products, are fully committed to conduct Business in compliance to applicable Environmental legislation and regulation.

We shall continually improve through -

- ◆ Provide a framework for setting and reviewing environmental objectives and targets.
- ◆ Regularly review the impact of our activities on environment and strive to reduce the pollution/waste.
- ◆ Involve employees in our environmental program and provide necessary training to enable them to discharge their responsibilities towards environment management.
- ◆ Sustain the program of continual improvement in environment in environmental performance incorporating suitable metrics and monitoring.

The Environment policy is publicly available on request.

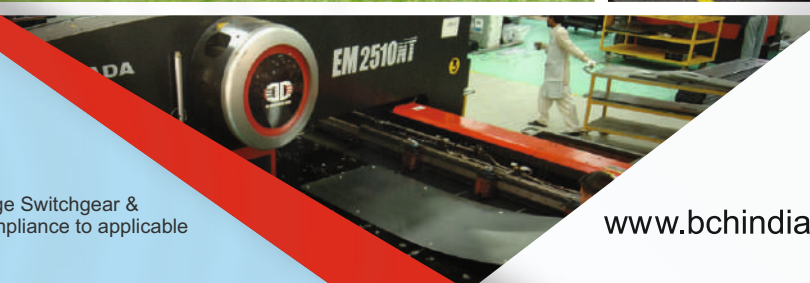
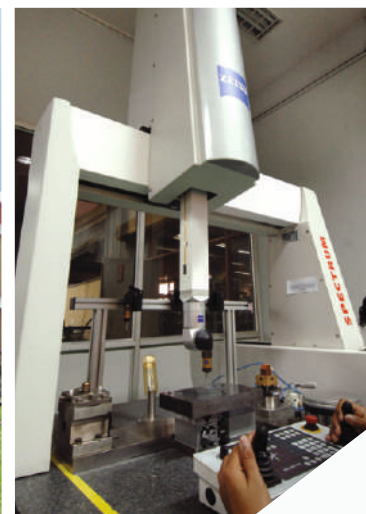

www.bchindia.com

Our Products



Power Distribution



Final Distribution Products



Industrial Control & Protection



Industrial Brakes



Industrial Automation & Safety



Starters



Enclosures



Wires & Cables



Power Quality & Energy Management



Electric Motors



Switchboards & Solutions

INDEX

Power Distribution

• Air Circuit Breakers.....	2
• MCCBs - X Range.....	9
• X-Line SDF, FSU, SDFU.....	17
• Polycarbonate Plug & Socket BPX Series.....	20
• Plugs & Sockets.....	23
• Plug & Socket Boxes.....	25

* Terasaki ACB's products are also available on request.

Final Distribution Products

• MCB.....	27
• Isolators, MCB Distribution Boxes.....	28
• RCCB.....	30

Industrial Control & Protection

• AC Contactors, Accessories & Spares.....	33
• Mini Contactor, OLR & Accessories.....	41
• Overload Relays - Citation & Freedom.....	49
• Electronic Overcurrent Relays (BOCR).....	52
• Motor Protection Circuit Breakers (MPCB).....	54
• Soft Starters.....	55
• Solid State Relays.....	56
• DC Contactors.....	59
• DC Magnetic Overload Relays.....	61
• Push Buttons, Indicating Lights, LEDs.....	62
• Punched Grid Resistors.....	68

Industrial Brakes

• AC Solenoid & Brakes.....	70
• DC Brakes.....	71

Industrial Automation & Safety

• Limit Switches.....	78
• Foot Switches.....	82
• Pneumatic Timers.....	83
• Electronic Timers.....	84
• AC Drives.....	86
• Digital DC Drives.....	87
• e-prox Proximity Sensors.....	88
• Plug-in Relays.....	92

Starters

• Motor Starters.....	95
- Shakti - DOL (Shakti WP & Shakti) & Auto DOL Starters.....	102
- Shakti - Semi & Fully Automatic Star Delta Starters.....	103
- Citation DOL, Citation P - DOL & Auto DOL.....	104
- Citation - SASD, FASD, Highter HP FASD Starters.....	105
- BKI DOL & SASD Starters & Spares.....	106
- FASD with EOOCR, Industrial DOL & Reversing DOL.....	107
- Mini Manual DOL 1Ph & 3Ph, DOL-1Ph & Manual SD Starter.....	108



BCH

• Submersible Pump Starters	109
- 3 -Ph SPS - Citation - DOL & SD and Shakti – DOL	110
- 3-Ph SPS - Citation P - DOL & SD (Standard & Premium)	111
- 3-Ph SPS - Citation P - SD (Range Extension)	112
- 3-Ph SPS - Shakti P - DOL, 1-Ph DOL Starter & SPP Pro	113
- 1-Ph SPS (with CPG Contactor).....	114
- 1-Ph SPS - Alfa Model & Dry Run Protection Panel	115
- Ph SPS - CPD Model & Mini Manual.....	116
- Oil Immersed DOL & Star Delta Starters (SASD & FASD).....	117
- Spare Contactor for Motor starter & SPS	117
- Spares Contact Kit, Coils, Carrier for Motor Starter	118
- Spares for P series SPS, 1-Ph Dry Run SPS, Dual Meter & FR OLR.....	119
- Coil Band Master Table.....	119
	120

Enclosures

• Bhartia Enclosures 2.O.....	122
• Terminal Box 2.O.....	123
• 'BCH-SS' Stainless Steel.....	124
• Terminal Box IP:55 & IP:66	124
• Bhartia Box IP: 55, IP: 66	125
• TCE Series Enclosures.....	126
• Techno- Modular Enclosures.....	131
• MCC, PCC & PMCC Bare Enclosures (Fixed & Draw-out Type).....	133
• Control Desks.....	134
• IT Racks - 19" and ETSI Racks.....	135
• Non Metallic Enclosures.....	138

Wires & Cables

• 3-Core Flat Cables for Submersible Pump Applications	142
• Single core FR & FRLSH wire	143
• Multicore PVC flexible cable	144
• Shielded cable & steel braided cable	145

Power Quality & Energy Management

• LT Power Capacitors	147
• Super Heavy Duty Capacitors,	148
• APFC Relay, Detuned Reactors	149

Electric Motors

• High Efficiency Motors - General Purpose	150
• Premium Efficiency Motors - General Purpose	150
• High Efficiency Motors - Inverter Duty	150
• Premium Efficiency Motors - Inverter Duty	150

Switchboards & Solutions

• MCC & PCC	152
• APFC Panels	153
• Crane Control Panels	154
• Punch Grid Resistors & Panels, NGR & DBR	154
• Special Purpose Starters	154
• Power Receptacles	155
• Auto Transformer Starters	156

Complete range of
CIRCUIT BREAKERS

ULTRA 
POWER
Air Circuit Breakers



BCH
ELECTRIC
LIMITED

Power Distribution

- Air Circuit Breakers
- MCCBs
- X-Line SDF, FSU, SDFU
- Polycarbonate Plug & Socket BPX Serie
- Plug & Sockets
- Plug & Socket Boxes





Range of Air Circuit Breakers

- Complete range conforms to IS/IEC 60947-2
- Current rating from 800A to 6300A in 3 frame sizes
- Available in 3 Pole/4 Pole, Manually & Electrically operated, Fixed/Draw-out version
- Common Height & Depth across the range
- High short time fault withstand capacity, $I_{cu} = I_{cs} = I_{cw}$ for 1 sec for total selectivity
- High mechanical and electrical operating life
- Neutral pole is 100% rated
- In-built Electrical & Mechanical Anti-Pumping
- Modular & snap-fit accessories
- Ease of on-site conversion from Fixed to Draw-out version
- Pollution Degree 4 suitability
- Best in Class Overlap with Bus bars
- Break Time of 25msec
- RoHS Compliant



Basic Version



BU - BTX 1.0/1G/1Gi BU - BTX 1.5G/1.5Gi

Advanced Version



BU - BTX 3.5/3.5EC BU - BTX 3.5H BU - BTX 4.5

BTX Release for Protection & Control Unit:

- Available in versions - BTX1.0/1G/1Gi/1.5G/1.5Gi, BTX3.5/3.5H & BTX4.5
- Unique O-LED display for metering
- Touch screen technology in BU-BTX4.5
- Dual withdrawable Communication & Power metering modules
- Dual protection curve settings & Password protection
- Soft-rating plug for precise protection at lower load currents
- Provision for on-load self-diagnosis of Releases & modules
- Power & Harmonics measurement
- Temperature rise monitoring & protection
- Easy to integrate with HMI & PLC
- Add-on modules for advance protections
- Protection Releases conform to EMI/EMC standard

Breaking Capacities:

$I_{cu} = I_{cs} = I_{cw}$

Rated current	800A	1000A	1250A	1600A	2000A	2500A	3200A	4000A	5000A	6300A
N : 50kA	■	■	■	■	■	■	■			
S : 65kA	■	■	■	■	■	■	■			
H : 80kA							■	■		
V : 100kA									■	■
	BU1-08	BU1-10	BU1-12	BU1-16	BU1-20	BU2-25	BU2-32	BU2-40	BU3-50	BU3-63
	Frame-1					Frame-2			Frame-3	

ULTRA POWER ACB ordering information: Air Circuit Breakers

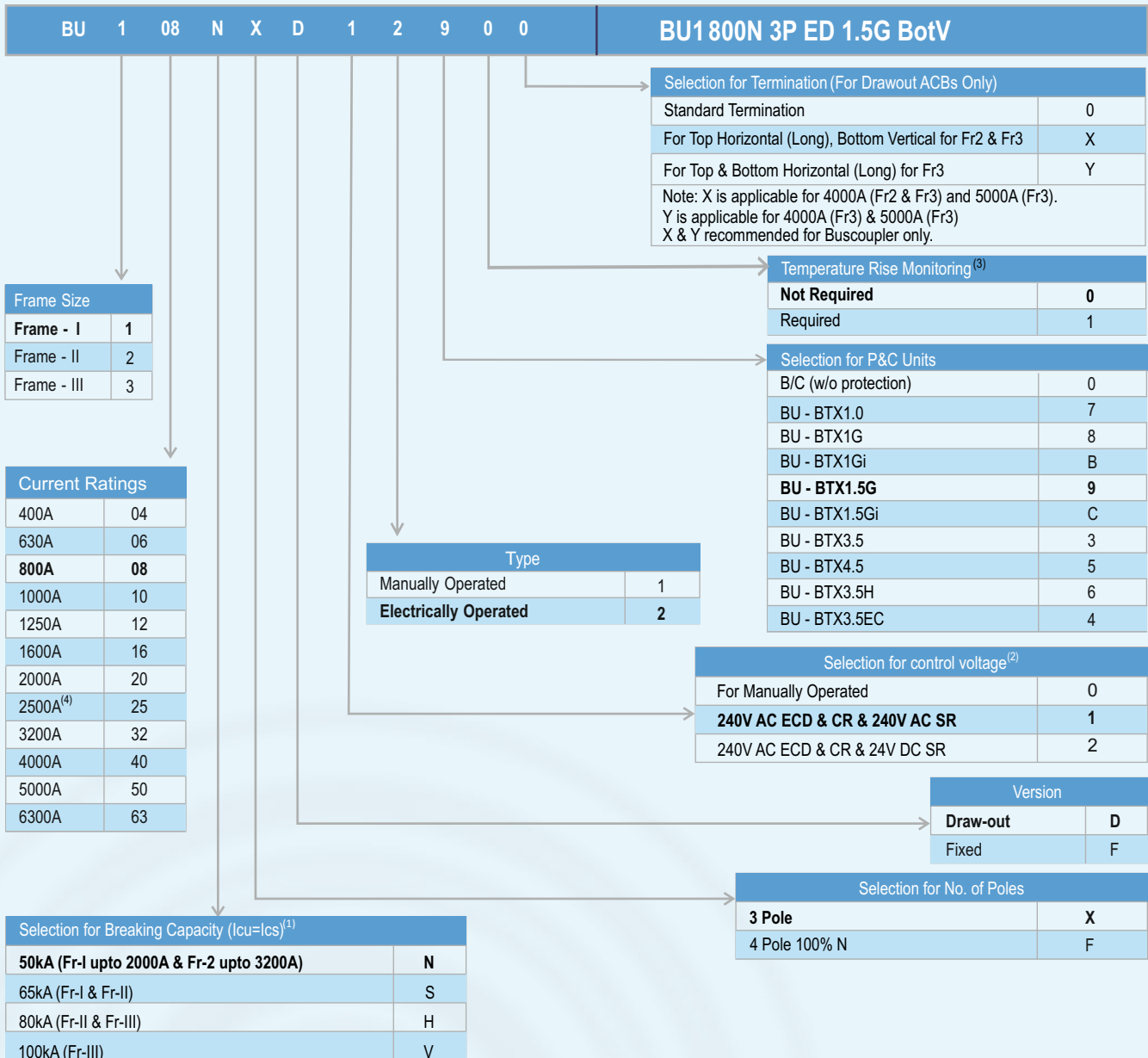

Please Note : (1) For low values please refer product catalogue
 (2) Other options of control voltage are available as accessory
 (3) Temperature protection is available in BU-BTX3.5/3.5H/4.5
 (4) For Fr-1, 2500A selection, please contact the nearest branch

ULTRA POWER ACBs are offered with following standard features:

Draw-out Version: Ultra power ACBs with BU-BTX release will have inbuilt- Current Metering (BTX 1.5G/1.5Gi/3.5/3.5EC/3.5H/4.5), Common Fault Indication microswitch, 4NO+4NC Aux. contacts, Smart-racking shutter, Safety shutter assembly, Racking Handle, Door sealing frame, Pad-locking arrangement for ON/OFF button, Rating Error Preventer, Arc shield.
 A) For ratings upto 1600A, one side vertical terminal adaptors (Bottom) for Frames 1, 2 & 3.
 B) For ratings 2000A & above, both side vertical terminal adaptors (Top & Bottom) for Frames 1, 2 & 3.
 C) For rating 4000A and above, operation counter inbuilt for Frames 2 & 3 both.

Fixed Version: Ultra power ACBs with BU-BTX release will have inbuilt- Current Metering (1.5G/1.5Gi/3.5/3.5EC/3.5H/4.5), Common Fault Indication microswitch, 4NO+4NC Aux. contacts, Door sealing frame & Pad-locking arrangement for ON/OFF push button.
 A) For ratings upto 1600A, one side vertical terminal adaptors (Bottom) for Frame 1, 2 & 3.
 B) For ratings 2000A & above, both side vertical terminal adaptors (Top & Bottom) for Frames 1, 2 & 3.
 C) For rating 4000A and above, operation counter inbuilt for Frames 2 & 3 both.
 Electrically operated ACB includes ECD (240V AC), CR (240V AC) & SR (240V AC OR 24V DC).

ULTRA POWER ACBs with BU-BTX1G (LSING - BCD Switches) - 3 Pole Air Circuit Breakers



HSN Code : 8536

Current Rating	Version	3 Pole Manual Draw-out ACB with BU-BTX1G											
		N (50kA)		S (65kA)		H (80kA)		V (100kA)					
		Cat. No.	M.R.P. [₹]	Cat. No.	M.R.P. [₹]	Cat. No.	M.R.P. [₹]	Cat. No.	M.R.P. [₹]				
800A	MDO	BU108NXD01800	*	BU108SXD01800	*	-	-	-	-				
1000A		BU110NXD01800		BU110SXD01800									
1250A		BU112NXD01800		BU112SXD01800									
1600A		BU116NXD01800		BU116SXD01800									
2000A		BU120NXD01800		BU120SXD01800									
2500A		BU225NXD01800		BU225SXD01800									
3200A		-		BU232SXD01800						BU232HXD01800	*		
4000A		-		-						BU240HXD01800			
5000A		-		-						-	-	BU350VXD01800	*
6300A		-		-						-	-	BU363VXD01800	

HSN Code : 8536

Current Rating	Version	3 Pole Manual Fixed ACB with BU-BTX1G			
		N (50kA)		S (65kA)	
		Cat. No.	M.R.P. [₹]	Cat. No.	M.R.P. [₹]
800A	MF	BU108NXF01800	*	-	-
1000A		BU110NXF01800		BU110SXF01800	*
1250A		BU112NXF01800		BU112SXF01800	
1600A		BU116NXF01800		BU116SXF01800	
2000A		BU120NXF01800		BU120SXF01800	
2500A		BU225NXF01800		BU225SXF01800	
3200A		BU232NXF01800		BU232SXF01800	



M.R.P. changes for product customization	M.R.P. [₹]
MDO to EDO or MF to EF conversion (Includes ECD 240V AC, CR 240V AC & SR 240V AC or 24V DC)	*
Buscoupler (without protection release)	
BU-BTX1.0 (LSI - BCD Switches)	
BU-BTX1Gi (LSING + Inbuilt ZSI - BCD Switches)	
BU-BTX1.5G (LSING + Current Metering - BCD Switches)	
BU-BTX1.5Gi (LSING + Current Metering + Inbuilt ZSI - BCD Switches)	
BU-BTX3.5 (LSING + Current Metering) + can be upgraded for Power Metering & Communication	
BU-BTX3.5EC (LSING + Power Metering + Communication)	
BU-BTX3.5H (LSING + Power Metering + Harmonic Metering)	
BU-BTX4.5 (LSING + Power Metering + Harmonic Metering + Communication with Touch Screen navigation + BU-PS Module)	
BU-PS (Auxiliary power supply module for display in No-load or OFF condition)	
COM Module (MODBUS) for communication	
PM Module for power metering	

* Available on request



ULTRA POWER ACBs with BU-BTX1G (LSING - BCD Switches) - 4 Pole Air Circuit Breakers



HSN Code : 8536

Current Rating	Version	4 Pole Manual Draw-out ACB with BU-BTX1G								
		N (50kA)		S (65kA)		H (80kA)		V (100kA)		
		Cat. No.	M.R.P. [₹]	Cat. No.	M.R.P. [₹]	Cat. No.	M.R.P. [₹]	Cat. No.	M.R.P. [₹]	
800A	MDO	BU108NFD01800	*	-	-	-	-	-	-	
1000A		BU110NFD01800		BU110SFD01800						
1250A		BU112NFD01800		BU112SFD01800						
1600A		BU116NFD01800		BU116SFD01800						
2000A		BU120NFD01800		BU120SFD01800						
2500A		BU225NFD01800		BU225SFD01800						
3200A		BU232NFD01800		BU232SFD01800	BU232HFD01800					*
4000A		-		-	BU240HFD01800					
5000A		-	-	-	-	BU350VFD01800	*			
6300A		-	-	-	-	BU363VFD01800				

HSN Code : 8536

Current Rating	Version	4 Pole Manual Fixed ACB with BU-BTX1G			
		N (50kA)		S (65kA)	
		Cat. No.	M.R.P. [₹]	Cat. No.	M.R.P. [₹]
800A	MF	BU108NFF01800	*	-	-
1000A		BU110NFF01800		BU110SFF01800	
1250A		BU112NFF01800		BU112SFF01800	
1600A		BU116NFF01800		BU116SFF01800	
2000A		BU120NFF01800		BU120SFF01800	
2500A		BU225NFF01800		BU225SFF01800	
3200A		BU232NFF01800		BU232SFF01800	



Accessories of Air Circuit Breakers

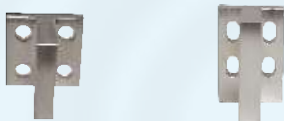

Draw-out ACBs Terminal Adaptors

HSN Code : 8538

Description	Cat. No.	M.R.P. [₹]
Terminal Adaptor for Draw-out ULTRA ACBs		
Frame-1 400-2000A N/S/H (Vertical / Horizontal)	BLCA609630000	*
Frame-2 400-3200A N/S/H (Vertical / Horizontal)	BLCA609640000	



Operation Counter



Door Interlock

HSN Code : 8538

Description	Cat. No.	M.R.P. [₹]
Other Accessories		
Operation Counter	BLOC909830000	*
Door Interlock	BLDI909780000	
Electrical Position Indication (EPI)	BLEPI958260000	
Microswitches for Indication		
Microswitch for Common Fault Indication (CFI)	BLCM909490000	*
Microswitch for Ready To Close Indication (RTC)	BLRCM909530000	
Microswitch for Shunt Release	BLSM909510000	
Microswitch for Undervoltage Release	BLUM909470000	
Microswitch for Spring Charging Indication	BLMSC426720000	

* Available on request



Accessories of Air Circuit Breakers



R-Lock



C-Lock



Closing Release



Shunt Release



UV Release

HSN Code : 8538

Description	Cat. No.	M.R.P. [₹]
Mechanical Interlock using Key & Lock		
R - Lock Type - 1	BLRL1006590000	*
R - Lock Type - 2	BLRL2006600000	
R - Lock Type - 3	BLRL3006610000	
R - Lock Type - 12	BLRL12006620000	
R - Lock Type - 23	BLRL23006630000	
Locking arrangement for OFF button with R - Lock (on breaker)	BLRL908150000	
Locking arrangement for ISO position with R - Lock (on Cradle)	BLCLR908650000	
Locking arrangement for ANY position with R - Lock (on Cradle)	BLCLR909270000	
C - Lock Type - S	BLCLS006640000	
C - Lock Type - T	BLCLT006650000	
C - Lock Type - ST	BLCLST006660000	
C - Lock Type - SS	BLCLSS006670000	
C - Lock Type - TT	BLCLTT006680000	
Locking arrangement for OFF button with C - Lock (on breaker)	BLCL908140000	
Locking arrangement for ISO position with C - Lock (on Cradle)	BLCLC909820000	
Locking arrangement for ANY position with C - Lock (on Cradle)	BLCLC909810000	

Note : For mechanical interlock using Key & Lock, please order combination of lock & locking arrangement

HSN Code : 8538

Description	Cat. No.	M.R.P. [₹]	
Electrical Charging Device (ECD)			
240V AC / 250V DC	BLECD903590000	*	
415V AC / 400V DC	BLECD903610000		
Closing Release (CR)			
220 - 240V AC / 220 - 250V DC	BLCR90817B000		
415V AC	BLCR90817D000		
Shunt Release (SR)			
24-30V DC	BLSH908160400		
220 - 240V AC / 220 - 250V DC	BLSH908160B00		
415V AC	BLSH908160D00		
Under Voltage Release (UVR) with time delay (0-1-3-5 sec)			
240V AC / 220V DC	BLUV90818B000		
415V AC	BLUV90818D000		

HSN Code : 8538

Description	Cat. No.	M.R.P. [₹]
External Neutral CT for BU-BTX Releases		
Frame-1, 800A	BLEN007170000	*
Frame-1, 1000-1600A	BLEN007180000	
Frame-1 2000A	BLEN007190000	
Frame-2 & 3 2500-4000A	BLNCT007200000	

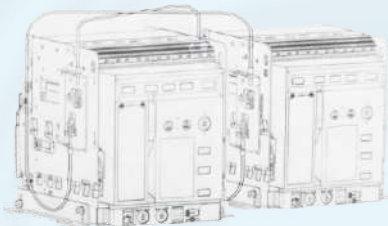

Mechanical Interlock using Bowden Cable

HSN Code : 8538

Description	Cat. No.	M.R.P. [₹]
Mechanical Interlock using Bowden Cable (3 meters length)		
Between 2 Incomers	BLBC906590000	*
Between 2 Incomers & 1 Buscoupler	BLBC906620000	

Note : Common from 800A to 5000A & can be interlocked between fixed / drawout / mixed version



BU-BTX1.5G



BU-BTX3.5

HSN Code : 8538

Description	Cat. No.	M.R.P. [₹]
BTX Releases		
BU-BTX1G	BLBTX919710000	*
BU-BTX1Gi	BLBTX905620000	
BU-BTX1.5G	BLBTX919650000	
BU-BTX1.5Gi	BLBTX905520000	
BU-BTX3.5	BLBTX901130000	
BU-BTX3.5EC	BLBTX906440000	
BU-BTX3.5H	BLBTX919750000	
Simulation Kit	BLSK907240000	

* Available on request





S1 Range of Air Circuit Breakers

- Conforms to IS/IEC 60947-2
- Current rating from 800A to 6300A
- Available in 3 Pole/4 Pole, Manually & Electrically operated, Fixed & Draw-out versions
- High short time withstand capacity, $I_{cu} = I_{cs} = I_{cw}$ for 1 sec for total selectivity
- High mechanical and electrical operating life
- 100% rated neutral pole
- Common height and depth across the range
- Protection through Microprocessor releases (BR18G)
- Self diagnostic Microprocessor based Releases with on-load testing through TEST button
- Inbuilt thermal memory
- Protection Releases conform to EMI/EMC standards



Mega power S1 ACB

Breaking Capacities Offered:

Icu = Ics = Icw for 1 sec										
	800A	1000A	1250A	1600A	2000A	2500A	3200A	4000A	5000A	6300A
Frame : S1	50kA	50kA	50kA	50kA	50kA	60kA				
Frame : H2							75kA	75kA		
Frame : C									95kA	95kA
	Frame-1				Frame-2		Frame-3		Frame-4	

MEGA POWER S1 3 & 4 Pole Draw-out ACBs

HSN Code : 8536

Rating	Breaking Capacity $I_{cu}=I_{cs}=I_{cw}$ (1 sec)	Version	Microprocessor Based BR18G			
			3 Pole		4 Pole	
			Cat. No.	M.R.P.[₹]	Cat. No.	M.R.P.[₹]
800A	50kA	MDO	BM960420000	225495	BM960620000	282890
800A	50kA	EDO	BM960520000	279655	BM960720000	337055
1000A	50kA	MDO	BM960430000	234460	BM960630000	296325
1000A	50kA	EDO	BM960530000	288620	BM960730000	350480
1250A	50kA	MDO	BM960440000	258720	BM960640000	326320
1250A	50kA	EDO	BM960540000	312885	BM960740000	380485
1600A	50kA	MDO	BM960450000	294965	BM960650000	362775
1600A	50kA	EDO	BM960550000	349130	BM960750000	416935
2000A	50kA	MDO	BM960460000	346425	BM960660000	425580
2000A	50kA	EDO	BM960560000	400585	BM960760000	479740
2500A	60kA	MDO	BM960470000	428295	BM960670000	516195
2500A	60kA	EDO	BM960570000	482445	BM960770000	570355

MEGA POWER S1 3 & 4 Pole Fixed ACBs

HSN Code : 8536

Rating	Breaking Capacity $I_{cu}=I_{cs}=I_{cw}$ (1 sec)	Version	Microprocessor Based BR18G			
			3 Pole		4 Pole	
			Cat. No.	M.R.P.[₹]	Cat. No.	M.R.P.[₹]
630A	50kA	MF	BM955610000	138320	BM955810000	176330
630A	50kA	EF	BM955710000	192485	BM955910000	230495
800A	50kA	MF	BM955620000	138320	BM955820000	176330
800A	50kA	EF	BM955720000	192485	BM955920000	230495
1000A	50kA	MF	BM955630000	151135	BM955830000	190705
1000A	50kA	EF	BM955730000	205295	BM955930000	244870
1250A	50kA	MF	BM955640000	174045	BM955840000	217475
1250A	50kA	EF	BM955740000	228205	BM955940000	271640
1600A	50kA	MF	BM955650000	193005	BM955850000	248205
1600A	50kA	EF	BM955750000	247165	BM955950000	302370

MEGA POWER MEGA POWER H2 3 & 4 Pole Draw-out ACBs

Air Circuit Breakers



HSN Code : 8536

Rating	Breaking Capacity Icu=Ics=Icw (1 sec)	Version	Type	Microprocessor Based BR18G			
				3 Pole		4 Pole	
				Cat. No.	M.R.P. [₹]	Cat. No.	M.R.P. [₹]
3200A	75kA	MDO	H2	BM948220000	575135	BM948260000	705870
3200A	75kA	EDO	H2	BM948240000	630850	BM948280000	761595
4000A	75kA	MDO	H2	BM948230000	659675	BM948270000	839930
4000A	75kA	EDO	H2	BM948250000	715400	BM948290000	895645
5000A	95kA	MDO/EDO	C	On request		On request	
6300A	95kA	MDO/EDO	C	On request		On request	

M.R.P. changes for	M.R.P. [₹]
product customization w.r.t. BR18G M.R.P.	
Bus-Coupler (w/o protection)	Reduce -13520

MEGA POWER ACBs are offered with following standard features:

Mega Power S1 Draw-Out ACB's will have inbuilt - 2NO+2NC Aux contact for MDO & 6NO+6NC Aux contact for EDO breakers, Safety shutter assembly, Racking handle, Door sealing frame, Push-button cover & Rating error preventor.

Mega Power S1 Fixed ACB's will have inbuilt - 2NO+2NC Aux contact for MF & 6NO+6NC Aux contact for EF breakers, Door sealing frame & Push-button cover. Electrical version includes 240V AC Shunt trip coil, Closing coil and Motor for electrical charging.

Accessories for Mega Power ACB's



LTPB



Shunt Release



UV Release

HSN Code : 8538

HSN Code : 8538

Description	Cat. No.	M.R.P. [₹]
Lockable Trip Push Button (LTPB)		
Type AA	BMLP93148000A	5605
Type BB	BMLP93148000B	5605
Type CC	BMLP93148000C	5605
Type DD	BMLP93148000D	5605
Locking of ACB in Any position (LAP)		
Type A	BMLP93147000A	5605
Type B	BMLP93147000B	5605
Type C	BMLP93147000C	5605
Type D	BMLP93147000D	5605
Racking Interlock		
Type AA	BMRI93149000A	7720
Type B B	BMRI93149000B	7720
Type C C	BMRI93149000C	7720
Type D D	BMRI93149000D	7720
Other Accessories		
Door Interlock	BMDI931500000	4115

Description	Cat. No.	M.R.P. [₹]
Shunt Release (SR)		
Type EA : 24/48V DC	BMSH927180400	4225
Type EA1 : 240V AC	BMSH927180B00	4225
Type EA1 : 415V AC	BMSH927180D00	4225
Under Voltage Release (UVR)		
Type MV : 240V AC	BMUV92720B000	6320
Type MV : 415V AC	BMUV92720D000	6320
Microswitches for Indication		
Test or Isolated Position Microswitch - Left (2)	BMTL931450000	2345

Note :

- The Numerical in brackets, against various accessories indicate the SICs required for wiring purpose in Draw-Out breakers
- Shunt release requires one set of auxiliary contacts
- Maximum 24 SICs can be fitted on an ACB. In Electrical ACBs 5 SICs are prewired for control circuit purpose

HSN Code : 8538

Description	Cat. No.	M.R.P. [₹]
Protection Releases		
Microprocessor based type BR18G	BMBR960300000	51590



XF Frame 1 / XD0 / XA1 With Thermal - Magnetic Release:

RATING (A) Icu (kA)	16	20	25	32	40	50	63	80	100	125
10/ 25/ 50	XF Frame 1 - 3 Pole									
18	XA1 - 4 POLE									



- Conforms to IS/IEC 60947-2
- Range: 16A - 125A
- High Performance Compact Size
- Suitability for Isolation
- Rated at 50°C
- Line Load Interchangeability
- Double Insulation
- Thermal Magnetic Trip unit
- Overload Setting: 0.7-1.0 In
- Short Circuit Setting: Fixed

HSN Code : 8536

Type	Release Range (A)	Breaking Capacity Icu/lcs at 415V AC	3 Pole		Type	4 Pole		Std. Pkg.
			Cat. No.	MRP [₹]		Cat. No.	MRP [₹]	
XF Frame1	16A	10/10kA (Fixed)	XFE016P	2945	XF Frame1	XFE016P4	4895	1
	20A		XFE020P			XFE020P4		
	25A		XFE025P			XFE025P4		
	32A		XFE032P			XFE032P4		
	40A		XFE040P			XFE040P4		
	50A		XFE050P			XFE050P4		
	63A		XFE063P			XFE063P4		
	80A <small>(w/o spreader terminal)</small>		XFE080WT			XFE080P4-WT		
	80A		XFE080P#			XFE080P4#		
	100A <small>(w/o spreader terminal)</small>		XFE100P-WT			XFE100P4-WT		
	100A		XFE100P#			XFE100P4#		
	125A		XFE125P#			XFE125P4#		
						XD0		

HSN Code : 8536

HSN Code : 8536

Type	Release Range (A)	Breaking Capacity Icu/lcs at 415V AC	3 Pole		Std. Pkg.	Type	Release Range (A)	Breaking Capacity Icu/lcs at 415V AC	4 Pole		MRP [₹]	Std. Pkg.
			Cat. No.	MRP [₹]					Cat. No.	MRP [₹]		
XF Frame1	125 <small>(w/o spreader terminal)</small>	18/18kA	XFR***PV-WT	9610	1	XA1	32	18/18kA	XA1R032PV4	9825	1	
	125		XFR***PV#	10135	1		40		XA1R040PV4	9825	1	
	16A	XFE016P	9650		63		XA1R063PV4		9545	1		
	20A	XFE020P	9650		100 <small>(w/o spreader terminal)</small>		XA1R100PV4		9545	1		
	25A	XFE025P	9650		125 <small>(w/o spreader terminal)</small>		XA1R125PV4		12105	1		
	32A	XFE032P	9650									
	40A	XFE040P	9650									
	50A	XFE050P	9650									
	63A	XFE063P	9650									
	80A <small>(w/o spreader terminal)</small>	XFE080P-WT	9330									
	80A	XFE080P#	9820									
	100A <small>(w/o spreader terminal)</small>	XFE100P-WT	9330									
	100A	XFE100P#	9820									
	125A <small>(w/o spreader terminal)</small>	XFE125P-WT	12515									
	125A	XFE125P#	14035									
	32A	50/50kA	XFV032PV	16880								
	40A		XFV040PV	16880								
	50A		XFV050PV	16880								
	63A		XFV063PV	16880								
	80A		XFV080PV#	17120								
100A <small>(w/o spreader terminal)</small>	XFV100PV-WT		16745									
100A	XFV100PV#		17120									

Note: - Phase barriers are supplied along with all MCCBs.
For accessories please refer page No.16 on Table3, 4 & 5
- Spreader terminals available as accessories.
- Overload setting XF Frame1 - Fixed / XD0 : 0.8-1.0 x In

Note: Phase barriers are supplied along with all MCCBs.
#Spreader terminals available as standard.
(For MCCB without spreader, please contact our nearest branch)
For accessories please refer page No.16 on Table1 & 2

XF2/XA2 With Thermal - Magnetic Release:

RATING (A) Icu (kA)	125	160	200	250
25	XF2 - 3 Pole			
36	XF2 - 3 Pole			
50	XF2 - 3 Pole			

XF2 Frame - 3 Pole

- Conforms to IS/IEC 60947-2
- Range: 125A - 250A
- High Performance Compact Size
- Suitability for Isolation
- Rated at 50 C °
- Line Load Interchangeability
- Double Insulation
- Thermal Magnetic Trip unit
 - Overload Setting: 0.8-1.0 In
 - Short Circuit Setting: Fixed



XF2 Frame :
I_{cu}/I_{cs} = 25/25, 36/18, 36/27,
36/36, 50/25, 50/50 kA

HSN Code : 8536

Type	Release Range (A)	Breaking Capacity Icu/Ics at 415V AC	3 Pole		Std. Pkg.
			Cat. No.	MRP [₹]	
XF Frame 2	160A <small>(w/o spreader terminal)</small>	25/25kA	XF2E160PV	18815	1
	200A <small>(w/o spreader terminal)</small>		XF2E200PV-WT	22400	1
	200A		XF2E200PV#	23970	1
	250A <small>(w/o spreader terminal)</small>		XF2E250PV-WT	25755	1
	250A		XF2E250PV#	27560	1
	125A <small>(w/o spreader terminal)</small>		XF2N125PV	18850	1
	160A <small>(w/o spreader terminal)</small>	XF2N160PV	25095	1	
	200A <small>(w/o spreader terminal)</small>	XF2N200PV-WT	27225	1	
	200A	XF2N00PV#	29130	1	
	250A <small>(w/o spreader terminal)</small>	XF2N250PV-WT	30235	1	
	250A	XF2N250PV	32205	1	
	125A <small>(w/o spreader terminal)</small>	XF2H125PV	26965	1	
	160A <small>(w/o spreader terminal)</small>	XF2H160PV	30330	1	
	200A <small>(w/o spreader terminal)</small>	XF2H200PV-WT	30535	1	
	200A	XF2H200PV#	32505	1	
	250A <small>(w/o spreader terminal)</small>	XF2H250PV-WT	33350	1	
	250A	XF2H250PV#	35320	1	

Note: Phase barriers are supplied along with all MCCBs.

#Spreader terminals available as standard.

(For MCCB without spreader, please contact our nearest branch)

For accessories please refer page No.16 on Table1 & 2

XF3/XA3 With Thermal - Magnetic Release:

RATING (A) Icu (kA)	320	400	500	630
36	XF3 - 3 Pole			
50	XF3 - 3 Pole			

HSN Code : 8536

XF3 Frame - 3 Pole

- Conforms to IS/IEC 60947-2
- Range: 320A - 630A
- High Performance Compact Size
- Suitability for Isolation
- Rated at 50 C °
- Line Load Interchangeability
- Double Insulation
- Thermal Magnetic Trip unit



XF3 Frame :
I_{cu}/I_{cs} = 36/36, 50/50 kA

Type	Release Range (A)	Breaking Capacity Icu/Ics at 415V AC	3 Pole		Std. Pkg.
			Cat. No.	MRP [₹]	
XF3 range	320	36/36kA	XF3N320PV	38540	1
	400		XF3N400PV	40440	1
	500		XF3N500PV	48955	1
	630		XF3N630PV	53435	1
	320	50/50kA	XF3H320PV	42980	1
	400		XF3H400PV	44065	1
	500		XF3H500PV	56805	1
	630		XF3H630PV	56835	1

Note: Phase barriers are supplied along with all MCCBs.

Spreader terminals available as standard.

(For MCCB without spreader, please contact our nearest branch)

For MCCBs with 'Magnetic only' protection, prices available On Request.

For accessories please refer page No.16 on Table1 & 2

YG1/XB Range With Thermal - Magnetic Release:

RATING (A) Icu=Ics (kA)	100	125	160	200	250	320	400	630
25	XB0 - 4 Pole							
25		XB1 - 4 Pole						
36	XB0 - 4 Pole			XB2 - 4 Pole		XB3S - 4 Pole		
36		YG1 - 4 Pole				XB3 - 4 Pole		XB3 - 4 Pole
50		YG1 - 4 Pole						XB3 - 4 Pole
50				XB2 - 4 Pole		XB3 - 4 Pole		

YG1 Frame - 4 Pole

- Conforms to IS/IEC 60947-2
- 84A to 160A, 4P
- 36kA & 50kA breaking capacities
- Ics = 100% of Icu
- Adjustable overload settings: 0.67 - 1.0 x In
- Adjustable short-circuit settings: 6 - 12 x In
- Transparent sealable release cover
- Compact size
- Wide range of accessories



YG1 Frame :
I_{cu}/I_{cs} = 36/36, 50/50 kA

XB Range - 4 Pole

- Conforms to IS/IEC 60947-2
- 80A to 630A, 4P
- 25kA, 36kA, 50kA breaking capacities
- Ics = 100% of Icu*
- Adjustable overload settings: 0.8 - 1.0 x In
- Manual, Rotary and Motorised versions available@
- Adjustable short-circuit settings: 6 - 10 x In**
- Wide range of accessories



XB Frame :
I_{cu}/I_{cs} = 25/25, 36/18, 36/36, 50/50 kA

YG1/XB Range With Thermal - Magnetic Release - 4 Pole

HSN Code : 8536

Type	Release	Breaking Capacity Icu/Ics	4 Pole		Std. Pkg.	
	Range (A)		Cat. No.	MRP [₹]		
XB0	20	25/25kA	XB0S020PV4	14120	1	
	25		XB0S025PV4	14120	1	
	32		XB0S032PV4	14120	1	
	40		XB0S040PV4	14120	1	
	63		XB0S063PV4	13840	1	
	100		XB0S100PV4	13840	1	
	125		XB1E125PV4	17630	1	
XB1	160		XB1E160PV4	22630	1	
	200		XB1E200PV4	28475	1	
XB1	250		XB1E250PV4	32435	1	
	100		36/36kA	XG1N100PV4	16475	1
XG1	125			XG1N125PV4	18355	1
	160			XG1N160PV4	23220	1
	200			XB2N200PV4	34915	1
XB2	250	XB2N250PV4		36980	1	
	320	XB3SN320PV4		45550	1	
XB3S	400	XB3SN400PV4		45550	1	
	320	XB3N320PV4		58100	1	
XB3	630	XB3N630PV4		63010	1	
	100	50/50kA		XG1H100PV4	20460	1
XG1	125			XG1H125PV4	25645	1
	160			XG1H160PV4	30190	1
	200			XB2H200PV4	40785	1
XB2	250			XB2H250PV4	42190	1
	320		XB3H320PV4	50890	1	
XB3	400		XB3H400PV4	50890	1	
	630		XB3H630PV4	71095	1	

General Information

- Use of phase barriers is mandatory. These are supplied along with MCCBs
- It is recommended to use spreader terminals for enhancing termination capacity
- Spreader terminals are available as accessories, unless otherwise specified against cat. nos.

@ Motorized version available for XB2 AND XB3 Frames

* XB0 : Ics = 50% Icu

** For XB0, XB1, XB3S Short circuit setting : 9 In

Special Applications

- XB range MCCBs with TM release can be used for DC application (4 Pole)
- XB range MCCBs can be used for Capacitor back-up protection

For accessories please refer page No.16 on Table3, 4 & 5

YG1/XB Range With Microprocessor Release:

RATING (A) I _{cu} =I _{cs} (kA)	40	63	100	160	250	320	400	500	630	800	1000	1250	
36/36	YG1-LSI/LSIG (3 & 4 Pole)												
	XF2 RANGE-LSIG (3 Pole)												
			XB2-LSI/LSIG (3 & 4 Pole)						XF3 RANGE-LSIG (3 Pole)				
					XB3-LSI/LSIG (3 & 4 Pole)								
							XB3-LSI/LSIG (3 & 4 Pole)						
50/50	YG1-LSI/LSIG (3 & 4 Pole)												
	XF2 RANGE-LSIG (3 Pole)												
			XB2-LSI/LSIG (3 & 4 Pole)						XF3 RANGE-LSIG (3 Pole)				
					XB3-LSI/LSIG (3 & 4 Pole)								
							XB3-LSI/LSIG (3 & 4 Pole)				XB4-LSI/LSIG (4 Pole)		

With Microprocessor Release BMR & GMR - LSI (3 & 4 Pole)



XB Frame - BMR :
I_{cu}/I_{cs} = 36/36, 50/50 kA

XB-BMR (LSI)

- Conforms to IS/IEC 60947-2
- 250A to 1250A, 3P & 4P
- 36kA, 50kA breaking capacities
- Adjustable overload setting from 0.4 to 1.0 x I_n
- I_{cs}=100% I_{cu}
- Adjustable short-circuit setting from 1.5 to 8 x I_r
- Inbuilt instantaneous Protection
- Switchable thermal memory
- Variable trip class
- Front LED Indication
- Manual, Rotary and Motorised versions available@
- Wide range of accessories



YG1 Frame - GMR :
I_{cu}/I_{cs} = 36/36, 50/50 kA

YG1-GMR (LSI)

- Conforms to IS/IEC 60947-2
- 16A to 160A, 3P & 4P
- 36kA & 50kA breaking capacities
- I_{cs}=100% I_{cu}
- Adjustable overload setting from 0.25 to 1.0 x I_n
- Adjustable short-circuit setting from 1.5 to 12 x I_n
- Instantaneous setting from 1.5 to 12 x I_n
- Switchable thermal memory
- Variable trip class
- Transparent sealable release cover
- Compact size
- Adjustable overload setting from 0.25 to 1.0 x I_n
- Wide range of accessories

HSN Code : 8536

Type	Release Range (A)	Breaking Capacity I _{cu} /I _{cs}	3 Pole		4 Pole		Std. Pkg.
			Cat. No.	MRP [₹]	Cat. No.	MRP [₹]	
YG1	10-40	36/36kA	YG1L040PE3-LSI	23905	YG1L040PE4-LSI	28420	1
	16-63		YG1L063PE3-LSI	22665	YG1L063PE4-LSI	28420	1
	25-100		YG1L100PE3-LSI	22665	YG1L100PE4-LSI	28420	1
	40-160		YG1N160PE3-LSI	28640	YG1N160PE4-LSI	39805	1
XB2	100-250	36/36kA	XB2N250PE3-LSI	39880	XB2N250PE4-LSI	54640	1
XB3	160-400	36/36kA	XB3N400PE3-LSI	49010	XB3N400PE4-LSI	60615	1
	250-630		XB3N630PE3-LSI	54640	XB3N630PE4-LSI	71095	1
YG1	10-40	50/50kA	YG1V040PE3-LSI	27495	YG1V040PE4-LSI	36040	1
	16-63		YG1V063PE3-LSI	26980	YG1V063PE4-LSI	36040	1
	25-100		YG1V100PE3-LSI	26980	YG1V100PE4-LSI	36040	1
	40-160		YG1H160PE3-LSI	35275	YG1H160PE4-LSI	44555	1
XB2	100-250	50/50kA	XB2H250PE3-LSI	46140	XB2H250PE4-LSI	58470	1
XB3	160-400	50/50kA	XB3H400PE3-LSI	53630	XB3H400PE4-LSI	69295	1
	250-630		XB3H630PE3-LSI	58925	XB3H630PE4-LSI	76830	1
XB4	320-800	50/50kA	XB4H800PE3-LSI	88485	XB4H800PE4-LSI	111425	1
	400-1000		XB4H1000PE3-LSI	123810	XB4H1000PE4-LSI	179240	1
	500-1250		XB4H1250PE3-LSI	154570	XB4H1250PE4-LSI	209095	1

@ Motorized version available for XB2 and XB3 Frames (please refer page no.16)

For accessories please refer page No.16 on Table3, 4 & 5

General Information

- Use of phase barriers is mandatory. These are supplied along with MCCBs
- It is recommended to use spreader terminals for enhancing termination capacity
- Spreader terminals are available as accessories, unless otherwise specified against cat. nos.

XF3 Range With Microprocessor Release - LSIG (3 Pole)

HSN Code : 8536



XF2 & XF3 Frame - LSIG :
I_{cu}/I_{cs} 36/36, 50/50 kA

• Electronic Trip Unit (ETU)-LSIG

- Overload Setting: 0.4-1.0 In
- Short Circuit Setting: 1.5-10 In
- Earth Fault Setting: 0.2-0.55 In
- Instantaneous Setting: 12 In
- Short Circuit Delay: 50-500 ms
- Earth Fault Delay: 50-500 ms
- Pre Trip Alarm Indication



XB Frame - BMR :
I_{cu}/I_{cs} 36/36, 50/50 kA

Type	Release Range (A)	Breaking Capacity I _{cu} /I _{cs} at 415V AC	3 Pole		Std. Pkg.
			Cat. No.	MRP [₹]	
XF2 range	16 - 40	36/36kA	XF2N040PE-LSIG	39650	1
	25 - 63		XF2N063PE-LSIG	39650	1
	40 - 100		XF2N100PE-LSIG	39650	1
	63 - 160		XF2N160PE-LSIG	45050	1
	100 - 250		XF2N250PE-LSIG#	52410	1
XF3 range	160 - 400	36/36kA	XF3N400PE-LSIG#	67000	1
	250 - 630		XF3N630PE-LSIG#	70920	1
XF2 range	16 - 40	50/50kA	XF2H040PE-LSIG	43115	1
	25 - 63		XF2H063PE-LSIG	43115	1
	40 - 100		XF2H100PE-LSIG	43115	1
	63 - 160		XF2H160PE-LSIG	51930	1
	100 - 250		XF2H250PE-LSIG#	55965	1
XF3 range	160 - 400	50/50kA	XF3H400PE-LSIG#	71645	1
	250 - 630		XF3H630PE-LSIG#	76415	1

Note: Phase barriers are supplied along with all MCCBs.

Spreader terminals available as standard.

(For MCCB without spreader, please contact our nearest branch)

For accessories please refer page No.16 on Table1 & 2

With Microprocessor Release BMR & GMR - LSIG (3 & 4 Pole)

HSN Code : 8536

XB-BMR (LSIG)

- Conforms to IS/IEC 60947-2
- 40A to 1250A, 3P & 4P
- 36kA, 50kA breaking capacities
- I_{cs}=100% I_{cu}
- Adjustable overload setting from 0.4 to 1.0 x In
- Adjustable short-circuit setting from 1.5 to 8 x Ir
- Inbuilt instantaneous Protection
- Inbuilt ground fault protection from 20%-50% of In
- Adjustable neutral overload protection from 50% to 150% of Ir
- Switchable thermal memory
- Variable trip class
- Front LED Indication
- Panel mounted display for current metering & trip record
- Manual, Rotary and Motorised versions available@
- Wide range of accessories



XB-BMR :
I_{cu}/I_{cs} 36/36, 50/50 kA

XG1-GMR (LSIG)

- Conforms to IS/IEC 60947-2
- 16A to 160A, 3P & 4P
- 36kA & 50kA breaking capacities
- I_{cs}=100% I_{cu}
- Adjustable overload setting from 0.25 to 1.0 x In
- Adjustable short-circuit setting from 1.5 to 10 x Ir
- Adjustable instantaneous setting, 6 In & 12 In
- Inbuilt ground fault protection from 20%-70% of In
- Adjustable neutral overload protection from 50% to 200% of Ir
- Switchable thermal memory
- Provision for release testing
- Individual fault indication LEDs
- Transparent sealable release cover
- Compact size
- Wide range of accessories

Type	Release Range (A)	Breaking Capacity I _{cu} /I _{cs}	3 Pole		4 Pole		Std. Pkg.
			Cat. No.	MRP [₹]	Cat. No.	MRP [₹]	
XG1	10-40	36/36kA	XG1L040PE3-LSIG	40675	XG1L040PE4-LSIG	46530	1
	16-63		XG1L063PE3-LSIG	39915	XG1L063PE4-LSIG	45660	1
	25-100		XG1L100PE3-LSIG	39915	XG1L100PE4-LSIG	45660	1
	40-160		XG1N160PE3-LSIG	45880	XG1N160PE4-LSIG	57040	1
XB2	40-100	36/36kA	-	-	XB2V100PE4-LSIG	54975	1
	63-160		-	-	XB2N160PE4-LSIG	64890	1
	100-250		XB2N250PE3-LSIG	54975	XB2N250PE4-LSIG	68160	1
XB3	160-400	36/36kA	XB3N400PE3-LSIG	66350	XB3N400PE4-LSIG	76830	1
	250-630		XB3N630PE3-LSIG	71875	XB3N630PE4-LSIG	87880	1
XG1	10-40	50/50kA	XG1V040PE3-LSIG	45065	XG1V040PE4-LSIG	54310	1
	16-63		XG1V063PE3-LSIG	45065	XG1V063PE4-LSIG	54310	1
	25-100		XG1V100PE3-LSIG	45065	XG1V100PE4-LSIG	54310	1
	40-160		XG1H160PE3-LSIG	52515	XG1H160PE4-LSIG	61800	1
XB2	40-100	50/50kA	-	-	XB2L100PE4-LSIG	61965	1
	63-160		-	-	XB2H160PE4-LSIG	68840	1
	100-250		XB2H250PE3-LSIG	58695	XB2H250PE4-LSIG	71990	1
XB3	160-400	50/50kA	XB3H400PE3-LSIG	70300	XB3H400PE4-LSIG	82360	1
	250-630		XB3H630PE3-LSIG	76380	XB3H630PE4-LSIG	98460	1
XB4	320-800	50/50kA	XB4H800PE3-LSIG	122460	XB4H800PE4-LSIG	146805	1
	400-1000		XB4H1000PE3-LSIG	150390	XB4H1000PE4-LSIG	211120	1
	500-1250		XB4H1250PE3-LSIG	184760	XB4H1250PE4-LSIG	239070	1

@ Motorized version available for XB2 and XB3 Frames

For accessories please refer page No.16 on Table3, 4 & 5

General Information

- Use of phase barriers is mandatory. These are supplied along with MCCBs
- It is recommended to use spreader terminals for enhancing termination capacity
- Spreader terminals are available as accessories, unless otherwise specified against cat. nos.

MCCB for Motor back-up protection



HSN Code : 8536



- **XF1, XF2 & XF3 Frame**
- Conforms to IS/IEC 60947-2
- Range: 32A - 630A
- $I_{cu}/I_{cs} = 50/50kA$
- High Performance Compact Size
- Suitability for Isolation
- Rated at 50°C
- Line Load Interchangeability
- Double Insulation
- Magnetic Trip unit

Type	Release Range (A)	Breaking Capacity I_{cu}/I_{cs} at 415V AC	3 Pole		Std. Pkg.
			Cat. No.	MRP [₹]	
XF1 range	32	50/50kA	XFV032P-MO	7805	1
	40		XFV040P-MO	7805	1
	50		XFV050P-MO	7805	1
	63		XFV063P-MO	7805	1
	80		XFV080P-MO#	7805	1
	100		XFV100P-MO#	9940	1
XF2 range	125	50/50kA	XF2H125P-MO	13250	1
	160		XF2H160P-MO	20245	1
	200		XF2H200P-MO#	23940	1
	250		XF2H250P-MO#	27905	1
XF3 range	320	50/50kA	XF3H320P-MO#	34800	1
	400		XF3H400P-MO#	34800	1
	500		XF3H500P-MO#	39950	1
	630		XF3H630P-MO#	46060	1

Note: Phase barriers are supplied along with all MCCBs.

#Spreader terminals available as standard.

(For MCCB without spreader, please contact our nearest branch)

For accessories please refer page No.16 on Table1 & 2

Accessories - XF Range MCCBs:



Shunt Release

UV Release

ATAC

Table 1 HSN Code : 8538

Description	Internal		
	Cat. No.	MRP [₹]	Std. Pkg.
Auxiliary + Trip Alarm Contact			
1 C/O + 1C/O (F1, F2 & F3)	XFALAX11	2135	1
2 C/O (F1, F2 & F3)	XFAX2	2100	1
Shunt Release			
220V - 415V F1	XFSHT220V	1840	1
220V - 415V F2	XF2SHT220V	1875	1
220V - 415V F3	XF3SHT220V	3040	1
Under Voltage Release			
240V F1	XFUV240VA	2405	1
240V F2	XF2UV240VA	2430	1
240V F3	XF3UV240VA	3800	1
415V F1	XFUV415VA	2765	1
415V F2	XF2UV415VA	2795	1
415V F3	XF3UV415VA	3800	1

Table 2 HSN Code : 8538

Description	External		
	Cat. No.	MRP [₹]	Std. Pkg.
Spreader Terminals	ACMF1TP100	525	Set of 6
	ACMF2TP160-T	2070	Set of 6
	ACMF2TP250	2070	Set of 6
Extended Rotary Handle	XF1ROHE	2620	1
	XF2ROHE/XF2ROHE-LSIG	2800	1
Direct Rotary Handle	XF3ROHE	5400	1
	XF1ROHD	1655	1
Din Rail	XF2ROHD	1720	1
	F1DIN	320	1
Phase Barriers	F1PB	150	Set of 4
	F2PB	340	Set of 4
	F3PB	350	Set of 4
MCCB Enclosure	F1EU3P	1395	1
	F2EU3P	3020	1

Table 3 HSN Code : 8538

Description	External		
	Cat. No.	MRP [₹]	Std. Pkg.
Rotary Handle			
XA1, XB0 Direct ROM	XB0A1ROHD	1630	1
XA2, XB1 Direct ROM	XB1A2ROHD	1670	1
XG1 Direct ROM	XG1ROHD	1700	1
XB2 Direct ROM	XB2ROHD	1725	1
XA3, XB3S, XB3 Direct ROM	XB3A3ROHD	2575	1
XA1, XB0 Extended ROM	XB0A1ROHE	2110	1
XA2, XB1 Extended ROM	XB1A2ROHE	2155	1
XG1 Extended ROM	XG1ROHE	2300	1
XB2 Extended ROM	XB2ROHE	2595	1
XA3, XB3S, XB3 Extended ROM	XB3A3ROHE	4230	1
XB4 Extended ROM	XB4ROHE	5375	1
Stored Energy Electrical Operating Mechanism			
XB2 - 240V AC*		37145	
XB3 - 240V AC*		46545	

Accessories - XB/XG1 Range MCCBs:



Auxiliary Contact

ATAC

Shunt Release

UV Release

Table 4 HSN Code : 8538

Description	Internal		
	Cat. No.	MRP [₹]	Std. Pkg.
Auxiliary Contact			
XA1, XA2, XB0, XB1 - 1 C/O - Right	XB01A12AUX1	1220	1
XA1, XA2, XB0, XB1 - 2 C/O - Right	XB01A12AUX2	2165	1
XG1 - 1 C/O	XG1AUX1	1220	1
XA3, XB2, XB3S, XB3, XB4 - 1 C/O	XB234A3AUX1	1420	1
XA3, XB2, XB3S, XB3, XB4 - 2 C/O	XB234A3AUX2	2740	1
Trip Alarm Contact			
XA1, XA2, XB0, XB1 - 1 C/O - Right	XB01A12ALR1	1220	1
XG1 - 1 C/O	XG1AUX1	1220	1
XA3, XB2, XB3S, XB3, XB4 - 1 C/O - Right	XB234ALR1	1490	1
Auxiliary 1 C/O + TAC 1 C/O			
XA1, XA2, XB0, XB1 - Right	XB01A12ALAX1	2085	1
XA3, XB2, XB3S, XB3, XB4 - Right	XB234ALAX1	2740	1
Shunt Release			
XA1, XA2, XB0, XB1 - 24V DC - Left	XB01A12SHT24V	2520	1
XA1, XA2, XB0, XB1 - 240/415V AC - Left	XB01A12SHTUNI	2420	1
XG1 - 240V AC	XG1SHT240V	3235	1
XA3, XB2, XB3S, XB3, XB4 - ^{110/240/415V AC,} _{110/220V DC}	XB234A3SHTUNI	3560	1
Under Voltage Release			
XA1, XA2, XB0, XB1 - 240V AC - Left	XB01A12UV240V	4010	1
XG1 - 240V AC	XG1UV240V	4065	1
XA3, XB2, XB3S, XB3 - 240V AC - Left	XB23UV240V	4945	1
XB4 - 240V AC - Left	XB4UV240V	5640	1

** Use these catcode of UV with they look MCCBs only

Table 5 HSN Code : 8538

Description	External		
	Cat. No.	MRP [₹]	Std. Pkg.
Spreader Terminals - 3 Pole			
XA1, XB0-100 - 3 Pole	XB0A1100TPST	485	Set of 6
XA1, XB0-125D - 3 Pole	XB0A1125TPST	670	Set of 6
XG1 - 160 - 3 Pole	XG160TPST	1985	Set of 6
XA2, XB1, XB2 - 250 - 3 Pole	XB12A2250TPST	2075	Set of 6
XA3, XB3S/XB3-400 - 3 Pole	XB3400TPST	4075	Set of 6
XB3-630 - 3 Pole	XB3630TPST	4725	Set of 6
XB4-800 - 3 Pole	XB4800TPST	9955	Set of 6
XB4-1000 - 3 Pole	XB41000TPST	19920	Set of 12
XB4-1250 - 3 Pole	XB41250TPST	39325	Set of 6
Spreader Terminals - 4 Pole			
XA1, XB0-100 - 4 Pole	XB0A1100FPST	760	Set of 8
XA1, XB0-125D - 4 Pole	XB0A1125FPST	955	Set of 8
XG1 - 160 - 4 Pole	XG160FPST	2595	Set of 8
XA2, XB1, XB2 - 250 - 4 Pole	XB12A2250FPST	2740	Set of 8
XA3, XB3S/XB3-400 - 4 Pole	XB3400FPST	5860	Set of 8
XB3-630 - 4 Pole	XB3630FPST	5995	Set of 8
XB4-800 - 4 Pole	XB4800FPST	12725	Set of 8
XB4-1000 - 4 Pole	XB41000FPST	25345	Set of 16
XB4-1250 - 4 Pole	XB41250FPST	50380	Set of 8

Note: Phase barriers are supplied along with MCCBs

* Available as customised factory fitted solutions, please contact nearest sales office

X-Line TPN S-D-F suitable for DIN fuse-link (TPN & FP) in open execution

- Range 32A to 800A, 415V, AC 23A
- Conforms to IS/IEC 60947-3
- Terminal Shrouds on both sides and Phase Barriers included
- Telescopic shaft for depth adjustment
- TPN SDF has isolable neutral
- 4P SDF has Switched Neutral Pole and is 100% rated
- Door interlock & padlock facility



HSN Code : 8537

Size	Rated Current (A)	Suitable Fuse link for reference		Open Execution type TPN SDF - Suitable for DIN Fuse - link				Open Execution type FP SDF - Suitable for DIN Fuse - link			
		Type	Range (A)	Type	Cat No.	MRP [₹]	Std. Pkg (Nos.)	Type	Cat No.	MRP [₹]	Std. Pkg (Nos.)
Frame 1	32	HF Size 14x51	2 to 32	32 TPN / FP	BXL95518	3140	1	32 TPN / FP	BXL95518	3140	1
	32	HF Size 14x51	2 to 32	32 TPN / FP CE*	BXL95703*	2720	1	32 TPN / FP CE*	BXL95703	2720	1
	63	HF Size 14x51	2 to 63	63 TPN / FP	BXL95421	4130	1	63 TPN / FP	BXL95421	4130	1
	63	HF Size 14x51	2 to 63	63 TPN / FP CE*	BXL95704*	3685	1	63 TPN / FP CE*	BXL95704	3685	1
Frame 2	100	Size 000/00	63 to 100	100 TPN	BXL95568	7685	1	100 FP	BXL90496	8980	1
	125	Size 000/00	63 to 125	125 TPN	BXL95001	9960	1	125 FP	BXL90497	11175	1
	160	Size 000/00	63 to 160	160 TPN	BXL95713	10710	1	160 FP	BXL90498	12525	1
Frame 3	200	Size 0	80 to 200	200 TPN	BXL95418	14460	1	200 FP	BXL90471	17890	1
	250	Size 1	125 to 250	250 TPN	BXL95642	16830	1	250 FP	BXL90472	20270	1
Frame 4	315	Size 1	125 to 315	315 TPN	BXL95461	20155	1	315 FP	BXL90473	24595	1
	400	Size 2	200 to 400	400 TPN	BXL95481	24595	1	400 FP	BXL90480	27890	1
Frame 5	630	Size 3	315 to 630	630 TPN	BXL95521	41140	1	630 FP	BXL90481	47030	1
	800	Size 3	315 to 800	800 TPN	BXL95679	44270	1	800 FP	BXL90482	53435	1

* 'CE' handle has door interlock facility without defeat feature

Note: Add a suffix "OOOO" for all the above mentioned catcodes

X - Line TPN SDF in SS Enclosure

- Range 32A to 800A, 415V, AC 23A
- Spacious Sheet Steel Enclosure
- Separate cable gland box not required
- Terminal Shrouds on both sides and Phase Barriers included
- Conforms to IS/IEC 60947-3
- Suitable for Cylindrical/DIN fuse-link
- Door interlock & padlock facility



HSN Code : 8537

Size	Rated Current (A)	Suitable Fuse link for reference		In sheet steel Enclosure Type TPN SDF Suitable for DIN Fuse -link			
		Type	Range (A)	Type	Cat No.	MRP (₹)	Std. Pkg (Nos.)
Frame 1	32	HF Size 14x51	2 to 32	32 TPN / FP CE*	BXLENC90483*	7375	1
	63	HF Size 14x51	2 to 63	63 TPN / FP CE*	BXLENC90484*	8805	1
Frame 2	100	Size 000/00	63 to 100	100 TPN	BXLENC90485	14195	1
	125	Size 000/00	63 to 125	125 TPN	BXLENC90486	16100	1
	160	Size 000/00	63 to 160	160 TPN	BXLENC90487	16870	1
Frame 3	200	Size 0	80 to 200	200 TPN	BXLENC90488	24370	1
	250	Size 1	125 to 250	250 TPN	BXLENC90489	26850	1
Frame 4	315	Size 1	125 to 315	315 TPN	BXLENC90490	31180	1
	400	Size 2	200 to 400	400 TPN	BXLENC90491	35700	1
Frame 5	630	Size 3	315 to 630	630 TPN	BXLENC90492	54650	1
	800	Size 3	315 to 800	800 TPN	BXLENC90493	58060	1

* 'CE' handle has door interlock facility without defeat feature

Note: Add a suffix "OOOO" for all the above mentioned catcodes

- Range 32A to 630A, 415V, AC 23A
- Conforms to IS/IEC 60947-3
- Terminal Shrouds on both sides and Phase Barriers included
- Telescopic shaft for depth adjustment
- Door interlock & padlock facility
- Also for 220V DC & 240V AC applu on

HSN Code : 8537

Size	Rated Current (A)	Suitable Fuse link for reference	2P SDF Suitable for DIN Fuse link - Open Execution			
			Type	Cat No.	MRP [₹]	Std. Pkg (Nos.)
Frame 1	32	HF Size 14x51	32 2P	BXL95594	2460	1
	63	HF Size 14x51	63 2P	BXL95595	3430	1
Frame 2	100	Size 000/00	100 2P	BXL35086	6025	1
	125	Size 000/00	125 2P	BXL35087	8610	1
Frame 3	160	Size 000/00	160 2P	BXL35088	8970	1
	200	Size 0	200 2P	BXL35089	11350	1
Frame 4	250	Size 1	250 2P	BXL31674	13575	1
	315	Size 1	315 2P	BXL38930	16810	1
Frame 5	400	Size 2	400 2P	BXL31676	18930	1
	630	Size 3	630 2P	BXL35090	31715	1



2 Pole - Din Type Fuse link

Note: Add a suffix "OOOO" for all the above mentioned catcodes

X-Line SDF suitable for BS fuse-link (TPN) in open execution

- Range 32A to 630A, 415V, AC 23A
- Conforms to IS/IEC 60947-3
- Terminal Shrouds on both sides and Phase Barriers included
- Telescopic shaft for depth adjustment
- Door interlock & padlock facility

HSN Code : 8537

Size	Rated Current (A)	Suitable Fuse link for reference	TPN SDF Suitable for BOLTED Fuse link - Open Execution			
			Type	Cat No.	MRP [₹]	Std. Pkg (Nos.)
Frame 1	32	A1L	32 TPN	BXL95653	2915	1
	63	A1L	63 TPN	BXL95651	3935	1
Frame 2	100	A4	100 TPN	BXL95570	7540	1
	125	A4	125 TPN	BXL95009	9835	1
Frame 3	160	A4	160 TPN	BXL95714	10260	1
	200	B1 / B2	200 TPN	BXL95588	13965	1
Frame 4	250	B2 / B3	250 TPN	BXL95682	16810	1
	315	B3	315 TPN	BXL95590	20145	1
Frame 5	400	B4	400 TPN	BXL95591	24155	1
	630	C2	630 TPN	BXL95592	40725	1



TPN Bolted Type Fuse link

Note: Add a suffix "OOOO" for all the above mentioned catcodes

X-Line SDF - Spares & Accessories

HSN Code : 8538

Description		Type	Cat No.	MRP [₹]	Std. Pkg (Nos.)				
	Auxiliary Contact Kit (1NO + 1 NC)	32/63	BXL91302	660	1				
		100/125/160	BXL91328	800	1				
		200/250	BXL91329	1080	1				
		315/400/630/800	BXL91330	1145	1				
	2nd Aux. Contact (1NO + 1NC)	32/63	BXL90670	725	1				
		100 to 1000	BXL90696	840	1				
	Earthing Link	32 to 1000@	BXL90396	650	1				
		Terminal Shroud Kit	32/63	BXL91190	230	1			
			100/125/160	BXL91137	285	1			
			200/250	BXL91335	810	1			
			315/400	BXL91346	830	1			
			630/800	BXL91347	880	1			
	Handle Assembly - A	32/63	BXL91257	640	1				
		100 to 250	BXL91258	1355	1				
		315/400/630/800	BXL91259	1490	1				
	Handle Assembly - B	32/63	BXL91277	640	1				
		100 to 250	BXL91278	1355	1				
	Handle Assembly - CE	315/400/630/800	BXL91279	1490	1				
Interphase Barrier Kit		32/63	BXL91337	380	1				
		200	BXL91343	580	1				
		315/400	BXL91344	600	1				
	Castell Type Lock	A	100/125/160/200/250	BXL00333	3160	1			
				BXL00334	3160	1			
				BXL00335	3160	1			
				BXL00336	3160	1			
		B	315/400/630/800	BXL00345	3160	1			
				BXL00346	3160	1			
				BXL00347	3160	1			
				BXL00348	3160	1			
				Switched Neutral Kit		100/125/160	BXL95233	6005	1
						200/250	BXL95516	6405	1
		315/400	BXL95517	6920	1				
		630/800	BXL95546	9715	1				

@For terminating earth busbar upto 25mm width. Order Qty 1 for 10 earthing links
Note: Add a suffix "OOOO" for all the above mentioned catcodes

Switch Disconnecter Fuse Units

Suitable for DIN / BOLTED fuses in open execution

Rating (A) AC-23A	Cat No.	Fuse Type	Type	MRP [₹]
32A	PSFS323ND00	DIN	TPN	2895
32A	PSFS323ND000	DIN	TPN	2895
32A	PSFS323NB	Bolted	TPN	2895
32A	PSFS323B	Bolted	TP	3010
63A	PSFS633ND00	DIN	TPN	4120
63A	PSFS633ND000	DIN	TPN	4120
63A	PSFS633NB	Bolted	TPN	4005
63A	PSFS633B	Bolted	TP	4120
100	PSFS1003*	DIN/Bolted	TP	9135
100	PSFS1003N*	DIN/Bolted	TPN	9135
125	PSFS1253*	DIN/Bolted	TP	12350
125	PSFS1253N*	DIN/Bolted	TPN	12350
160	PSFS1603*	DIN/Bolted	TP	12665
160	PSFS1603N*	DIN/Bolted	TPN	13750
200	PSFS2003B	Bolted	TP	14275
200	PSFS2003NB	Bolted	TPN	14730

* Use suffix 'D' for DIN type, 'B' for bolted type

Switch Disconnecter

HSN Code : 8536

Rating (A) AC-23A	Cat No.	Fuse Type	Type	MRP [₹]
32A	PSSD323N	-	TPN	2715
63A	PSSD633N	-	TPN	3720
100A	PSSD1003N	-	TPN	8475
125A	PSSD1253N	-	TPN	10525
160A	PSSD1603N	-	TPN	11865
200A	PSSD2003N	-	TPN	12410

Fuse Switch Units Type FS

HSN Code : 8538

Rating (A) AC-23A	Cat No.	Fuse Type	Type	MRP [₹]
32A	FS0N	BOLTED	TP	3805
63A	FS1N	BOLTED	TP	5110
Shroud	AC21TS			275
1NO+1NC	AC21EB11	for FS0 / FS1N		930
Neutral	AC21L	for FS0 / FS1N-		400
Handle assembly-32A	SP21FS0H	for FS0		555
Handle assembly-63A	SP21FS1H	for FS1		555

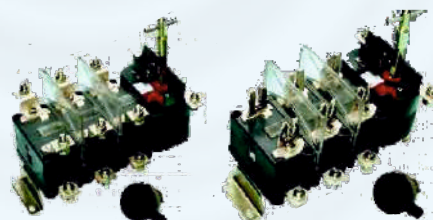

Switch Disconnecter Fuse

- Conforms to IS 13947-3
- TPN/TP version
- AC 23A duty
- Mechanism with 4 Breaks per pole
- Handle with door interlock and padlock



Polycarbonate Plug & Socket BPX Series=



BPX Range of Plugs/Socket/Connector- 16A to 125A:

Conform to International standards EN/IEC 60309-1 & 2

HSN Code : 8536

HSN Code : 8536

Panel Mounted Straight Socket - IP44						
	Amp	Poles	230V~ 50-60Hz	415V~ 50-60Hz	Lot size	MRP (₹) / Unit
	16	3	BPX1PSS341		10	725
		4		BPX1PSS442	10	1160
		5		BPX1PSS542	10	1175
	32	3	BPX2PSS341		10	1250
		4		BPX2PSS442	10	1425
		5		BPX2PSS542	10	1440
	63	3	BPX3PSS341		5	4960
		4		BPX3PSS442	5	5070
		5		BPX3PSS542	5	5105

Panel Mounted Straight Socket - IP67						
	Amp	Poles	230V~ 50-60Hz	415V~ 50-60Hz	Lot size	MRP (₹) / Unit
	16	3	BPX1PSS371		10	1505
		4		BPX1PSS472	10	1635
		5		BPX1PSS572	10	1645
	32	3	BPX2PSS371		10	1880
		4		BPX2PSS472	10	2145
		5		BPX2PSS572	10	2165
	63	3	BPX3PSS371		5	5555
		4		BPX3PSS472	5	5575
		5		BPX3PSS572	5	5600
125	3	BPX4PSS371		2	18940	
	4		BPX4PSS472	2	19030	
	5		BPX4PSS572	2	19140	

Panel Mounted Angled Socket - IP44						
	Amp	Poles	230V~ 50-60Hz	415V~ 50-60Hz	Lot size	MRP (₹) / Unit
	16	3	BPX1PAS341		10	725
		4		BPX1PAS442	10	1170
		5		BPX1PAS542	10	1185
	32	3	BPX2PAS341		10	1250
		4		BPX2PAS442	10	1445
		5		BPX2PAS542	10	1460
	63	3	BPX3PAS341		5	4960
		4		BPX3PAS442	5	5105
		5		BPX3PAS542	5	5130

Panel Mounted Angled Socket - IP67						
	Amp	Poles	230V~ 50-60Hz	415V~ 50-60Hz	Lot size	MRP (₹) / Unit
	16	3	BPX1PAS371		10	1505
		4		BPX1PAS472	10	1635
		5		BPX1PAS572	10	1650
	32	3	BPX2PAS371		10	1880
		4		BPX2PAS472	10	2145
		5		BPX2PAS572	10	2160
	63	3	BPX3PAS371		5	5555
		4		BPX3PAS472	5	5575
		5		BPX3PAS572	5	5600
125	3	BPX4PAS371		2	18940	
	4		BPX4PAS472	2	19030	
	5		BPX4PAS572	2	19140	

Surface Mounted Socket - IP44						
	Amp	Poles	230V~ 50-60Hz	415V~ 50-60Hz	Lot size	MRP (₹) / Unit
	16	3	BPX1WS341		10	1160
		4		BPX1WS442	10	1280
		5		BPX1WS542	10	1295
	32	3	BPX2WS341		10	1445
		4		BPX2WS442	10	1575
		5		BPX2WS542	10	1595
	63	3	BPX3WS341		3	5675
		4		BPX3WS442	3	5685
		5		BPX3WS542	3	5710

Surface Mounted Socket - IP67						
	Amp	Poles	230V~ 50-60Hz	415V~ 50-60Hz	Lot size	MRP (₹) / Unit
	16	3	BPX1WS371		10	1960
		4		BPX1WS472	10	2480
		5		BPX1WS572	10	2500
	32	3	BPX2WS371		10	2430
		4		BPX2WS472	10	2995
		5		BPX2WS572	10	3020
	63	3	BPX3WS371		3	7130
		4		BPX3WS472	3	7160
		5		BPX3WS572	3	7210
125	3	BPX4WS371		1	23285	
	4		BPX4WS472	1	25545	
	5		BPX4WS572	1	25655	

Standard Connector - IP44						
	Amp	Poles	230V~ 50-60Hz	415V~ 50-60Hz	Lot size	MRP (₹) / Unit
	16	3	BPX1SC341		10	900
		4		BPX1SC442	10	1060
		5		BPX1SC542	10	1070
	32	3	BPX2SC341		10	1160
		4		BPX2SC442	10	1455
		5		BPX2SC542	10	1465
	63	3	BPX3SC341		5	6085
		4		BPX3SC442	5	6100
		5		BPX3SC542	5	6125

Standard Connector - IP67						
	Amp	Poles	230V~ 50-60Hz	415V~ 50-60Hz	Lot size	MRP (₹) / Unit
	16	3	BPX1SC371		10	1895
		4		BPX1SC472	10	2255
		5		BPX1SC572	10	2275
	32	3	BPX2SC371		10	2615
		4		BPX2SC472	10	2935
		5		BPX2SC572	10	2950
	63	3	BPX3SC371		5	6190
		4		BPX3SC472	5	6210
		5		BPX3SC572	5	6235
125	3	BPX4SC371		1	19865	
	4		BPX4SC472	1	20255	
	5		BPX4SC572	1	20365	

Polycarbonate Plug & Socket BPX Series=





BPX Range of Plugs/Socket/Connector- 16A to 125A:

Conform to International standards EN/IEC 60309-1 & 2

HSN Code : 8536

HSN Code : 8536

Standard Plug - IP44						
	Amp	Poles	230V~	415V~	Lot size	MRP (₹) / Unit
			50-60Hz	50-60Hz		
	16	3	BPX1SP341		10	595
		4		BPX1SP442	10	830
		5		BPX1SP542	10	840
	32	3	BPX2SP341		10	1005
		4		BPX2SP442	10	1220
		5		BPX2SP542	10	1230
	63	3	BPX3SP341		5	4730
		4		BPX3SP442	5	4760
		5		BPX3SP542	5	4790

Standard Plug - IP67						
	Amp	Poles	230V~	415V~	Lot size	MRP (₹) / Unit
			50-60Hz	50-60Hz		
	16	3	BPX1SP371		10	1315
		4		BPX1SP472	10	1775
		5		BPX1SP572	10	1790
	32	3	BPX2SP371		10	2020
		4		BPX2SP472	10	2145
		5		BPX2SP572	10	2175
	63	3	BPX3SP371		5	5435
		4		BPX3SP472	5	5465
		5		BPX3SP572	5	5490
125A		3	BPX4SP371		1	17085
		4		BPX4SP472	1	17120
		5		BPX4SP572	1	17230

Phase Inverter Plug - IP44					
	Amp	Poles	415V~	Lot size	MRP (₹) / Unit
			50-60Hz		
	16	5	BPX1PIP542	10	1390
	32	5	BPX2PIP542	10	1965

Phase Inverter Plug - IP67					
	Amp	Poles	415V~	Lot size	MRP (₹) / Unit
			50-60Hz		
	16	5	BPX1PIP572	10	2765
	32	5	BPX2PIP572	10	3285

Panel Mounted Plug - IP44						
	Amp	Poles	230V~	415V~	Lot size	MRP (₹) / Unit
			50-60Hz	50-60Hz		
	16	3	BPX1PP341		10	940
		4		BPX1PP442	10	1285
		5		BPX1PP542	10	1320
	32	3	BPX2PP341		10	1360
		4		BPX2PP442	10	1590
		5		BPX2PP542	10	1625
	63	3	BPX3PP341		5	4950
		4		BPX3PP442	5	4990
		5		BPX3PP542	5	5065

Panel Mounted Plug - IP67						
	Amp	Poles	230V~	415V~	Lot size	MRP (₹) / Unit
			50-60Hz	50-60Hz		
	16	3	BPX1PP371		10	1990
		4		BPX1PP472	10	2640
		5		BPX1PP572	10	2685
	32	3	BPX2PP371		10	2570
		4		BPX2PP472	10	2760
		5		BPX2PP572	10	2810
	63	3	BPX3PP371		5	5500
		4		BPX3PP472	5	5535
		5		BPX3PP572	5	5555
125A		3	BPX4PP371		2	18490
		4		BPX4PP472	2	19740
		5		BPX4PP572	2	20020

Surface Mounted Plug - IP44						
	Amp	Poles	230V~	415V~	Lot size	MRP (₹) / Unit
			50-60Hz	50-60Hz		
	16	3	BPX1WP341		10	1745
		4		BPX1WP442	8	2340
		5		BPX1WP542	10	2370
	32	3	BPX2WP341		10	2885
		4		BPX2WP442	10	3350
		5		BPX2WP542	10	3410
	63	3	BPX3WP341		2	6640
		4		BPX3WP442	2	6690
		5		BPX3WP542	2	6790

Surface Mounted Plug - IP67						
	Amp	Poles	230V~	415V~	Lot size	MRP (₹) / Unit
			50-60Hz	50-60Hz		
	16	3	BPX1WP371		10	2465
		4		BPX1WP472	8	3165
		5		BPX1WP572	10	3215
	32	3	BPX2WP371		10	5505
		4		BPX2WP472	10	5655
		5		BPX2WP572	10	5745
	63	3	BPX3WP371		2	7455
		4		BPX3WP472	2	7490
		5		BPX3WP572	2	7600

Polycarbonate Plug & Socket BPX Series=



BPX Range of Socket Outlet with Switch and Mechanical Interlock

Conform to International standards EN/IEC 60309-1 & 2

HSN Code : 8536

Socket Outlet with Switch and Mechanical Interlock

Horizontal Type - IP44

	Amp	Poles	230V~ 50-60Hz	415V~ 50-60Hz	Lot size	MRP (₹) / Unit
	16	3		BPX1MIH341		4
4				BPX1MIH442	4	11750
5				BPX1MIH542	4	11805

Horizontal Type - IP67

	Amp	Poles	230V~ 50-60Hz	415V~ 50-60Hz	Lot size	MRP (₹) / Unit
	16	3		BPX1MIH371		4
4				BPX1MIH472	4	11965
5				BPX1MIH572	4	12005

Vertical Type - IP44

	Amp	Poles	230V~ 50-60Hz	415V~ 50-60Hz	Lot size	MRP (₹) / Unit
	16	3		BPX1MIV341		1
4				BPX1MIV442	1	14330
5				BPX1MIV542	1	14380
32	3		BPX2MIV341		1	13365
	4			BPX2MIV442	1	16260
	5			BPX2MIV542	1	16315
63	3		BPX3MIV341		1	29115
	4			BPX3MIV442	1	30450
	5			BPX3MIV542	1	30500
-						

Vertical Type - IP67

	Amp	Poles	230V~ 50-60Hz	415V~ 50-60Hz	Lot size	MRP (₹) / Unit
	16	3		BPX1MIV371		1
4				BPX1MIV472	1	14545
5				BPX1MIV572	1	14600
32	3		BPX2MIV371		1	13585
	4			BPX2MIV472	1	16475
	5			BPX2MIV572	1	16530
63	3		BPX3MIV371		1	29385
	4			BPX3MIV472	1	30715
	5			BPX3MIV572	1	30775
125	3		BPX4MIV371		1	96950
	4			BPX4MIV472	1	105665
	5			BPX4MIV572	1	105720

HSN Code : 8536

Socket Outlet with Duo Interlock and DIN Rail

Vertical Type - IP44

	Amp	Poles	230V~ 50-60Hz	415V~ 50-60Hz	Lot size	MRP (₹) / Unit
	16	3		BPX1MID341		1
4				BPX1MID442	1	16535
5				BPX1MID542	1	17085
32	3		BPX2MID341		1	13235
	4			BPX2MID442	1	19025
	5			BPX2MID542	1	19035
63	3		BPX3MID341		1	26960
	4			BPX3MID442	1	29465
	5			BPX3MID542	1	31250
-						

Vertical Type - IP67

	Amp	Poles	230V~ 50-60Hz	415V~ 50-60Hz	Lot size	MRP (₹) / Unit
	16	3		BPX1MID371		1
4				BPX1MID472	1	16860
5				BPX1MID572	1	17410
32	3		BPX2MID371		1	13470
	4			BPX2MID472	1	19255
	5			BPX2MID572	1	19310
63	3		BPX3MID371		1	27245
	4			BPX3MID472	1	29790
	5			BPX3MID572	1	31530
125	3		BPX4MID371		1	100495
	4			BPX4MID472	1	108440
	5			BPX4MID572	1	108485



Metal Clad - Plugs & Sockets Type 'MP' & 'MS'

HSN Code : 8536

Rating	Pins	Type	Cat No.	MRP [₹]
20A, 250V	2P + E	Plug	MP20	335
		Socket	MS20	375
30A, 440V	3P + E	Plug	MP30	770
		Socket	MS30	810



Plastic Plugs & Socket Type 'PS'

HSN Code : 8536

Rating	Pins	Type	Cat No.	MRP [₹]
20A, 250V	3	Plug	PS16AA7	370
		Flush Mounting Socket	PS16BA7	515
		Socket with Wall Mounting Box	PS16DA7	640
20A, 415V	4	Plug	PS16AA1	450
		Flush Mounting Socket	PS16BA1	675
		Socket with Wall Mounting Box	PS16DA1	790
32A, 415V	3	Plug	PS32AA7	775
		Socket	PS32BA7	775
	4	Plug	PS32AA1	810
		Socket	PS32BA1	810
	5	Plug	PS32AA5	865
		Socket	PS32BA5	865

- Self Locking design : Extremely safe
- Plug cannot be pulled out in fully engaged position
- Auto closing socket shutter
- Reliable Earthing
- Shrouded Terminals for safety

Heavy duty Metal-Control 'SS'



Heavy Duty Metal - Control Plugs & Sockets Type 'SS'

HSN Code : 8536

Rating	Pins	Type	Cat No.	MRP [₹]
12A, 415V (Control)	12	Panel Mounting Socket	2499/12	2780
		Plug with inclined Handle	299/12B	2005

Heavy duty Metal-Power 'SS'



Heavy Duty Metal - Power Plugs & Sockets Type 'SS'

HSN Code : 8536

Rating	Pins	Type	Cat No.	MRP [₹]
30A, 415V	3	Panel Mounting Socket	2415B	1110
		Plug with inclined Handle	215B	1090
30A, 415V	4	Panel Mounting Socket	2413B	1160
		Plug with inclined Handle	213B	1135
30A, 415V	5	Panel Mounting Socket	2417B	1215
		Plug with inclined Handle	217B	1180

Note : *Loose Conduit Box Straight (Cat. No. 9J101) MRP - Rs. 460/- each
 *Spare Handle Inclined (Cat. No. 9J108) MRP -Rs. 220/- each.

HSN Code : 8536

Heavy Duty Metal Plug & Sockets Type 'DS' - 5 Pin (with Integral Switching Device)

HSN Code : 8536

Rating	Pins	Type	Cat No.	MRP[₹]
16A, 415V	5	Plug	DS1A7A1	1800
		Socket	DS1B7A1	2230
		Handle Assembly	SP91PH	355
32A, 415V	5	Plug	DS3A7A1	2940
		Socket	DS3B7A1	3570
		Handle Assembly	SP93PH	370
63A, 415V	5	Plug	DS6A7A1	4680
		Socket	DS6B7A1	6450
		Handle Assembly	SP96PH	510
125A, 415V	5	Plug	DS9A7A1	13475
		Socket	DS9B7A1	19260
		Handle Assembly	SP99PH	1255

Note : Power Receptacles with or without SFU/SDFU/MCB/MCCB having loop-in / loop-out facility is available on request.



- Range from 16A to 125 A
- 5 Pin configuration (3P+N+E)
- Plug cannot come out in ON condition (Integral Interlocking)

- Spring loaded Butt type contacts
- Self aligning and self wiping

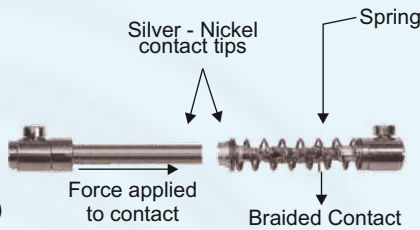

Quick Disconnect

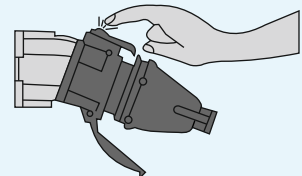

*Sparkless
Butt type contact*

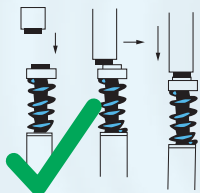

- Self aligning self wiping
- Spring loaded for consistent pressure
- Silver nickle material for extremely low temperature rise

Safety Disk



Vibration proof termination

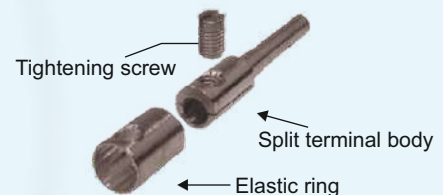

Metal Clad - Plug & Socket Box Type 'MPSEU'

HSN Code : 8536

Rating	Pins	Mounting	Type	Cat No.	MRP [₹]
20A, 250V	2P + E	Universal	Plug & Socket Box - SP-MCB Cutout	MPSEU201	1480
20A, 250V	2P + E	Universal	Plug & Socket Box - DP-MCB Cutout	MPSEU202	1480
30A, 415V	3P + E	Universal	Plug & Socket Box - TPN-MCB Cutout	MPSEU301	3710



20A

20A

30A

Plastic - Plug & Socket Box Type 'PSEU / PSEF'

HSN Code : 8536



Rating	Pins	Mounting	Type	Cat No.	MRP [₹]
20A, 250V	3	Universal	Plug & Socket Box with SP MCB Cutout	PSEU201	1780
			Plug & Socket Box with DP-MCB Cutout	PSEU202	1825
		Flush	Plug & Socket Box with SP MCB Cutout	PSEF201	1780
			Plug & Socket Box with DP-MCB Cutout	PSEF202	1825
32A, 415V	4	Universal	Plug & Socket Box with 4P MCB Cutout	PSEU324	3850
			5	PSEU325	3925
	4	Flush	Plug & Socket Box with 4P MCB Cutout	PSEF324	3850
			5	PSEF325	3925

Heavy Duty Metal - Plug & Socket Box Type 'SSEU'

HSN Code : 8536

Rating	Pins	Mounting	Type	Cat No.	MRP [₹]
30A, 415V	3	Universal	Plug & Socket Box with SP MCB Cutout	SSEU303-MCB1P	4350
	3	Universal	Plug & Socket Box with DP MCB Cutout	SSEU303	4350
	4	Universal	Plug & Socket Box with 4P MCB Cutout	SSEU304	4460
				SSEU305	4560

Stainless Steel Cover Plug & Socket Box Type 'PSEU-SSC'/SSEU-SSC'

HSN Code : 8536



Rating	Pins	Mounting	Type	Cat No.	MRP [₹]
20A, 250V 32A, 415V	3	Universal	P&S Box with 'PS' P&S and SP MCB Cutout	PSEU201-SSC	2225
	5		P&S Box with 'PS' P&S and 4P MCB Cutout	PSEU325-SSC	4495
30A, 415V	3	Universal	Plug & Socket Box with SP MCB Cutout	SSEU303-SSC-MCB1P	4995
			Plug & Socket Box with DP MCB Cutout	SSEU303-SSC	4995
	4	Universal	Plug & Socket Box with 4P MCB Cutout	SSEU304-SSC	5110
	5	Universal	Plug & Socket Box with 3P MCB Cutout	SSEU305-SSC-MCB3P	5210
			Plug & Socket Box with 4P MCB Cutout	SSEU305-SSC	5210

Final Distribution Products

- MCB
- Isolators
- MCB Distribution Boxes
- RCCB





Pole	Standard pack of	Rating	B Curve Cat. No.	MRP [₹]	C Curve Cat. No.	MRP (per unit)[₹]	Rating	Lower Rating Cat. No.	MRP (per unit)[₹]
1P	12 units	6A	BCHX10SPB06	285	BCHX10SPC06	285	0.5A 1A 2A 3A 4A 5A	BCHX10SPCL5 BCHX10SPC01 BCHX10SPC02 BCHX10SPC03 BCHX10SPC04 BCHX10SPC05	500 500 500 500 500 500
		10A	BCHX10SPB10	285	BCHX10SPC10	285			
		16A	BCHX10SPB16	285	BCHX10SPC16	285			
		20A	BCHX10SPB20	285	BCHX10SPC20	285			
		25A	BCHX10SPB25	285	BCHX10SPC25	285			
		32A	BCHX10SPB32	285	BCHX10SPC32	285			
		40A	BCHX10SPB40	695	BCHX10SPC40	695			
		50A	BCHX10SPB50	695	BCHX10SPC50	695			
		63A	BCHX10SPB63	705	BCHX10SPC63	705			
1P+N	6 units	6A			BCHX10SNC06	1000			
		10A			BCHX10SNC10	1000			
		16A			BCHX10SNC16	1000			
		20A			BCHX10SNC20	1000			
		25A			BCHX10SNC25	1000			
		32A			BCHX10SNC32	1000			
		40A			BCHX10SNC40	1490			
		50A			BCHX10SNC50	1490			
		63A			BCHX10SNC63	1535			
2P	6 units	6A	BCHX10DPB06	1055	BCHX10DPC06	1055	0.5A 1A 2A 3A 4A 5A	BCHX10DPCL5 BCHX10DPC01 BCHX10DPC02 BCHX10DPC03 BCHX10DPC04 BCHX10DPC05	1485 1485 1485 1485 1485 1485
		10A	BCHX10DPB10	1055	BCHX10DPC10	1055			
		16A	BCHX10DPB16	1055	BCHX10DPC16	1055			
		20A	BCHX10DPB20	1055	BCHX10DPC20	1055			
		25A	BCHX10DPB25	1055	BCHX10DPC25	1055			
		32A	BCHX10DPB32	1055	BCHX10DPC32	1055			
		40A	BCHX10DPB40	1640	BCHX10DPC40	1640			
		50A	BCHX10DPB50	1640	BCHX10DPC50	1640			
		63A	BCHX10DPB63	1685	BCHX10DPC63	1685			
3P	4 units	6A	BCHX10TPB06	1660	BCHX10TPC06	1660	0.5A 1A 2A 3A 4A 5A	BCHX10TPCL5 BCHX10TPC01 BCHX10TPC02 BCHX10TPC03 BCHX10TPC04 BCHX10TPC05	2030 2030 2030 2030 2030 2030
		10A	BCHX10TPB10	1660	BCHX10TPC10	1660			
		16A	BCHX10TPB16	1660	BCHX10TPC16	1660			
		20A	BCHX10TPB20	1660	BCHX10TPC20	1660			
		25A	BCHX10TPB25	1660	BCHX10TPC25	1660			
		32A	BCHX10TPB32	1660	BCHX10TPC32	1660			
		40A	BCHX10TPB40	2520	BCHX10TPC40	2520			
		50A	BCHX10TPB50	2520	BCHX10TPC50	2520			
		63A	BCHX10TPB63	2585	BCHX10TPC63	2585			
3P+N	3 units	6A			BCHX10TNC06	2135			
		10A			BCHX10TNC10	2135			
		16A			BCHX10TNC16	2135			
		20A			BCHX10TNC20	2135			
		25A			BCHX10TNC25	2135			
		32A			BCHX10TNC32	2135			
		40A			BCHX10TNC40	2890			
		50A			BCHX10TNC50	2890			
		63A			BCHX10TNC63	2955			
4P	3 units	6A	BCHX10FPB06	2230	BCHX10FPC06	2230	0.5A 1A 2A 3A 4A 5A	BCHX10FPCL5 BCHX10FPC01 BCHX10FPC02 BCHX10FPC03 BCHX10FPC04 BCHX10FPC05	2785 2785 2785 2785 2785 2785
		10A	BCHX10FPB10	2230	BCHX10FPC10	2230			
		16A	BCHX10FPB16	2230	BCHX10FPC16	2230			
		20A	BCHX10FPB20	2230	BCHX10FPC20	2230			
		25A	BCHX10FPB25	2230	BCHX10FPC25	2230			
		32A	BCHX10FPB32	2230	BCHX10FPC32	2230			
		40A	BCHX10FPB40	3175	BCHX10FPC40	3175			
		50A	BCHX10FPB50	3175	BCHX10FPC50	3175			
		63A	BCHX10FPB63	3250	BCHX10FPC63	3250			



HSN Code : 8536

Poles	Standard Pack of	Rating	Cat. No.	MRP (per unit) [₹]
2P	6 units	40A	BCHISODP40	715
	6 units	63A	BCHISODP63	880
3P	4 units	40A	BCHISOTP40	1270
	4 units	63A	BCHISOTP63	1455
4P	3 units	40A	BCHISOFP40	1490
	3 units	63A	BCHISOFP63	1615

MCB DISTRIBUTION BOXES



HSN Code : 8537

NEW



No. Of Way	No. of Modules (Incoming + Outgoing)	Cat. No. (Single Door)	MRP [₹]
4 WAY	4	BCHPSPNSD04W	1435
6 WAY	6	BCHPSPNSD06W	1535
8 WAY	8	BCHPSPNSD08W	1800
12 WAY	12	BCHPSPNSD12W	2355
16 WAY	16	BCHPSPNSD16W	3015

No. Of Way	Cat. No. (Double Door)	MRP [₹]
4 WAY	BCHPSPNDD04W	2310
6 WAY	BCHPSPNDD06W	2360
8 WAY	BCHPSPNDD08W	2710
12 WAY	BCHPSPNDD12W	3630
16 WAY	BCHPSPNDD16W	4635

NEW



No. Of Way	No. of Modules (Incoming + Outgoing)	Cat. No. (Single Door)	MRP [₹]
4 WAY	4	BCHPHTPNSD04W	4655
6 WAY	6	BCHPHTPNSD06W	5585
8 WAY	8	BCHPHTPNSD08W	6145

No. Of Way	Cat. No. (Double Door)	MRP [₹]
4 WAY	BCHPHTPNDD04W	5835
6 WAY	BCHPHTPNDD06W	7255
8 WAY	BCHPHTPNDD08W	9010

HSN Code : 8537



Description	No. of Modules (Incoming + Outgoing)	Cat. No. (Single Door)	MRP [₹]	Cat. No. (Double Door)	MRP [₹]
4 WAY, SPN DB	4	BCHSPNSD04W	1460	BCHSPNDD04W	2375
6 WAY, SPN DB	6	BCHSPNSD06W	1555	BCHSPNDD06W	2430
8 WAY, SPN DB	8	BCHSPNSD08W	1825	BCHSPNDD08W	2785
12 WAY, SPN DB	12	BCHSPNSD12W	2395	BCHSPNDD12W	3725
16 WAY, SPN DB	16	BCHSPNSD16W	3055	BCHSPNDD16W	4760

HSN Code : 8537



Description	No. of Modules (Incoming + Outgoing)	Cat. No. (Single Door)	MRP [₹]	Cat. No. (Double Door)	MRP [₹]
4 WAY, HTPN DB	8+12	BCHHTPNSD04W	4785	BCHHTPNDD04W	5995
6 WAY, HTPN DB	8+18	BCHHTPNSD06W	5740	BCHHTPNDD06W	7455
8 WAY, HTPN DB	8+24	BCHHTPNSD08W	6315	BCHHTPNDD08W	9260
12 WAY, HTPN DB	8+36	BCHHTPNSD12W	8375	BCHHTPNDD12W	13245

MCB DISTRIBUTION BOXES



HSN Code : 8537

Description	Cat. No.	No. of Modules (Incoming + Outgoing)	MRP [₹]
4 WAY, DD, MCB I/C, VERTICAL TPN DB	BCHVTPNDD04W-A	8+12	12990
6 WAY, DD, MCB I/C, VERTICAL TPN DB	BCHVTPNDD06W-A	8+18	16260
8 WAY, DD, MCB I/C, VERTICAL TPN DB	BCHVTPNDD08W-A	8+24	18315
12 WAY, DD, MCB I/C, VERTICAL TPN DB	BCHVTPNDD12W-A	8+36	23400

All above DB's are double door



HSN Code : 8537

Description	Cat. No.	Suitable for MCCB Frame	MRP [₹]
4 WAY, DD, 125A, 3P MCCB I/C VERTICAL TPN DB	BCHVTPNDD04W-B	FRAME 1	17700
8 WAY, DD, 125A, 3P MCCB I/C VERTICAL TPN DB	BCHVTPNDD08W-B	FRAME 1	20285
12 WAY, DD, 125A, 3P MCCB I/C VERTICAL TPN DB	BCHVTPNDD12W-B	FRAME 1	27475
4 WAY, DD, 250A, 3P MCCB I/C VERTICAL TPN DB	BCHVTPNDD04W-C	FRAME 2	21565
8 WAY, DD, 250A, 3P MCCB I/C VERTICAL TPN DB	BCHVTPNDD08W-C	FRAME 2	26350
12 WAY, DD, 250A, 3P MCCB I/C VERTICAL TPN DB	BCHVTPNDD12W-C	FRAME 2	30765

All above DB's are double door



HSN Code : 8537

Description	Cat. No.	Suitable for MCCB Frame	MRP [₹]
4 WAY, DD 125A 4P MCCB I/C, VERTICAL TPN DB	BCHVTPNDD04W-XA1B0	XA1/XB0/XD0	18590
8 WAY, DD, 125A, 4P MCCB I/C, VERTICAL TPN DB	BCHVTPNDD08W-XA1B0	XA1/XB0/XD0	21300
12 WAY, DD, 125A, 4P MCCB I/C, VERTICAL TPN DB	BCHVTPNDD12W-XA1B0	XA1/XB0/XD0	28850



HSN Code : 8537

Description	Cat. No.	No. of Modules (Incoming + Outgoing)	MRP [₹]
4 WAY, DD, 7 SEGMENT PHASE SEGREGATED DB	BCHPHSGDD04W	8+12+12	19455
6 WAY, DD, 7 SEGMENT PHASE SEGREGATED DB	BCHPHSGDD06W	8+12+18	21915
8 WAY, DD, 7 SEGMENT PHASE SEGREGATED DB	BCHPHSGDD08W	8+12+24	24475
12 WAY, DD, 7 SEGMENT PHASE SEGREGATED DB	BCHPHSGDD12W	8+12+36	31095

All above DB's are double door



HSN Code : 8537

Description	Cat. No.	No. of Modules (Incoming + Outgoing)	MRP [₹]
4 WAY, 40A, DD, PHASE SELECTOR DB	BCHPHSLDD04W-40		20010
6 WAY, 40A, DD, PHASE SELECTOR DB	BCHPHSLDD06W-40		20545
8 WAY, 40A, DD, PHASE SELECTOR DB	BCHPHSLDD08W-40		23005
12 WAY, 40A, DD, PHASE SELECTOR DB	BCHPHSLDD12W-40		26215
4 WAY, 63A, DD, PHASE SELECTOR DB	BCHPHSLDD04W-63		20170
6 WAY, 63A, DD, PHASE SELECTOR DB	BCHPHSLDD06W-63		20865
8 WAY, 63A, DD, PHASE SELECTOR DB	BCHPHSLDD08W-63		23970
12 WAY, 63A, DD, PHASE SELECTOR DB	BCHPHSLDD12W-63		26645

All above DB's are double door



HSN Code : 8537

Description	Cat. No.	No. of Modules (Incoming + Outgoing)	MRP [₹]
2 ROW, 13 MODULE, DD, ROW DB	BCHROWDB2R13	13	8895
3 ROW, 13 MODULE, DD, ROW DB	BCHROWDB3R13	13	10480
4 ROW, 13 MODULE, DD, ROW DB	BCHROWDB4R13	13	11610

All above DB's are double door

★ All above DB's are Non Stockable with leadtime of 45 days



HSN Code : 8537

Description	Cat. No.	No. of Modules (Incoming + Outgoing)	MRP [₹]
SPN-10A, P&S DB	BCHPSDBSPN10		1800
SPN-20A, P&S DB	BCHPSDBSPN20		1800
TPN-20A, P&S DB	BCHPSDBTPN20		5150
TPN-30A, P&S DB	BCHPSDBTPN30		5150



HSN Code : 8537

Description	Cat. No.	No. of Modules (Incoming + Outgoing)	MRP [₹]
SP, ONE WAY MCB DB	BCHOWMCBDBSP		745
DP, ONE WAY MCB DB	BCHOWMCBDBDP		745
TP, ONE WAY MCB DB	BCHOWMCBDBTP		805
FP, ONE WAY MCB DB	BCHOWMCBDBFP		805

RCCB



RCCB, Double Pole

HSN Code : 8536

Description	Cat. No.	MRP [₹]
25A - 30mA	BCHRCBR030DPC25	4135
40A - 30mA	BCHRCBR030DPC40	4225
63A - 30mA	BCHRCBR030DPC63	5675
25A - 100mA	BCHRCBR100DPC25	4180
40A - 100mA	BCHRCBR100DPC40	4335
63A - 100mA	BCHRCBR100DPC63	5795
25A - 300mA	BCHRCBR300DPC25	4180
40A - 300mA	BCHRCBR300DPC40	4640
63A - 300mA	BCHRCBR300DPC63	5795

All above RCCB's are 'AC' type



RCCB, Four Pole

HSN Code : 8536

Description	Cat. No.	MRP [₹]
25A - 30mA	BCHRCBR030FPC25	5325
40A - 30mA	BCHRCBR030FPC40	5480
63A - 30mA	BCHRCBR030FPC63	6165
25A - 100mA	BCHRCBR100FPC25	5480
40A - 100mA	BCHRCBR100FPC40	5715
63A - 100mA	BCHRCBR100FPC63	6165
25A - 300mA	BCHRCBR300FPC25	5480
40A - 300mA	BCHRCBR300FPC40	5745
63A - 300mA	BCHRCBR300FPC63	6165

All above RCCB's are 'AC' type

- Zone:** Effects
- Zone 1:** Usually no reactions.
 - Zone 2:** Usually no harmful effects.
 - Zone 3:** Muscle cramps can occur. There is normally no danger of ventricular fibrillation.
 - Zone 4:** Ventricular fibrillation may occur which can be fatal.



RCCB, Double Pole

HSN Code : 8536

Description	Cat. No.	MRP [₹]
25A - 30mA	BCHRCB030DPC25	4210
40A - 30mA	BCHRCB030DPC40	4300
63A - 30mA	BCHRCB030DPC63	5775
25A - 100mA	BCHRCB100DPC25	4250
40A - 100mA	BCHRCB100DPC40	4410
63A - 100mA	BCHRCB100DPC63	5905
25A - 300mA	BCHRCB300DPC25	4250
40A - 300mA	BCHRCB300DPC40	4720
63A - 300mA	BCHRCB300DPC63	5905

All above RCCB's are 'AC' type



RCCB, Four Pole

HSN Code : 8536

Description	Cat. No.	MRP [₹]
25A - 30mA	BCHRCB030FPC25	5420
40A - 30mA	BCHRCB030FPC40	5585
63A - 30mA	BCHRCB030FPC63	6280
25A - 100mA	BCHRCB100FPC25	5585
40A - 100mA	BCHRCB100FPC40	5825
63A - 100mA	BCHRCB100FPC63	6280
25A - 300mA	BCHRCB300FPC25	5585
40A - 300mA	BCHRCB300FPC40	5845
63A - 300mA	BCHRCB300FPC63	6280

All above RCCB's are 'AC' type

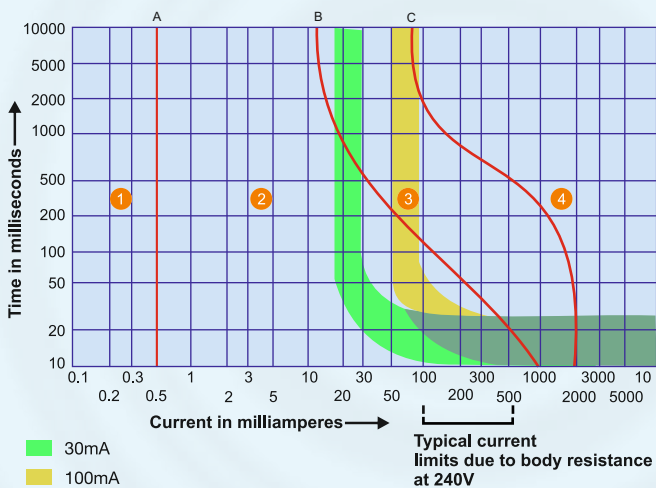

Effect of Current

Zone	Effects
Zone 1	Usually no reactions
Zone 2	Usually no harmful effects
Zone 3	Muscle cramps can occur. There is normally no danger of ventricular fibrillation.
Zone 4	Chances of ventricular fibrillation increased upto 5% (Curve C2) upto 50% (Curve C3) and above 50% beyond Curve C3. Effects such as cardiac arrest, breathing arrest and heavy burns may also occur.

Industrial Control & Protection

- AC Contactors, Accessories & Spares
 - BRAVO Contactor & OLR
 - FS1 Contactor
 - Freedom Contactor
 - Capacitor Duty Contactor
 - NHD Contactor
 - Mini Contactor
 - Definite Purpose Contactor
 - Citation Contactor
- Overload Relays
 - Citation Overload Relays
 - Freedom Overload Relays
- Electronic Overcurrent Relays (EOCR)
- Bhartia Overcurrent Relays (BOCR)
- Motor Protection Circuit Breakers (MPCB)
- Solid State Relays
- Soft Starters
- DC Contactors
- DC Magnetic Overload Relays
- Push Buttons, Indicating Lights, LEDs
- Punched Grid Resistors

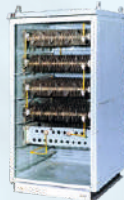
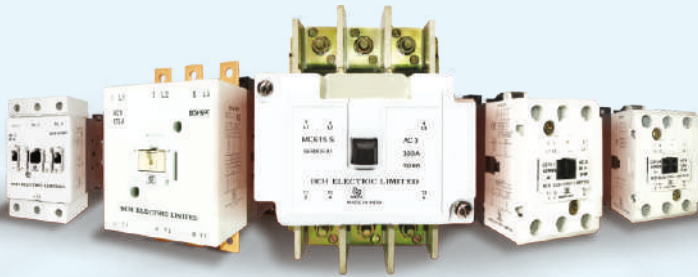

FREEDOM / FS1 RANGE



- Conforms to IEC 60947-4-1 / IS 13947
- No derating upto -20°C to 60°C
- 2 Pole, 3 Pole and 4 Pole versions
- Widest Range from 6A to 1200A in 7 frame sizes
- Snap Open design for easy inspection
- Self Lifting Screws for quick termination
- Superior grade material with high temperature withstand capacity
- : Ideal for stringent applications
- Most compact design
- Low VA burden coils
- Successfully tested for Type - 2 coordination



- Range : 5 to 60 KVAR
- Enhanced equipment life
- Compact design
- Conforms to IEC 60947-4-1 & IS 13947-4-1 (AC-6b) utilization category

BRAV Series CONTACTOR



- Range: 6A to 95A (3P & 4P)
- Common accessories
- Wide band coil as standard
- AC/DC coil voltages



BCH Series : 400A to 1200A

- Conforms to IEC60947-4-1 / IS 13947
- Insulation voltage upto 1000V
- Universal Control : Same coil for AC and DC Supply
- Delayed Drop Off feature for networks with transient power problem ensuring continuity of power supply
- Special magnet design for reduced shock and vibration
- Front open design for ease of inspection



BRAV Series

CONTACTOR

New



- Range: 6A to 95A (3P & 4P)
- Common accessories
- Wide band coil -30% to +20%
- Operating Temp - 20°C to +55°C



BCH

BCH
ELECTRIC
LIMITED

BRAVO Contactor 3 Pole

HSN Code : 8536



- Range 6A to 95A, 3 Pole 415V AC3 / 20A to 125A 4 Pole 415V AC1
- Conforms to IS / IEC 60947-4-1
- No of Built in Poles - 3Poles + 1NO/NC Aux Contact
- Rated Operational Voltage 415V
- Rated Insulation Voltage 690V
- Rated Impulse Voltage 6kV
- Ambient Temp - 20°C to +55°C
- Wide Band Coil -30% to +20%

Size	AC1 Rating	AC3 Rating 415V AC			AC Coil			DC Coil (dual coil design)	
		Amp	HP	KW	Aux Contact	Cat Code	MRP [₹]	Cat Code	MRP [₹]
Frame 1	20	6	3	2.2	1NO 1NC	BR30610* BR30601*	1385	BR3006DDC*	On request
	25	9	5.5	4	1NO 1NC	BR30910* BR30901*	1585	BR3009DDC*	
	25	12	7.5	5.5	1NO 1NC	BR31210* BR31201*	1715	BR3012DDC*	
	32	18	12	9	1NO 1NC	BR31810* BR31801*	2005	BR3018DDC*	
	40	25	15	11	1NO 1NC	BR32510* BR32501*	2750	BR3025DDC*	
Frame 2	50	32	20	15	1NO 1NC	BR33210* BR33201*	5845	-	-
	50	38	25	18.5	1NO 1NC	BR33810* BR33801*	6435	-	-
	50	40	30	22	1NO 1NC	BR34010* BR34001*	8085	-	-
Frame 3	60	40	30	22	1NO+1NC	BR34011*	On request	-	-
	70	50	34	25	1NO+1NC	BR35011*			
	80	65	50	37	1NO+1NC	BR36511*			
Frame 4	110	80	60	45	1NO+1NC	BR38011*	On request	-	-
	120	95	60	45	1NO+1NC	BR39511*			

* Refer Coil Voltage Table below

BRAVO Contactor (AC Control) 4 Pole

HSN Code : 8536

Size	AC1 Rating	Main Pole Configuration	Cat Code	MRP [₹]
Frame 1	20	4NO	BR4060*	1825
	25	4NO	BR4090*	1985
	32	4NO	BR4120*	2155
	40	4NO	BR4180*	2740
	50	4NO	BR4250*	3840
Frame 2	55	4NO	BR4320*	7735
	60	4NO	BR4380*	8395
Frame 3	60	4NO	BR44000*	On request
	80	4NO	BR46500*	
Frame 4	100	4NO	BR48000*	
	125	4NO	BR49500*	

* Refer Coil Voltage Table below

Bravo Control Relay (AC Control)



Aux Contact Combination	Cat Code	MRP [₹]
2NO+2NC	BRCR22*	1605
3NO+1NC	BRCR31*	1605
4NO	BRCR40*	1605

* Refer Coil Voltage Table below

* Coil Voltage Table

AC 50HZ	24	48	110	220	240	415
AC	U	W	A	B	K	M
DC	U3	W3	A3	B3	-	-

Coming Soon

New

BRAV Series Thermal Overload Relays



- Range 0.25A to 80A
- Conforms to IEC : 60947-4-1
- Relay Class : 10A
- Built in Single Phasing Protection
- Ambient Temperature Compensated
- Test Button for Checking Trip Mechanism
- Field convertible auto manual reset
- Contactor mounting type

Thermal Overload Relays BR318F1

HSN Code : 8536

	Protection Adjustment Range	For Use With Contactor	Cat Code	MRP [₹]
Frame 1	0.25-0.40A	BR306..40	BR318F13C	2230
	0.63-1.00A	BR306..40	BR318F13E	2230
	1.0-1.40A	BR306..40	BR318F13F	2230
	1.30-1.80A	BR306..40	BR318F13G	2230
	1.7-2.4A	BR306..40	BR318F13H	2230
	2.2-3.1A	BR306..40	BR318F13J	2230
	2.8-4.0A	BR306..40	BR318F13K	2230
	3.5-5.0A	BR306..40	BR318F13L	2230
	4.5-6.5A	BR306..40	BR318F13M	2230
	6.0-8.5A	BR306..40	BR318F13N	2230
	7.5-11A	BR306..40	BR318F13P	2230
	10.0-14.0A	BR306..40	BR318F13Q	2230
	13.0-19.0A	BR306..40	BR318F13R	2455
	18.0-25.0A	BR306..40	BR318F13S	2455
24.0-32.0A	BR306..40	BR318F13T	3340	
Frame 2	22.0-32.0A	BR34011..9511	BR318GF23B	On request
	29.0-42.0A	BR34011..9511	BR318GF23C	
	36.0-52.0A	BR34011..9511	BR318GF23D	
	45.0-63.0A	BR34011..9511	BR318GF23E	
	60.0-80.0A	BR34011..9511	BR318GF23F	



Spare Coil AC

AC Coil For Contactor	Cat Code	MRP [₹]
BR06F1 - 25F1 3P&4P	MCBRF134P*	445
BR32F2 TO 40F2 3P	MCBRF2A3P*	555
BR25F2 TO 38F2 4P	MCBRF2B4P*	555
BR34011 - 36511 3P	MCBRF33P*	On request
BR38011 - 39511 3P	MCBRF43P*	
BR44000 - 49500 4P	MCBRF44P*	

Accessories for Contactors



Description	For Use With	Mounting	Contacts	Cat Code	MRP [₹]
Auxiliary Contact Block	BR306..95 & BR4060..49500	Top	1NO	BRTAC10	370
		Top	1NC	BRTAC01	370
		Top	1NO+1NC	BRTAC11	555
		Top	2NO	BRTAC20	555
		Top	2NC	BRTAC02	555
		Top	2NO+2NC	BRTAC22	885
		Top	3NO+1NC	BRTAC31	885
		Top	1NO+3NC	BRTAC13	885
		Top	4NO	BRTAC40	885
Top	4NC	BRTAC04	885		
Mechanical Interlock	BR306..365 & BR4060..4380	Side	-	BRMIH640	555
	BR380..395 & BR44000..49500	Side	-	BRMIH8095	On request
Surge Suppressor	-	24-48V AC		BRSRG48V	
		110-240V AC		BRSRG240V	

Coming Soon

New

FS1 Contactor



- Range 9A to 80A, 415V AC3, 3Pole & 2Pole
- Conforms to IS / IEC 60947-4-1
- 3Poles with 1NO/NC Aux Contact as standard
- Rated Operational Voltage 415V
- Rated Insulation Voltage 690V
- Rated Impulse Voltage 6kV
- Ambient Temp - 20⁰C to +60⁰C

FS1 Contactor (AC Control)

HSN Code : 8536

Size	AC1 Rating	AC3 Rating 415V AC			3Pole			2Pole		
		Amp	HP	KW	Aux Contact	Cat Code	MRP [₹]	Aux Contact	Cat Code	MRP [₹]
B	20	9	5.5	4	1NO	CN14BNS3*	1565	1NO	CN14BNS2*	1370
					1NC	CN14BNC3*		1NC	CN14BNC2*	
C	20	12	7.5	5.5	1NO	CN14CNS3*	1765	1NO	CN14CNS2*	1540
					1NC	CN14CNC3*		1NC	CN14CNC2*	
D	20	16	10	7.5	1NO	CN14DNS3*	1855	-	-	-
					1NC	CN14DNC3*		-	-	
D	22	18	10	7.5	1NO	CN14D1NS3*	2055	1NO	CN14D1NS2*	1795
					1NC	CN14D1NC3*		1NC	CN14D1NC2*	
E	40	25	15	11	1NO	CN14EN3*10	2650	-	CN14EN2*10	2325
					1NC	CN14EN3*01		-	CN14EN2*01	
F	40	32	20	15	1NO	CN14FN3*10	5640	-	CN14FN2*10	4940
					1NC	CN14FN3*01		-	CN14FN2*01	
F1	40	38	30	22	1NO	CN14F1N3*10	8055	-	-	-
					1NC	CN14F1N3*01		-	-	
G	60	40	30	22	1NO + 1NC	CN14GN3*11	8450	-	CN14GN2*	7390
H	75	50	33.5	25	1NO + 1NC	CN14HN3*11	10405	-	CN14HN2*	9110
J	80	65	50	37	1NO + 1NC	CN14JN3*11	14100	-	CN14EN2*	9415
K2	100	80	53	40	1NO + 1NC	CN14K2N3*11	16545	-	CN14K2N2*	12935

* For standard coil voltage codes refer Page No.48

Freedom Series 3 Pole (AC Control)

HSN Code : 8536



Size	AC1 Rating	AC3 Rating 415 V			Aux. Contact	Cat. No.	MRP [₹]	Lot Size
		A	HP	KW				
A	20	6	3	2.2	1NO	CE15ANS3 ■ B-N	1645	1
					1NC	CE15ANC3 ■ B-N		
B	20	9	5.5	4	1NO	CE15BNS3 ■ B-N	1700	
					1NC	CE15BNC3 ■ B-N		
C	20	12	7.5	5.5	1NO	CE15CNS3 ■ B-N	1955	
					1NC	CE15CNC3 ■ B-N		
D	32	16	10	7.5	1NO	CE15DN3 ■ B10-N	2190	
					1NC	CE15DN3 ■ B01-N		
	32	18	10	7.5	1NO	CE15D1N3 ■ B10-N	2200	
					1NC	CE15D1N3 ■ B01-N		
E	40	25	15	11	1NO	CE15EN3 ■ B10-N	3070	
					1NC	CE15EN3 ■ B01-N		
F	40	32	20	15	1NO	CE15FN3 ■ B10-N	6085	
					1NC	CE15FN3 ■ B01-N		
G	60	40	30	22	1NO+1NC	CE15GN3 ■	9020	
					-	CE15GN3 ■ NB	8545	
H	75	50	33.5	25	1NO+1NC	CE15HN3 ■	11340	
					-	CE15HN3 ■ NB	10910	
J	80	65	50	37	1NO+1NC	CE15JN3 ■	15415	
					-	CE15JN3 ■ NB	14980	
K	80	73	50	37	1NO+1NC	CE15KN3 ■	15835	
					-	CE15KN3 ■ NB	15335	
	80	75	50	37	1NO+1NC	CE15K1N3 ■	15975	
					-	CE15K1N3 ■ NB	15415	
K-1	115	80	53	40	1NO+1NC	BCH15KT.3.11. ■	17665	
L	125	95	62	47	1NO+1NC	BCH15LT.3.11. ■	21340	
# M	135	110	80	60	1NO+1NC	BCH15MT.3.11. ■	26205	
# N	230	150	100	75	1NO+1NC	BCH15NT.3.11. ■	34860	
# P	250	175	125	95	1NO+1NC	BCH15PT.3.11. ■	43440	
# P1	250	185	125	95	1NO+1NC	BCH15P1T.3.11. ■	46075	
R	300	200	150	100	1NO+1NC	MCE15RN3 ■ 7	53425	
S0	315	265	186	140	1NO+1NC	MCE15SON3 ■ 7	62385	
@ S	315	300	220	160	1NO+1NC	MCE15SN3 ■ 7	68890	

With Universal AC/DC coil, In BCH15MT-220V DC coil Not Available
 @ 325A, AC3 rating is also available on request

Freedom Series 3 Pole (AC/DC Control)

HSN Code : 8536



Size	AC1 Rating(A)	AC3 Rating 415 V			Aux. Contact	Cat. No.	MRP [₹]
		A	HP	KW			
BCH54	600	400	320	240	2NO+2NC	BCH54.3.22. ■	88375
BCH55	600	450	320	240	2NO+2NC	BCH55.3.22. ■	113625
BCH57	760	550	420	315	2NO+2NC	BCH57.3.22. ■	128075
BCH62	1000	700	533	400	2NO+2NC	BCH62.3.22. ■	227315
BCH64	1000	860	666	500	2NO+2NC	BCH64.3.22. ■	366735
BCH76	1200	1000	800	600	1NO+2NC	BCH76.3.12. ■	665310
BCH78	1350	1200	933	700	1NO+2NC	BCH78.3.12. ■	705140

■ For Standard Coil Voltage Codes refer page 48 ■ For DC coil in MCE15RN add ₹600/- to MRP
 ■ For Non Standard Coil Voltages, extra MRP to be added to Contactor MRP for :

Contactor size { A ~ K @ ₹ 40
 K-1 ~ S @ ₹ 110
 BCH 54 ~ BCH 57 @ ₹ 220

Freedom series 4 Pole contactors (AC Control)

HSN Code : 8536

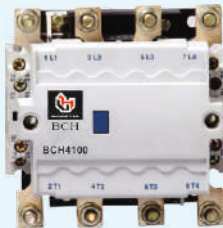

- 20A to 500A AC1 (4 Pole)
- As per IS/IEC 60947-4-1
- Wide band coil 40A to 100A AC1

AC1 rating (A)	Cat No.	Aux Contact	MRP [₹]
20	CE15CN4-B-N	#	2270
40	BCH4040	#	3350
63	BCH4063	#	8455
80	BCH4080	#	13105
100	BCH4100	#	16905
130	BCH4130	#	19730
160	BCH15MNO.4.11	1NO+1NC	27890
200	BCH15MN.4.11	1NO+1NC	33025
250	BCH15NN.4.11	1NO+1NC	37165
300	BCH15PN.4.11	1NO+1NC	64365
400	BCH4400	2NO+2NC	108670
500	BCH4500	2NO+2NC	137620

DC coils also available on request # Aux contacts to order separately

Freedom Contactor : 3 Pole DC Control - Type Ce15 (Dual coil design)

HSN Code : 8536

Common Accessories 'upto 73A'



AC3 (A) at 415VAC	KW	Aux Contact	Cat No.	MRP [₹]
6	2.2	1NC	CE15ANC3-N	2335
		1NO	CE15ANS3-N	
9	4.4	1NC	CE15BNC3-N	2475
		1NO	CE15BNS3-N	
12	5.5	1NC	CE15CNC3-N	2610
		1NO	CE15CNS3-N	
16	7.5	-	CE15DN3-N	3155
25	11	-	CE15EN3-N	4280
32	15	-	CE15FN3-N	9035
40	22	-	CE15GN3	10700
50	25	-	CE15HN3	13645
65	37	-	CE15JN3	16220
73	37	-	CE15KN3	19095
75	37	-	CE15K1N3	19095

■ For Coil Voltage Codes refer Table on page 48

Control Relays Freedom Series

HSN Code : 8536

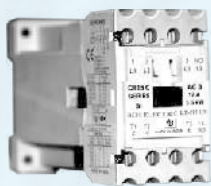

DC Control

- Standard voltages 24VDC , 110VDC , 220VDC

Size	Contact Configuration	Cat No.	MRP [₹]		Lot Size
			AC Coil	DC Coil# (Dual Coil Design)	
CR	2NO+2NC	D15CR22-N	1855	2845	1
	3NO+1NC	D15CR31-N			
	4NO	D15CR40-N			

Pure DC FS Contactor 3 Pole DC Control - Type CE16

Pure DC Control Relay

HSN Code : 8536



AC3 (A) at 415VAC	KW	Aux Contact	Cat No.	MRP [₹]	Aux Contact	Cat No.	MRP [₹]
9.1	4	1NO	CE16BNS3*B	2595	2NO+2NC	D16CR22*	2975
		1NC	CE16BNC3*B				
12	5.5	1NO	CE16CNS3*B	2735	3NO+1NC	D16CR31*	2975
		1NC	CE16CNC3*B				
16	7.5	1NO+1NC	CE16DN3*B	3330	4NO	D16CR40*	2975
25	11	1NO+1NC	CE16EN3*B	4580			
32	15	1NO+1NC	CE16FN3*B	9525			

*Coil Codes : Pure DC

24V	48V	110V	220V
U1	W1	A1	B1

■ For Standard Coil Voltage Codes refer page 48

■ For Non Standard Coil Voltages, extra MRP to be added to Contactor / Control relay MRP for :

Contactor size { A - K @ ₹ 40
BCH15MN ~ BCH15PN @ ₹ 110
D15CR ~ D16CR @ 40

Freedom series Capacitor duty contactor (AC Control)

HSN Code : 8536



kVAR rating at 415V 3Ph 50Hz	Size	Cat No.	Aux Contacts	MRP [₹]
5	B	CCD.05.11.▣	1NO+1NC	3270
10	C	CCD.10.11.▣	1NO+1NC	3550
15	E	CCD.15.11.▣	1NO+1NC	5185
20	F	CCD.20.11.▣	1NO+1NC	6085
26	G	CCD.26.11.▣	1NO+1NC	7460
30	H	CCD.30.11.▣	1NO+1NC	11845
40	K	CCD.40.11.▣	1NO+1NC	18040
50	KT	CCD.50.21.▣	2NO+1NC	18955
60	LT	CCD.60.21.▣	2NO+1NC	21280

▣ For Standard Coil Voltage refer table on page no. 48

▣ For Non Standard Coil Voltages, extra MRP to be added to Contactor MRP for : Contactor size { CCD.05 - CCD.40 @ ₹40
CCD.50 - CCD.60 @ ₹110

2 Pole Contactors



- ▣ 12, 16, 20, 25, 32 and 40 A rating
- ▣ Wide termination space

'NHD' Series 2 Pole Contactor

HSN Code : 8536

Ith (A)	AC3 (A) 240V AC	Cat. No.	MRP [₹]	Lot Size
20	12	CPG 212 ▣	1720	1
25	16	CPG 216 ▣	1960	
35	20	CPG 220 ▣	2490	
40	25	CPG 225 ▣	2915	
40	32	CPG 232 ▣	3565	
50	40	CPG 240 ▣	4240	

▣ For Coil Voltage Codes refer Table on page 48

4 Pole Contactors



- ▣ Superior Weld Resistant Contacts
- ▣ Rugged and heavy duty
- ▣ High Grade moulding for extremely long life
- ▣ Encapsulated Coil
 - : Shock Proof & Moisture Proof
 - : Withstand large voltage fluctuations

'NHD' Series 4 Pole Contactor

HSN Code : 8536

Size	AC1 (A)	AC3 Rating at 415 V			Cat. No.	MRP [₹]	Lot Size
		(A)	HP	KW			
CP12	20	12	7.5	5.5	CP12N ▣	3270	1
00	20	16	10	7.5	C00N ▣	3640	
CP20	30	20	12.5	9.3	CP20N ▣	4490	
0	32	25	15	11	N0N ▣	6610	
01	40	32	20	15	N01N ▣	9355	
1	50	40	25	18.5	N1N ▣	11890	

HSN Code : 8538

Description	Orientation	Cat. No.	MRP [₹]	Lot Size
Auxiliary Contact Blocks - NHD	1NO	001CB10	400	1
	1NO+1NC	001CB11	475	
	2NO	001CB20		
	2NC	001CB02		

▣ Standard coil voltages are 24, 110, 220/240 & 380/415 VAC, 50 Hz. For voltage codes refer Table on page 48

New

Mini Contactors



Mini Contactor AC Coil HSN Code : 8536

Rating AC3	Cat no.	Aux Contact (NO/NC)	MRP [₹]
07	CA1507P3001A***F	1NC	1615
07	CA1507P3010A***F	1NO	1615
09	CA1509P3001A***F	1NC	1745
09	CA1509P3010A***F	1NO	1745
12	CA1512P3001A***F	1NC	1855
12	CA1512P3010A***F	1NO	1855
16	CA1516P3001A***F	1NC	2195
16	CA1516P3010A***F	1NO	2195

Mini Contactor DC Coil HSN Code : 8536

Rating AC3	Cat no.	Aux Contact (NO/NC)	MRP [₹]
07	CA1507P3001D***	1NC	2355
07	CA1507P3010D***	1NO	2355
09	CA1509P3001D***	1NC	2445
09	CA1509P3010D***	1NO	2445
12	CA1512P3001D***	1NC	2685
12	CA1512P3010D***	1NO	2685
16	CA1516P3001D***	1NC	2960
16	CA1516P3010D***	1NO	2960

*** Replace with suitable coil voltage given in Table below



Mini Control Relays AC Coil

HSN Code : 8536

Rating AC1	Cat no.	Aux Contact (NO/NC)	MRP [₹]
16	CR1516P0022A***F	22	1875
16	CR1516P0031A***F	31	1875
16	CR1516P0013A***F	13	1875
16	CR1516P0040A***F	40	1875
16	CR1516P0004A***F	04	1875

Mini Controls Relays DC Coil

HSN Code : 8536

Rating AC1	Cat no.	Aux Contact (NO/NC)	MRP [₹]
16	CR1516P0022D***	22	2485
16	CR1516P0031D***	31	2485
16	CR1516P0013D***	13	2485
16	CR1516P0040D***	40	2485
16	CR1516P0004D***	04	2485

*** Replace with suitable coil voltage given in Table below

Coil Voltage Table

AC, 50 Hz	24	48	110	120	120	230/240	400	415	480	600
DC	12	24	110	125	250					

Bimetal Thermal Overload Relays



Description	Cat no.	MRP [₹]
0.28 ~ 0.4A	MC15BRL40	2295
0.4 ~ 0.63A	MC15BRL63	2295
0.56 ~ 0.8A	MC15BRL80	2295
0.8 ~ 1.2A	MC15BRM12	2295
1.2 ~ 1.8A	MC15BRM18	2295
1.8 ~ 2.8A	MC15BRM28	2295
2.8 ~ 4A	MC15BRM40	2320
4 ~ 06.3A	MC15BRM63	2320
5.6 ~ 8A	MC15BRM80	2320
7 ~ 10A	MC15BRH10	2320
8 ~ 12.5A	MC15BRH12	2365
10 ~ 15A	MC15BRH15	2365
11 ~ 17A	MC15BRH17	2365

Accessories

Auxiliary Contacts Front Mounted for Mini Contactor



Description	Cat no.	MRP [₹]
2 NO	MA15AF20	510
1 NO + 1 NC	MA15AF11	510
2 NC	MA15AF02	510
4 NO	MA15AF40	800
2 NO + 2 NC	MA15AF22	800
4 NC	MA15AF04	800
3 NO + 1 NC	MA15AF31	800
1 NO + 3 NC	MA15AF13	800

Auxiliary Contacts Front Mounted for Control Relay

Description	Cat no.	MRP [₹]
2 NO	MR15AF20	510
1 NO + 1 NC	MR15AF11	510
2 NC	MR15AF02	510
4 NO	MR15AF40	800
2 NO + NC	MR15AF22	800
4 NC	MR15AF04	800
3 NO + 1 NC	MR15AF31	800
1 NO + 3 NC	MR15AF13	800



Mechanical Interlock

Description	Cat no.	MRP [₹]
Front Mounted Mech. Interlock	M15AMIL	460



Reversing Wiring Module

Description	Cat no.	MRP [₹]
Reversing Power Wiring Module	M15A16LDRW	420
	M15A16LNRW	420



Surge Suppressor RC Type

Description	Cat no.	MRP [₹]
12-24V AC 50/60Hz	M15ASSR024	760
24-48V AC 50/60Hz	M15ASSR048	760
48-127V AC 50/60Hz	M15ASSR127	760
127-250V AC 50/60Hz	M15ASSR250	760
250-380V AC 50/60Hz	M15ASSR380	760
380-510V AC 50/60Hz	M15ASSR510	760

Surge Suppressor Varistor Type

Description	Cat no.	MRP [₹]
12-48V AC/12-60V DC	M15ASSV048	755
50-127V AC/60-180V DC	M15ASSV127	755
130-275V AC/80-300V DC	M15ASSV275	755
270-380V AC/300-510V DC	M15ASSV380	755
400-510V AC	M15ASSV510	755

Description	Cat no.	MRP [₹]
Surge Supr. Diode 12-600VDC	M15FSSD600	240

Definite Purpose Contactors

HSN Code : 8536



- Quick connect plugin terminals
- Specially designed low VA coil

1 Pole				2 Pole			
AC3 (A)	Type	Cat. No.	MRP [₹]	AC3 (A)	Type	Cat. No.	MRP [₹]
25	1 Pole	CPD251CK	960	20	2P, 140-200VAC	CPDN202BL	1055
25	1 Pole with Neutral	CPD251NCK	980	25	2P, 220-240VAC	CPD252H	1105
40	1 Pole	CPD401CK	1035	25	2P, 415VAC	CPD252M	
40	1 Pole with Neutral	CPD401NCK	1115	40	2P, 220-240VAC	CPD402H	1165
				40	2P, 415VAC	CPD402M	

*wide band AC coil voltages for Defintie purpose Contactor

Contactor	Cat No.	Voltage		
		170-240VAC	290-415VAC	140V-200VAC
25A 1P	CPD251*	KL	ML	BL
20A 2P	CPD202*			
40A 1P	CPD401*			



Citation Series 3 Pole AC Control

HSN Code : 8536

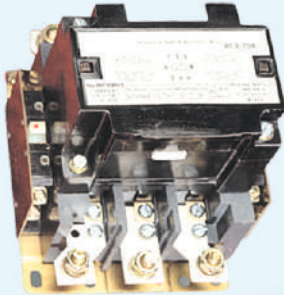

Size	AC3 Rating at 415 V			Cat. No. (with Aux. contact 2NO+2NC)	MRP [₹]	Cat. No. (with Aux. contact 1NO+1NC)	MRP [₹]	Cat. No. (without Aux. contact)	MRP [₹]
	Amps	HP	KW						
C4	32	20	15	C4NE22 ■	8285	C4NE11 ■	7745	C4NE00 ■	6870
D	40	30	22	MC10DN22 ■	13110	MC10DN11 ■	11535	MC10DN00 ■	11455
D1	50	33.5	25	MC10D1N22 ■	15420	MC10D1N11 ■	14510	MC10D1N00 ■	13600
D2	55	33.5	25	MC10D2N22 ■	16200	MC10D2N11 ■	15300	MC10D2N00 ■	14700
E	70	50	37	MC10EN22 ■	23465	MC10EN11 ■	22985	MC10EN00 ■	22540
E1	75	50	37	MC10E1N22 ■	24500	MC10E1N11 ■	23975	MC10E1N00 ■	23475

■ Standard coil voltages are 24, 110, 220, 240 & 415 VAC, 50 Hz. For voltage codes refer Table on page 49

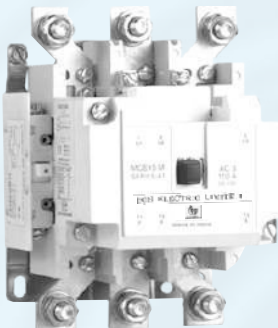

HSN Code : 8536

Size	AC1 Rating	AC3 Rating 415 V			Aux. Contact	Cat. No.	MRP [₹]	Lot Size
		A	HP	KW				
L	140	80	53	40	1NO+1NC	MCE15LN3 ■ 5	21780	1
M	150	95	62	47	1NO+1NC	MCE15M0N3 ■ 5	26125	
M-5	150	110	80	60	1NO+1NC	MCE15MN3 ■ 5	31965	
N	300	140	100	75	1NO+1NC	MCE15NN3 ■ 7	47665	1
Q	300	185	120	90	1NO+1NC	MCE15QN3 ■ 7	53965	

Other Freedom Series Contactors

Freedom Series 3 Pole AC Control

Size	Ac1 Rating	AC3 Rating 415 V			Aux. Contact	Cat. No.	MRP[₹]	Lot Size
		A	HP	KW				
D	32	16	10	7.5	1NO+1NC	CE15DN3 ■ B-N	2475	1
					-	CE15DN3 ■ -N	2050	
	32	18	10	7.5	1NO+1NC	CE15D1N3 ■ B-N	2490	
					-	CE15D1N3 ■ -N	2060	
E	40	25	15	11	1NO+1NC	CE15EN3 ■ B-N	3355	
					-	CE15EN3 ■ -N	2855	
F	40	32	20	15	1NO+1NC	CE15FN3 ■ B-N	6370	
					-	CE15FN3 ■ -N	5775	

■ For Standard Coil Voltage refer table on pageno. 48

■ For Non Standard Coil Voltages, extra MRP to be added to Contactor MRP for : Contactor size { D ~ F @ ₹40
C4 ~ E @ ₹50
L ~ Q @ ₹110

Freedom Series contactors Add-on accessories for sizes A to K, CR, BCH15KT to BCH15PT, R, S0 & S

HSN Code : 8538

Accessories	Configuration	Cat No.	Contactors Type	MRP [₹]	
Aux. Contact Block (side Mounting)	1NO	C320KGSR10	CE15 & CR	320	
	1NO+1NC	C320KGSR11		755	
	1NC	C320KGSR01		320	
	2NO	C320KGSR20		755	
	1NO+1NC	BCH15S11	BCH15	910	
	1NO+1NC	MC320KB11	MCE15R	1195	
	1NO+1NC (Late break type)	MC320KAS11	MCE15S0 & MCE15S	1155	
	2NO+2NC	EF22	BCH54 to BCH64	9210	
	1NO+1NC	EB11	BCH76 to BCH78	14310	
	New	1NO+1NC (1st left)^	BCH4A04041SL11	BCH4040	1085
		1NO+1NC (1st right)^	BCH4A04041SR11	BCH4040	1085
1NO+1NC (1st left)^		BCH4A06131SL11	BCH4063-130	1160	
1NO+1NC (1st right)^		BCH4A06131SR11	BCH4063-130	1160	
4th Neutral Switching Pole	800A	NP800/5	BCH54 to 57	47235	
	1000A	NP1000/6	BCH62 to 64	56695	
	1000A	NP1000/7	BCH76 to 78	64540	
Aux. Contact Block (Front Mounting)	1NO	C320KGTC10	CE15, CR	320	
	1NC	C320KGTC01		455	
	2NO	C320KGT*20			
	2NC	C320KGT*02			
	1NO+1NC	C320KGT* 11			785
	2NO+2NC	C320KGT*22			
	3NO+1NC	C320KGT* 31			
	4NO	C320KGT*40			
	1NO+3NC	C320KGT*13			
	4NC	C320KGT*04			
	4NO	BCH15T40	BCH15	1745	
	3NO+1NC	BCH15T31		1395	
	2NO+2NC	BCH15T22			
	1NO+1NC	BCH15T11		485	
1NO	BCH15T10				
1NC	BCH15T01				
New	1NO+1NC^	BCH4A0413T11	BCH4040-063	710	
	Pneumatic Timer Block "ON/OFF" Delay site selectable	1NO+1NC (0.1 to 30 sec)	C320TP1	CE15 & CR	2125
1NO+1NC (10 to 180 sec)		C320TP2			
Mechanical Interlocks	-	C321KM60	CE15 & CR	700	
	-	MC321KM3	MCE15R to MCE15S	2030	
	Horizontal	BM5H	BCH54 to 57	12150	
		BM6H	BCH62 to 64	21240	
		BM7H	BCH76 to 78	56230	
	Vertical	BM5V	BCH54 to 57	12150	
		BM6V	BCH62 to 64	21240	
		BM7V	BCH76 to 78	49910	
	Horizontal	BM0H	BCH15KT/LT/MT	690	
		BM3H	BCH15NT/PT/MN/NN/PN	745	
		BCH4M0404	BCH4040	725	
		BCH4M0608	BCH4063-080	1460	
		BCH4M1013	BCH4100-130#	6760	
BCH4M4040		BCH4400	11500		

^ Minimum order qty 10 nos.

Mech. Interlock it for BCH4100 / 130 comes with 2 left & 2 right side add-on aux. contact blocks i.e. 4NO + 4NC

*Add suffix C for power contactors, R for control relays. The suffix C/R denote terminal marking as per standard EN5001 on BS5583 on add on aux. contact blocks used with contactors / control relays

Add-on accessories for sizes

A to K, CR, BCH15KT to BCH15PT, R, S0 & S

HSN Code : 8538



Accessories	Configuration	Cat No.	Contactors Type	MRP [₹]
Coil Surge Suppressors	24-48V (50/60Hz)	MC320LR11	CE15, CR	675
	110-240V (50/60Hz)	MC320LR12		
Mechanical latch #	§ to complete the cat no. suffix code given	AM5- §	BCH54 to BCH57	30625
		AM6 §	BCH62 to BCH64	43315

Mechanical latch are supplied with AC coils only

§ Coil Voltage suffix code for Mechanical latch AM5 & AM6

Coil voltage	110-120	220-240	380-415	440-480
Suffix Code	AW4	BA4	LB4	CB4

Accessories for Citation contactors size - L, M, M-5, N, Q, C4, D & E type

HSN Code : 8538

Accessories	Configuration	Cat No.	Contactors Type	MRP [₹]
Aux. block side mounting	1NO+1NC	C320KGM11	L, M & M-5	1030
	1NO+1NC	MC320KB11	N, Q, R & S	1195
Aux. block add-on (Late break type)	1NO+1NC	MC320KAS11	L, M, M-5, N & Q	1155
	1NO+1NC	AC34EA11	C4, D & E	840
Mechanical Interlock		MC321KM1	C4 & D	855
		MC321KM2	L, M, M-5 & E	920
		MC321KM3	N & Q	2030
Base block	1NO+1NC	MC320KB2	C4 & D	935
	1NO+1NC	AC35EB11	E	910

Spare Contacts set for Freedom Contactors

HSN Code : 8538

Size	Consisting of	Cat. No.	MRP [₹]
A	Complete top housing Consisting of fixed & moving contacts	SBANS3 SBANC3 SBAN4	1445
B		SBBNS3 SBBNC3 SBBN4	1530
C		SBCNS3 SBCNC3 SBCN4	1665
D		SBDN3	1990
E		SBEN3	2335
F		SBFN3	4565
G	6 Fixed contacts 3 Moving Contacts	6-65-4	4005
H	3 springs	6-65-6	4945
J	6 Arc Bonnets	6-65-15	6730
K	3 Spring Retainer	6-65-17	6955
BCH15KT	Complete set of 6 fixed & 3 moving contacts with hardware, contact springs, spring retainers and arc runners	CP-BCH15KT-3	7075
BCH15LT		CP-BCH15LT-3	8120
BCH15MT		CP-BCH15MT-3	8735
BCH15NT		CP-BCH15NT-3	14420
BCH15PT		CP-BCH15PT-3	14420
		CP-BCH15P1T-3	14850
BCH15MN0		CP-BCH15MN0-4	17360
BCH15MN		CP-BCH15MN-4	18585
BCH15NN		CP-BCH15NN-4	20380
BCH15PN		CP-BCH15PN-4	21295
R	6 Fixed contacts 3 Moving contacts 12 CSK screws & washers	6-288	26280
S0	3 Springs Spring retainers	6-286-S0	32970
S	Self tapping screws & washers 6 Arc Chute assly & screws	6-286	33265
BCH54	Complete set of 6 fixed & 3 moving contacts with hardware, contact springs, spring retainers and arc runners	CP-BCH54-3	41515
BCH55		CP-BCH55-3	47860
BCH57		CP-BCH57-3	67420
BCH62		CP-BCH62-3	123200
BCH64		CP-BCH64-3	165205
BCH76		CP-BCH76-3	360265
BCH78		CP-BCH78-3	404830

Spare Contacts set for NHD & Citation Contactors

HSN Code : 8538

Size	Consisting of	Cat.No.	MRP [₹]
C00N N0N N01N N1N	(4 - Pole contact kit) 8 Fixed main contacts 4 Moving main contacts 4 Spring & 4 retainers	SP90A1 SP90B1 SP90D1 SP90C1	1465 2755 3935 4830
C00N N0N N01N N1N	(1 - Pole contact kit) 2 Fixed main contacts 1 Moving main contacts 1 Spring & 1 retainers	SP90A01 SP90B01 SP90D01 SP90C01	395 705 1020 1235
CPG216 CPG225 CPG240	4 Fixed contacts 2 Main contacts 2 Spring retainers	CPG162PSP CPG252PSP CPG402PSP	765 1900 2970
C4	6 Fixed main contacts 6 Pan head screws 6 Helical lock washers	SP34K	3840
MC10D	6 Fixed Main Contacts 3 Compression springs 3 Retainers	6-334	5295
MC10E	Same as above plus 6 Blow outs 6 M5/M4 self tapping screws	6-335	9975
L	6 Fixed Contacts 6 Pan Head Screws	6-385-L0	7670
M	6 Helical Lock Washers 3 Moving contacts	6-385-M	8630
M-5	3 Springs, 3 Retainers 6 Blowouts 6 self tapping screws	6-385	8725
N	6 Fixed contacts 12 CSK screws & washers	6-293	23140
Q	3 Moving contacts 3 Springs, Spring Retainers, Self tapping screws & Washers	6-288-Q	25380
New BCH4	Contact kit BCH4040 Contact kit BCH4063 Contact kit BCH4080 Contact kit BCH4100 Contact kit BCH4130 Contact kit BCH4400	- BCH4K06 BCH4K08 BCH4K10 BCH4K13 BCH4K40	- 4345 6060 7525 9200 47140

Spare ARC chambers - BCH15KT to BHC15PT, BCH54 to BCH78

HSN Code : 8538

Contactors	Cat. No.	MRP [₹]
BCH15KT	PF-BCH15KT	1055
BCH15LT	PF-BCH15LT	
BCH15MT	PF-BCH15MT	1825
BCH15NT	PF-BCH15NT	
BCH15PT	PF-BCH15PT	
BCH54/BCH55/BCH57 (for all 3 poles)	PF-BCH5	12495
BCH62/BCH64 (for all 3 poles)	PF-BCH6	34265
BCH76/78 (for single pole)	3PF-BCH78	70425

Spare Coil - size CR, A to K, BCH4, MCE15R, MCE15S0, MCE15S, BCH15KT to BCHPT, BCH54 to BCH78

HSN Code : 8538

Size	For Size	Cat. No.	MRP [₹]
Magnetic coil	CR, A,B, C	MC15CW ■	790
	CE16, D16 (Pure DC)	MC16FW ■	1260
	D, E, F	MC15FW ■	880
	G, H, J, K	MC15KW ■	2265
	BCH15KT/LT	B02. ■	2120
	BCH15MT	B022. ■	3615
	BCH15NT / PT / MN / NN / PN	B031. ■	7200
	R, S0, S	9-2412- ■	6535
	BCH4040	BCH4C0404 ■	705
	New BCH4063-080	BCH4C0608 ■	775
	BCH4100-130	BCH4C1013 ■	2170
	BCH4400	BCH4C4040 ■	13340
	Magnetic coil (set of two)	BCH54/ BCH55/ BCH57	B51. ■
Feeder group	FG51. ■		14930
Magnetic coil (set of two)	BCH62/ BCH64	B61. ■	43355
Feeder group		FG61. ■	50190
Magnetic coil (set of two)	BCH76/ BCH78	B8- ■	114850
Feeder group		FG78- ■	115305

- To specify coil voltage please refer page no.48
- For Non Standard Coil Voltages, extra MRP to be added to Coil MRP for :
 Contactor size
 - A ~ K @ ₹40
 - CR, CE16, D16 @ ₹40
 - BCH15KT ~ PN @ ₹110, R ~ S @ ₹110
 - BCH54 ~ BCH57 @ ₹220

Note : Coil set for BCH54 to BCH78 contactors consists of 2 half coils. Magnetic coil & Feeder group must have the same control voltage. For eg. If coil voltage is changed from 110V to 220V then Feeder group should also be changed to 220V

Spare Coil - NHD & Citation Contactors

HSN Code : 8538

Description	Cat. No.	MRP [₹]	Lot size
Carrier for NHD	SP90CC	125	1
Carrier for CPG	CPG2PCC	80	1
Magnetic coil for NHD	SP90MC*	530	10
Magnetic coil for MCE15L, MCE15M0, MCE15M	9-2268- ■	2970	1
Magnetic coil for MCE15N & MCE15Q	9-2412- ■	6535	1
Magnetic coil for C4 & MC10D	9-2267- ■	1855	1
Magnetic coil for MC10E type	9-2268- ■	2970	1

- To specify coil voltage please refer page no. 48
- For Non Standard coil voltages, extra MRP to be added to coil MRP for :
 Contactor size :
 - L ~ Q @ ₹110
 - C4 ~ E @ ₹50

Coil Voltage Table



COIL VOLTAGE: MASTER TABLE

CR RELAY	COIL VOLTAGE		24V		48V		110V		160-220V		170-240V		220V		230-360V		240V		190-400V		230-420V		260-400V		275-420V		310-400V		380V		380-415V		415V		440V		550V		
	PRODUCT	DC	AC	DC	AC	DC	AC	DC	AC	DC	AC	DC	AC	DC	AC	DC	AC	DC	AC	DC	AC	DC	AC	DC	AC	DC	AC	DC	AC	DC	AC	DC	AC	DC	AC	DC			
FREEDOM	#CR Relay	U	U3	W	W3	A	A3	-	-	-	-	-	-	B	B3	-	-	K	K	-	-	-	-	-	-	-	-	-	-	-	-	-	-	-	-	-	-		
	#CE15A-F, CN14B-F1*	U	U3	W	W3	A	A3	-	-	-	-	-	-	B	B3	-	-	K	K	-	-	-	-	-	-	-	-	-	-	-	-	-	-	-	-	-	-		
	#CE15G-K, CN14G-K2*	U	U3	W	W3	A	A3	-	-	-	-	-	-	B	B3	-	-	K	K	-	-	-	-	-	-	-	-	-	-	-	-	-	-	-	-	-	-	-	
	CCD.05-60	U	-	-	-	-	-	-	-	-	-	-	-	-	-	-	-	-	-	-	-	-	-	-	-	-	-	-	-	-	-	-	-	-	-	-	-	-	
NHD	BCH15KT-LT	U	-	W	-	A	-	-	-	-	-	-	-	B	-	-	-	K	-	-	-	-	-	-	-	-	-	-	-	-	-	-	-	-	-	-	-	-	
	BCH15MT	24	-	48	-	110	110	-	-	-	-	-	-	-	B3	220	-	-	-	-	-	-	-	-	-	-	-	-	-	-	-	-	-	-	-	-	-	-	-
	BCH15NT-PT	24	24	48	48	110	110	-	-	-	-	-	-	-	-	220	-	-	-	-	-	-	-	-	-	-	-	-	-	-	-	-	-	-	-	-	-	-	-
	BCH15MN-PN	24	24	48	48	110	110	-	-	-	-	-	-	-	-	220	-	-	-	-	-	-	-	-	-	-	-	-	-	-	-	-	-	-	-	-	-	-	-
	BCH4040-400	-	-	-	-	A	-	-	-	-	-	-	-	B	-	-	-	-	K	-	-	-	-	-	-	-	-	-	-	-	-	-	-	-	-	-	-	-	-
	MCE15R-S	U	U3	-	-	A	A3	-	-	-	-	-	-	B	-	-	-	K	-	-	-	-	-	-	-	-	-	-	-	-	-	-	-	-	-	-	-	-	-
Shakti	BCH54-64	-	-	-	-	110	110	-	-	-	-	-	220	220	220	-	-	220	-	-	-	-	-	-	-	-	-	-	-	-	-	-	-	-	-	-	-	-	-
	BCH76&78	-	-	-	-	A7	-	-	-	-	-	-	B7	-	-	-	-	-	-	-	-	-	-	-	-	-	-	-	-	-	-	-	-	-	-	-	-	-	
	CP12N, CO0N, CP20N, N0N	U	-	-	-	A	-	-	-	-	-	-	-	-	H	LV	-	-	-	-	-	-	-	-	-	-	-	-	-	-	-	-	-	-	-	-	-	-	
	N01N & N1N	U	-	-	-	A	-	-	-	-	-	-	-	-	H	-	-	-	-	-	-	-	-	-	-	-	-	-	-	-	-	-	-	-	-	-	-	-	
2P	Shakti Star Delta	-	-	-	-	-	-	-	-	-	-	-	-	-	-	-	-	-	-	-	-	-	-	-	-	-	-	-	-	-	-	-	-	-	-	-	-	-	
	CPG - All range	U	-	-	-	A	-	-	-	-	-	-	-	-	H	-	-	-	-	-	-	-	-	-	-	-	-	-	-	-	-	-	-	-	-	-	-	-	
	CPGN 16,20,25	-	-	-	-	-	-	-	-	-	-	-	-	-	-	-	-	-	-	-	-	-	-	-	-	-	-	-	-	-	-	-	-	-	-	-	-	-	
CITATION	C4 & D	U	-	-	-	A	-	-	-	-	-	-	B	-	-	-	-	K	-	-	-	-	-	-	-	-	-	-	-	-	-	-	-	-	-	-	-	-	
	MCE15L-M5	U	-	W	-	A	-	-	-	-	-	-	B	-	-	-	-	K	-	-	-	-	-	-	-	-	-	-	-	-	-	-	-	-	-	-	-	-	
	MCE15N-Q	U	U3	-	-	A	A3	-	-	-	-	-	B	-	-	-	-	K	-	-	-	-	-	-	-	-	-	-	-	-	-	-	-	-	-	-	-	-	

1. For other coil voltages & wide band coil option please contact nearest sales office

*-CN14 is not available in DC coils

#The Interchangeability between AC & DC Coil of CE15 / D15 type contactors is not possible at site. Only Company fitted DC control is available for this range.

§ Please check nearest sales office for delivery period



Citation Overload Relay



- Wide range : From 0.195 A to 600 A
- Built in Single Phasing Protection
- Ambient temperature compensated
- Test button for checking tripping mechanism
- Field convertible auto/manual reset
- Snap on cover
- Special Mechanism ensuring closest protection to motor
- Contactor mounting & separate mounting
- Successfully tested for Type-2 Coordination
- Suitable for almost all makes of Contactors
- Proven and tested

Citation-M Overload Relays (Direct Mounting) with built-in single phase protection

HSN Code : 8536

HSN Code : 8538

Relay Range	Cat. No.	MRP [₹]	Terminal Block for individual mounting	MRP [₹]
0.195 - 0.31	MC305ANA3A	2075	(Incoming) MC305TB1 (Outgoing) MC305TB3	305
0.30 - 0.48	MC305ANA3B			
0.47 - 0.75	MC305ANA3C			
0.72 - 1.14	MC305ANA3D			
1.07 - 1.70	MC305ANA3E			
1.58 - 2.50	MC305ANA3F			
2.40 - 3.80	MC305ANA3G			
3.80 - 6.00	MC305ANA3H			
6.00 - 9.30	MC305ANA3J			
8.90 - 13.50	MC305ANA3K			
13.20 - 20.00	MC305ANA3L	2295	(Incoming) MC305TB2 (Outgoing) MC305TB3	
17.40 - 24.00	MC305ANA3M	2535		
22.00 - 30.00	MC305ANA3N*	3270		
23.00 - 32.00	MC305ANA3P*	3300	(Incoming) MC305TB2 (Outgoing) MC305TB3	
26.00 - 40.00	MC305ANA3Q*	3580		

* Overload relay type "N, P & Q" must be used with terminal block MC305TB3

DIN rail mounting kit with incoming terminal block HSN Code : 8538

Relay Range (A)	Cat. No.	MRP [₹]
A to K	MC305DM1	365
L to N	MC305DM2	375

CT Operated Overload Relays-Individual Mounting HSN Code : 8536

CT Operated Overload Relay



Relay Range (A)	Cat. No.	MRP [₹]
24.4-39.0	CT1MC305ANA3C	6295
37.6-60.0	CT2MC305ANA3C	8125
56.4-90.0	CT3MC305ANA3C	9120
84.6-135.0	CT4MC305ANA3C	9260
112.8-180.0	CT5L1MC305ANA3C	14200
131.6-210.0	CT5MC305ANA3C	14665
188.0-300.0	CT6MC305ANA3C	16805
263.2-420.0	CT7MC305ANA3C	17370
376.0-600.0	CT8MC305ANA3C	20165

WP 2 Pole Overload Relay



- Perfect protection to single phase Motors against overloads
- Ambient temperature compensated

2 Pole Overload Relays (Direct Mounting)

HSN Code : 8536

Relay Range (A)	Cat. No.	MRP [₹]
1.58-2.50	MC307ANA2F	1065
2.40-3.80	MC307ANA2G	
3.80-6.00	MC307ANA2H	
6.00-9.30	MC307ANA2J	
8.90-13.50	MC307ANA2K	
13.20-20.00	MC307ANA2L	1230
17.40-24.00	MC307ANA2M	1315
22.00-30.00	MC307ANA2N	1530
23.00-32.00	MC307ANA2P	1560
28.00-40.00	MC307ANA2Q 	1730

WP Overload Relay



- Designed to withstand wide fluctuations in agricultural applications
- Appropriately sensitive relay for increased pump performance

WP Overload Relays for WP & Oil Starter

HSN Code : 8536

Relay Range (A)	Cat. No. (WP Starter / Oil Starter)	MRP [₹]
6.00 - 9.30	MC307ANA3J / MC307ANA3J-OS	1860
8.90 - 13.50	MC307ANA3K / MC307ANA3K-OS	
13.20 - 20.00	MC307ANA3L / MC307ANA3L-OS	2060
17.40 - 24.00	MC307ANA3M / MC307ANA3M-OS	2280
22.00 - 30.00	MC307ANA3N	2740
23.00 - 32.00	MC307ANA3P (Spare for Oil Starter)	2820

Freedom Overload Relay

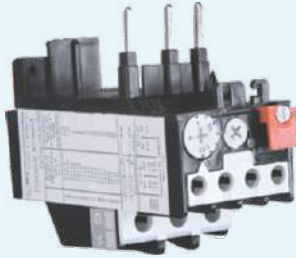

MC318ANA

- Range : From 0.1A to 80A
- IEC:60947-4-1
- Relay class-10A
- Built in Single Phasing Protection
- Ambient temperature compensated
- Test button for checking tripping mechanism
- Field convertible auto manual reset
- Contactor mounting / Individual Mounting



MC318GNA

Freedom Overload Relays

HSN Code : 8536

HSN Code : 8538

Relay Range (A)	Suitable for Direct Mounting	Cat. No.	MRP [₹]	Accessories
0.25-0.40	CE15A to CE15F	MC318ANA3C	2030	Adaptor for Individual mounting Cat. No. C318F1 MRP Rs. 580
0.40-0.63		MC318ANA3D		
0.63-1.00		MC318ANA3E		
1.0-1.40		MC318ANA3F		
1.3-1.80		MC318ANA3G		
1.7-2.4		MC318ANA3H		
2.2-3.1		MC318ANA3J		
2.8-4.0		MC318ANA3K		
3.5-5.0		MC318ANA3L		
4.5-6.5		MC318ANA3M		
6.0-8.5		MC318ANA3N		
7.5-11		MC318ANA3P		
10.0-14.0		MC318ANA3Q		
13.0-19.0	CE15G to CE15K1	MC318ANA3R	2310	Adaptor for Individual mounting Cat No. C318F2 MRP Rs.640
18.0-25.0		MC318ANA3S		
24.0-32.0		MC318ANA3T	3185	
22.0-32.0		MC318GNA3B	3455	
29.0-42.0		MC318GNA3C	3465	
36.0-52.0	MC318GNA3D	4685		
45.0-63.0	MC318GNA3E	5215		
60.0-80.0	MC318GNA3F	6415		

BHARTIA ELECTRONIC OVER CURRENT RELAY

New



- ◆ Range: 0.25A to 60A
- ◆ Protections covered:
Over-load, Under-load, Short Circuit,
Phase Reversal, Phase Unbalance, Locked rotor
Motor Stall, Earth Fault & Contactor Failure
- ◆ Thermal Memory
- ◆ Trip class selection
Class: 05/15/25/10/20/30
- ◆ 4-20mA Output for PLC
- ◆ RTD Temperature Input for trip

- ◆ VFD Compatible
- ◆ Last five fault records
- ◆ Last Three start Stop record
- ◆ Motor Trip Count
- ◆ Password Protection
- ◆ MODBUS Communication
- ◆ Digital Output
- ◆ Remote Start/Stop Function
- ◆ Remote Trip reset Function



BCH
ELECTRIC
LIMITED

HSN Code : 8536

BOCR2.0



- ◆ Range: 0.25A to 60A
- ◆ Protections covered:
Over-load, Under-load, Short Circuit, Phase Reversal, Phase Unbalance, Locked rotor Motor Stall, Earth Fault & Contactor Failure
- ◆ Thermal Memory
- ◆ Trip class selection
Class: 05/15/25/10/20/30
- ◆ VFD Compatible
- ◆ Last five fault records
- ◆ Password Protection
- ◆ Digital Output

Model	Current Range (A)	Cat code	Type	MRP[₹]
◆ BOCR2.0	0.25 - 5	BOCR2.0-05N*	BCH EOCR-2, 0.25-5A with inbuilt Display	On request
		BOCR2.0-05Z*	BCH EOCR-2, 0.25-5A, ZCT , with inbuilt Display	
	2.5-60	BOCR2.0-60N*	BCH EOCR-2, 2.5-60A, with inbuilt Display	
		BOCR2.0-60Z*	BCH EOCR-2, 2.5- 60A,ZCT, with inbuilt Display	
◆ BOCR4.0	0.25 - 5	BOCR4.0-05NN*	BCH EOCR-4, 0.25-5A with extended Display	
		BOCR4.0-05ZN*	BCH EOCR-4, 0.25-5A, ZCT , with Extended Display	
		BOCR4.0-05NM*	BCH EOCR-4, 0.25-5A, with COMM & Extended Display	
		BOCR4.0-05ZM*	BCH EOCR-4, 0.25-5A,ZCT with COM & Extended Display	
	2.5-60	BOCR4.0-60NN*	BCH EOCR-4, 2.5-60A , with Extended Display	
		BOCR4.0-60ZN*	BCH EOCR-4, 2.5-60A, ZCT, with Extended Display	
		BOCR4.0-60NM*	BCH EOCR-4, 2.5-60A, with COM & Extended Display	
		BOCR4.0-60ZM*	BCH EOCR-4, 2.5-60A,ZCT with COM & Extended Display	

* Control Voltage Suffix for BOCR

Control Voltage Table

Voltage Range	Control Supply Code
85-270V AC/DC	A
18-60V DC Only	D

BOCR4.0



- ◆ 4-20mA Output for PLC
- ◆ MODBUS Communication
- ◆ RTD for Temp. Protection
- ◆ Remote Trip reset Function

CTs

HSN Code : 8536

Cat No.	Description	MRP[₹]
3CTB-100-5	BCH EOCR CT 100/5	On request
3CTB-150-5	BCH EOCR CT 150/5	
3CTB-200-5	BCH EOCR CT 200/5	
3CTB-300-5	BCH EOCR CT 300/5	
3CTB-400-5	BCH EOCR CT 400/5	
ZCTB-035	BCH EOCR ZCT with 35mm ID	
ZCTB-050	BCH EOCR ZCT with 50mm ID	
ZCTB-090	BCH EOCR ZCT with 90mm ID	
ZCTB-150	BCH EOCR ZCT with 150mm ID	
ZCTB-200	BCH EOCR ZCT with 200mm ID	

ZCT must be used for ground Fault protection alongwith BOCR

◆ Coming Soon

Electronic Overcurrent Relay



BOCR SS BOCR SSD



- Over Current
- Locked Rotor
- Phase Loss

BOCR - MP35DSD



- Over Current
- Under Current
- Phase Loss
- Phase imbalance
- Phase Reversal
- Under Current
- Stall Motor
- Unbalance Current
- Ground Fault

BOCR 3DE



- Over Current
- Under Current
- Phase Loss
- Phase imbalance
- Phase Reversal
- Locked Rotor

BOCR 3EZ



- Over Current
- Under Current
- Phase Loss
- Phase Unbalance
- Phase Reversal
- Locked Rotor
- Ground Fault

BOCR PMZ



- Over Current
- Under Current
- Phase Loss
- Phase Unbalance
- Phase Reversal
- Locked Rotor
- Ground Fault
- 4-20mA analog output
- RS-485 Comm.

BOCR PFZ



BOCR IFDM/IFDZ



- Over Current
- Under Current
- Phase Loss
- Phase Unbalance
- Phase Reversal
- Locked Rotor
- Ground Fault (in IFDZ model)
- RS-485 communication

Bhartia Electronic Overcurrent Relay

HSN Code : 8536

Model	Current Range	Cat. No.	Type	MRP [₹]
BOCR SS 05	0.5-6A	MP21SS005 ■	Analog model	5605
BOCR SS 30	3.0 -30A	MP21SS030 ■		
BOCR SS 60	5.0-60A	MP21SS060 ■		
BOCR SSD 05	0.5-6A	MP22SSD005 ■	Digital model/ Inbuilt display	10145
BOCR SSD 30	3.0 -30A	MP22SSD030 ■		
BOCR SSD 60	10-60A	MP22SSD060 ■		
BOCR DSD	0.5-60A	MP35DSD-WRUH	Digital model/Inbuilt display/Under Current/Motor Jam	On request
BOCR DRD	0.5-60A	MP35DRD-WRUH	Above Features+Ground Fault	
BOCR DZD	0.5-60A	MP35DZD-WRUH	Above Features+Ground Fault (HFF)	28265
BOCR 3DE 05	0.5-7.0A	MP353DE05D ■H	built-in display, bottom hole	
BOCR 3DE 80	5.0-80A	MP353DE80D ■H		32000
BOCR FDE 05	0.5-7.0A	MP35FDE05D ■H	Flush mounted display #, bottom hole	
BOCR FDE 80	5.0-80A	MP35FDE80D ■H		30765
BOCR 3EZ 05	0.5-7.0A	MP363EZ05A ■H	built-in display, bottom hole, G/F protection	
BOCR 3EZ 80	5.0-80A	MP363EZ80A ■H		34840
BOCR FEZ 05	0.5-7.0A	MP36FEZ05A ■H	Flush mounted display #, bottom hole, G/F protection	
BOCR FEZ 80	5.0-80A	MP36FEZ80A ■H		64815
BOCR PMZ	0.5-100A	MP37PMZWDRD ■H	4-20mZ analog output, built-in display	
BOCR PFZ	0.5-100A	MP37PFZWDRD ■H	4-20mZ analog output, Flush mounted display#	65200
BOCR IFDM	0.5-60A	MP39-IFDM400H ■	RS-485 comm./ Flush mounted display#	On request
BOCR IFDZ	0.5-60A	MP39-IFMZ400H ■	RS-485 comm./Earth fault/ Flush mounted display#	On request

Note : MP32 & MP34 Models are discontinued, please contact nearest sales office for availability till stock lasts

Control Voltage suffix for BOCR

Model no.	Control voltage				
	24-240 VAC/DC	380-440 VAC	100-240 VAC	24 VDC	100-240 VAC/DC
BOCR-SS	S4	W1	-	-	-
BOCR-SSD	S4	W4	-	-	-
BOCR-3DE/FDE	-	-	Z4	-	-
BOCR-3EZ/FEZ	-	-	Z4	-	-
BOCR-PMZ/PFZ	-	-	-	-	U
BOCR-IFDM/IFDZ	-	-	-	-	U4
BOCR-DSD/DRD/DZD	-	-	YES	-	-

CTs

HSN Code : 8536

Cat No.	Description	MRP [₹]
2CT-D1-100-C	2CT EP 100/5	3885
2CT-DH-150-C	2CT EP 150/5	
2CT-D2-200-C	2CT EP 200/5	
2CT-D3-300-C	2CT EP 300/5	4200
2CT-D4-400-C	2CT EP 400/5	5910
3CT-H1-100-C	3CT version 100/5	5975
3CT-HH-150-C	3CT version 150/5	6210
3CT-H2-200-C	3CT version 200/5	6545
3CT-H3-300-C	3CT version 300/5	6950
3CT-H4-400-C	3CT version 400/5	7365
ZCT-035	ZCT version 35mm hole	7085
ZCT-080	ZCT version 80mm hole	9230
ZCT-120	ZCT version 120mm hole	16345

ZCT must be used for ground Fault protection alongwith BOCR

Cable for separate display Models

HSN Code : 8536

Cat No.	For model	Range	MRP [₹]
CABLE-RJ45-003	BOCR-FDEFEZ/PFZ BOCR-IFDM/IFDZ	CABLE-RJ45 3m EOCR-IFD model	2120

Note : Cable must be ordered separately along with the EOCR

MPH range (0.1 to 63A)

- ON/OFF Rotary knob with manual operation
- Clear trip indication with rotary knob
- 1 NO + 1 NC - Front & side mounted Aux. Contact
- Trip indicator for visual discrimination between short circuit & over load tripping
- Undervoltage / Shunt Release
- PAD Lock facility
- Extended Handle
- Mag only version also available
- Plastic Enclosures

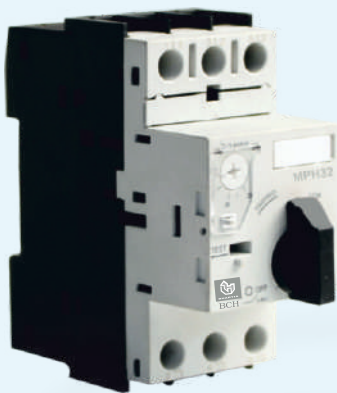

Cat code	Breaking Capacity Icu (kA) 415V, 50Hz	Description	MRP [₹]
(A) Thermal-Magnetic release			
MPH32-0.16	100kA	MPCB 3P TM 0.1- 0.16A	4460
MPH32-0.25	100kA	MPCB 3P TM 0.16-0.25A	4460
MPH32-0.4	100kA	MPCB 3P TM 0.25-0.4A	4460
MPH32-0.63	100kA	MPCB 3P TM 0.4-0.63A	4890
MPH32-1.0	100kA	MPCB 3P TM 0.63-1.0A	4890
MPH32-1.6	100kA	MPCB 3P TM 1.0-1.6A	4985
MPH32-2.5	100kA	MPCB 3P TM 1.6-2.5A	4985
MPH32-4.0	100kA	MPCB 3P TM 2.5-4.0A	5065
MPH32-6.3	100kA	MPCB 3P TM 4.0-6.3A	5205
MPH32-10	100kA	MPCB 3P TM 6.3-10.0A	5270
MPH32-16	50kA	MPCB 3P TM 10.0-16.0A	6110
MPH32-20	50kA	MPCB 3P TM 16.0-20.0A	6965
MPH32-25	50kA	MPCB 3P TM 20.0-25.0A	7460
MPH32-32	50kA	MPCB 3P TM 25.0-32.0A	11715
MPH63-16	50kA	MPCB 3P TM 11.0-16.0A F2	12695
MPH63-20	50kA	MPCB 3P TM 14.0-20.0A F2	12695
MPH63-25	50kA	MPCB 3P TM 18.0-25.0A F2	12695
MPH63-32	50kA	MPCB 3P TM 22.0-32.0A F2	21340
MPH63-40	50kA	MPCB 3P TM 28.0-40.0A F2	21340
MPH63-45	50kA	MPCB 3P TM 36.0-45.0A F2	21340
MPH63-50	50kA	MPCB 3P TM 40.0-50.0A F2	22660
MPH63-63	50kA	MPCB 3P TM 45.0-63.0A F2	22660
(B) With magnetic trip only (no Thermal release)			
MPH32M-0.16	100kA	MPCB 3P Mag only 0.16 A	4355
MPH32M-0.25	100kA	MPCB 3P Mag only 0.25 A	4355
MPH32M-0.4	100kA	MPCB 3P Mag only 0.4 A	4355
MPH32M-0.63	100kA	MPCB 3P Mag only 0.63 A	4595
MPH32M-1.0	100kA	MPCB 3P Mag only 1.0 A	4595
MPH32M-1.6	100kA	MPCB 3P Mag only 1.6 A	4420
MPH32M-2.5	100kA	MPCB 3P Mag only 2.5 A	4420
MPH32M-4.0	100kA	MPCB 3P Mag only 4.0 A	4770
MPH32M-6.3	100kA	MPCB 3P Mag only 6.3 A	4890
MPH32M-10	100kA	MPCB 3P Mag only 10 A	4975
MPH32M-16	50kA	MPCB 3P Mag only 16 A	5520
MPH32M-20	50kA	MPCB 3P Mag only 20 A	5665
MPH32M-25	50kA	MPCB 3P Mag only 25 A	5620
MPH32M-32	50kA	MPCB 3P Mag only 32 A	9815
MPH63M-16	50kA	MPCB 3P Mag only 16 A F2	12210
MPH63M-20	50kA	MPCB 3P Mag only 20 A F2	12210
MPH63M-25	50kA	MPCB 3P Mag only 25 A F2	12210
MPH63M-32	50kA	MPCB 3P Mag only 32 A F2	21090
MPH63M-40	50kA	MPCB 3P Mag only 40 A F2	21090
MPH63M-45	50kA	MPCB 3P Mag only 45 A F2	21090
MPH63M-50	50kA	MPCB 3P Mag only 50 A F2	22365
MPH63M-63	50kA	MPCB 3P Mag only 63 A F2	22365

Accessories MPH range MPCB



Accessories for MPH MPCB

HSN Code : 8538

Cat code	Description	MRP [₹]
MPHF11	Front aux contact 1NO+1 NC MPCB	860
MPHS11	Side aux contact 1NO+1 NC MPCB	1110
MPHT11	MPCB Trip Indicator	1305
MPH024UR	UV Rel. 24V 50HZ MPCB	2120
MPH020UR	UV Rel. 20V 50HZ MPCB	
MPH115UR	UV Rel. 110-115V 50HZ MPCB	
MPH180UR	UV Rel. 180V 50HZ MPCB	
MPH240UR	UV Rel. 230-240V 50HZ MPCB	
MPH380UR	UV Rel. 380V 50HZ MPCB	
MPH415UR	UV Rel. 400-415V 50HZ MPCB	
MPH500UR	UV Rel. 500V 50HZ MPCB	
MPH024SR	Shunt Rel. 20-24V 50/60HZ MPCB	
MPH048SR	Shunt Rel. 40-48V 50/60HZ MPCB	
MPH240SR	Shunt Rel. 200-240V 50/60HZ MPCB	
MPH440SR	Shunt Rel. 365-440V 50/60HZ MPCB	
MPH127SR	Shunt Rel. 100-127V 50/60HZ MPCB	
MPH34	Extd rotary handle for 32A	1745
B31SMA1	Plastic enclosure for MPH32 MPCB	2320
MPH64	Extd Rotary Handle for MPH 63A MPCB	1820
MPHT11F2	LHS Trip Indicator for 63A F2 MPCB	2440



ASA4.0 Series Soft-Starter

24A to 580A, 3 Phase 200V to 525V AC or 380-690V AC
overload upto 600% of the rated current

Protection:

- over / under current
- current imbalance
- Motor Thermistor
- Phase Sequence
- Phase Loss
- Power Loss



Solid State Relays (SSR)

Single Phase SSR's for Heating Applications

SC9 Series 1-Phase ZERO CROSS Without LED

HSN Code : 8536

Cat. No.	MOQ	AC51 Rating	I^2t (A ² S)	Peak Voltage	Operating Voltage	Control Voltage	MRP [₹]
SC941110L	5	12A	72	600V AC	12-280V AC	4-30V DC	2535
SC942110L	5	25A	288	600V AC	12-280V AC	4-30V DC	2965
SC944110L	5	40A	612	600V AC	12-280V AC	4-30V DC	4370

MOQ - Minimum Order Qty.

- Electronic Switching of loads - silent operation
- Life Over 100 million operations
- High Switching Frequency
- Ideal for dusty & corrosive atmosphere
- Impact & Vibration resistant
- Direct compatibility with PLC
- LED Indication as option

SC9 Series 1-Phase ZERO CROSS With LED

HSN Code : 8536

Cat. No.	MOQ	AC51 Rating	I^2t (A ² S)	Peak Voltage	Operating Voltage	Control Voltage	MRP [₹]
SC941160L	5	12A	72	600V AC	12-280V AC	4-30V DC	2555
SC942160L	5	25A	288	600V AC	12-280V AC	4-30V DC	3000
SC944160L	5	40A	612	600V AC	12-280V AC	4-30V DC	4440
SC945160L	5	50A	1500	600V AC	12-280V AC	4-30V DC	7910
SC947160L	5	75A	5000	600V AC	12-280V AC	4-30V DC	8780

MOQ - Minimum Order Qty.



Innovation - Performance-Design

- Removable IP20 flaps.
- Only 29 mm height.
- Designed for all types of loads.
- TMS² Technology with very long life expectancy.
- Control Status LED.
- Very low zero cross level.
- UL/cUL, VDE (EN60950), IEC/EN60947-4-3, CE marking

SO9 Series 1-Phase ZERO CROSS With LED in okpac® Housing IP20 Protection

HSN Code : 8536

Cat. No.	MOQ	AC51 Rating	I^2t (A ² S)	Peak Voltage	Operating Voltage	Control Voltage	MRP [₹]
SO942560*	2	25A	600	600V AC	12-280V AC	7-30V DC	6745
SO963460*	2	35A	1250	1200V AC	24-600V AC	3.5-32V DC	8730
SO945460*	2	50A	2500	600V AC	12-280V AC	3-32V DC	9280
SO965460*	2	50A	2800	1200V AC	24-600V AC	3.5-32V DC	9725
SO967460*	2	90A	7200	1200V AC	24-600V AC	3.5-32V DC	11220

MOQ - Minimum Order Qty.

SU9 Series 1-Phase ZERO CROSS With LED in okpac® Housing IP20 Protection

HSN Code : 8536



Cat. No.	MOQ	AC51 Rating	Peak Voltage	Operating Voltage	Control Voltage	MRP [₹]
SU942460*	44	25A	600V AC	12-280V AC	3-32V DC	6335
SU963460*	44	35A	1200V AC	24-600V AC	3.5-32V DC	7860
SU965460*	44	50A	1200V AC	24-600V AC	3.5-32V DC	8395
SU967460*	44	75A	1200V AC	24-600V AC	3.5-32V DC	10440

SU Range

- Designed for resistive load
- With pluggable connector on input
- IP20 protection with Removable
- For mounting on Heat sink or panel mount
- Over voltage protection on input
- Control Status LED
- Very low zero cross level
- Quick and easy connection

Single Phase SSR's for Capacitor Control Applications SO8 Series 1-Phase With LED in okpac® Housing IP20 Protection

HSN Code : 8536



Cat. No.	MOQ	AC51 Rating	$I^2t(A^2S)$	Peak Voltage	Operating Voltage	Control Voltage	MRP [₹]
SO842074*	2	25A	600	600V AC	12-275V AC	3-32V DC	8205
SO863070*	2	35A	1250	1200V AC	24-510V AC	3.5-32V DC	9045
SO845070*	2	50A	2500	600V AC	12-275V AC	3-32V DC	9700
SO848070*	2	95A	14400	600V AC	12-275V AC	3-32V DC	14595
SO889060*	2	125A	24000	1600V AC	24-600V AC	3.5-32V DC	38730

MOQ - Minimum Order Qty.

Direct Copper Bonding Technology

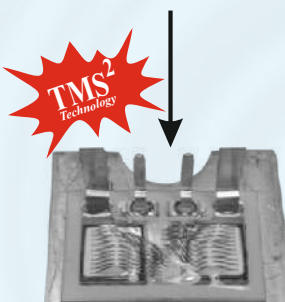

- Fewer joints, fewer layers results in better thermal characteristics
- Extremely low temperature rise ensures long life

Three Phase SSR's

SGT Series 3-Phase With LED (ZERO CROSS) IP20 Protection

HSN Code : 8536



- IP20-RC and VDR Protection
- Designed for all types of load
- Thyristor technology

Cat. No.	MOQ	AC51 Rating	AC53 Rating	$I^2t(A^2S)$	Peak Voltage	Operating	Control Voltage	MRP [₹]
DC CONTROL								
SGT8850200	2	50A	12A	2800	1600VAC	24-640VAC	4-30VDC	40090
SGT8670500	2	75A	16A	7200	1600VAC	24-520VAC	4-30VDC	44095
SGT8690500	2	125A	32A	22000	1600VAC	24-520VAC	4-30VDC	54110
AC/DC CONTROL								
SGT8658500	2	50A	12A	2800	1600VAC	24-520VAC	24-255VAC/DC	42055
SGT8678500	2	75A	16A	7600	1600VAC	24-520VAC	24-255VAC/DC	46200
SGT8698500	2	125A	32A	22000	1600VAC	24-520VAC	24-255VAC/DC	56195

MOQ - Minimum Order Qty.



Common IP20 Protective Cover for SC series SSR.



Heat Sink - 65 mm

- Wide range of Heat sinks offers perfect coordination with all SSRs

Accessories for SSR

HSN Code : 8538

Cat. No.	MOQ	Description	MRP [₹]
SC1K4600	20	IP20 Cover SC*	110
SCHS6 DIN	20	Din Clip	275
SCHS2200	5	Heat Sink 2.2K/W	1435
SCHS1100	5	Heat Sink 1.1 K/W	4365
SCHS0900	5	Heat Sink 0.9 K/W	5455
SCHS0300	5	Heat Sink 0.3K/W	8905

*IP20 Protective Cover for complete SC range
Refer to nearest branch office for heat sink selection

Suggested Heat Sink Rth values (K/W) for load rating at diff. Ambient Temperature

SSR Rating (A)	25°C	35°C	45°C	55°C
12A	2.2	2.2	2.2	1.1
25A	1.1	1.1	0.3	0.3
40A	0.3	0.3	0.3	0.3
50A	0.3	0.3	0.3	0.3
75A	0.3	0.3	0.3	0.3
95A	0.3	0.3	0.3	-
125A	0.3	0.3	-	-

* For Heat Sink Selection of S07 / S08 / S09 / SG4 / SG5 ranges refer to nearest sales office

Note: Apply heat sink compound between SSR base and external heat sink. In case of closely packed units the ambient temperature condition should be considered carefully. For proper protection, short-circuit protection device (SCPD) (having I^2t rating lower than that of SSR I^2t) must be used.

DC Mill Duty Contactor HSN Code : 8536

No. of poles	(A)	Auxilliary Contacts	Cat. No.	MRP [₹]
50 Amperes				
Single pole Normally Open	15A 25A 50A	2NO+2NC 2NO+2NC 2NO+2NC	912x1522 912x2522 912x5022	On request On request 47735
Double pole Normally Open	15A 25A 50A	2NO+2NC 2NO+2NC 2NO+2NC	D912x1522 D912x2522 D912x5022	On request On request 102585
Mechanically Interlocked 2 Nos. SP NO	15A 25A 50A	2NO+2NC 2NO+2NC 2NO+2NC	M912x1522 M912x2522 M912x5022	On request On request 113770
150 Amperes				
Single pole Normally Open	150A	2NO+2NC	914x22	81485
Double pole Normally Open	150A	2NO+2NC	D914x22	174695
Mechanically Interlocked 2 Nos. SP NO	150A	2NO+2NC	M914x22	184355
Single pole Normally Closed	150A	1NO+1NC	924x11	83940
Double Pole Normally Closed	150A	2NO+2NC	D924x22	178065
Single pole Normally Open with Holdout Coil #	150A	1NO+1NC	934x11/#	88340
Single pole Normally Open with AC Blow out Coil	150A	2NO+2NC	974x22	103305
300 Amperes				
Single pole Normally Open	300A	2NO+2NC	915x22	118330
Double pole Normally Open	300A	2NO+2NC	D915x22	251975
Mechanically Interlocked 2 Nos. SP NO	300A	2NO+2NC	M915x22	261970
Single pole Normally Closed	300A	1NO+1NC	925x11	118920
Double Pole Normally Closed	300A	2NO+2NC	D925x22	256865
Single pole Normally Open with Holdout Coil #	300A	1NO+1NC	935x11/#	128395
Single pole Normally Open with AC Blow out Coil	300A	2NO+2NC	975x22	149608



- From 50 A to 600 A
- Conforms to NEMA Standards
- Ready to use mechanically interlocked version
- Normally closed version
- Hold on coil for time delay
- Mechanical life : 20 million operation
- Electrical life : 1 million operation

Unique Arc quenching system with blow out coils for switching heavy duty loads

DC Mill Duty Contactor HSN Code : 8536

No. of poles	(A)	Auxilliary Contacts	Cat. No	MRP [₹]
600 Amperes				
Single pole Normally Open	600A	2NO+2NC	916x22	263680
Double pole Normally Open	600A	2NO+2NC	D916x22	547495
Mechanically Interlocked 2 Nos. SP NO	600A	2NO+2NC	M916x22	556365
Single pole Normally Closed	600A	1NO+1NC	926x11	271035
Single pole Normally Open with Holdout Coil#	600A	1NO+1NC	936x11/#	334990
Single pole Normally Open with AC Blow out Coil	600A	2NO+2NC	976x22	344780

For 934 / 935 / 936 with holdout coil use hold out suffix code from table on page no.10

* For coil voltage refer table on page no.10

* 150, 300 & 600 Amps replace 'x' by 'y' for surface mounting rear connection, 'z' for elevated mounting rear connection

* Add Rs. 5550/- for AC Control

Double Pole DC Mill Duty Contactor HSN Code : 8536

A	Auxilliary Contacts	Cat. No.	Unit Price [₹]
150A	2NO+2NC	954x22	249350
300A	2NO+2NC	955x22	290930

DC Mill Duty Contactors - Spares

HSN Code : 8538

Description	Qty. Reqd.	50A		150A		300A		600A	
		Cat. No.	MRP [₹]	Cat. No.	MRP [₹]	Cat. No.	MRP [₹]	Cat. No.	MRP [₹]
DC Arc Chute Assy. Consisting of a. LH Arc Shield b. RH Arc Shield c. DC Blow Out Arc Horn d. DC Blow Out Arc Piece e. DC Blow Out Spacer Assy. f. Polarity Wire g. Latch Strips (Top & Bottom) h. Hardware for Polarity Wire & Latch	1 Set	9C9J101*	23665	9C9P101	40525	9C9T101	58740	9C9V101	127835
AC Arc Chute Assy. Consisting of a. LH Arc Shield b. RH Arc Shield c. AC Blow Out Pole Piece d. AC Blow Out Spacer Assy. e. Polarity Wire f. Latch Strips (Top & Bottom) g. Hardware for Polarity Wire & Latch	1Set	-	-	9C9P102	On request	9C9T102	On request	9C9V102	On request
Fixed & Moving Contacts	1 Set	9C9J105	5380	9C9P105	7405	9C9T105	12000	9C9V105	32615
Contact Lever with Braid (for Single Pole)	1 No.	9C9J106	6545	9C9P106	10665	9C9T106	14110	9C9V106	24465
Contact Lever with Braid (for Double Pole) [†]	1 No.	9C9J106	6545	9C9P106	10665	9C9T106	14110	9C9V103	24465
Set of Armature Spares Consisting of a. Adjusting Pin b. Contact lever spring c. Contact lever spring pin with circlip d. Armature hinge pin e. Armature Securing pin	1 Set	9C9J107	2240	9C9P107	3100	9C9T107	4460	9C9V107	6475
Set of Armature Spares for 924, 925, 926 Consisting of a. Adjusting Pin b. Contact lever spring c. Contact lever spring pin with circlip d. Armature hinge pin e. Armature Securing pin f. Armature spring g. Spring retaining washer	1 Set	-	-	9C9P108	3775	9C9T108	6650	9C9V108	8020
Set of Armature Spares for 934/935/936 Consisting of a. Adjusting pin b. Contact lever spring c. Contact lever hinge pin d. Armature hinge pin e. Armature securing pin f. Armature spring g. Spring retaining washer h. Adjusting screw	1 Set	-	-	9C9P109	4510	9C9T109	6650	9C9V109	8515
Terminal Block	1	9C9J110	3020	9C9P110	3945	9C9T110	5520	9C9V110	6890
No Volt Coil for 912, 914, 915, 916, 934, 935 & 936 **Suffix voltage code	1	9C9J111■	12080	9C9P111■	18465	9C9T111■	24295	9C9V111■	41845
No Volt Coil for 924, 925, 926 **Suffix voltage code	1	-	-	9C9P112■	24295	9C9T112■	37725	9C9V112■	60935
Coil clamp for 914 & 934	1	-	-	9C9P118	430	-	-	-	-
Coil clamp for 924, 915, 935, 916 & 936	1	-	-	9C9P118	430	9C9T118	430	9C9V118	On request

- Suffix coil voltage code from table on page 10
- Please add Rs. 5385 for AC control

- * Only item a to e is supplied in this set
- † For two Poles, need to order for 2 Nos.

DC Mill Duty Contactors - Spares & Accessories HSN Code : 8538

Description	Cat. No.	MRP [₹]
1NO+1NC Auxilliary Contact Block	AC10E11	9430
2NO Auxilliary Contact Block	AC10E20	9430
2NC Auxilliary Contact Block	AC10E02	9430
Single unit driver with mounting plate (50A)	9C9J115	1500
Double unit driver with mounting plate (50A)	9C9J116	2165
Single unit driver with mounting plate (150-600A)	9C9P116	1625
Double unit driver with mounting plate (150-600A)	9C9P117	2375
Hold out coil for 934, 935 & 936	9C9P113-#	29315
Condenser 50 + 50uF for 934, 935 & 936	9C9P114	1625
Mechanical interlock for 150/300/600A	AC10M4/M8/M12	10510
Rectifier 110/240 V	SP30R	5550

Suffix hold out coil code from table

Hold Out Coil Suffix table - 934/935/936

Hold out coil type	Voltage	Suffix code
494-2	100/125	2
494-7	400/450	7
492-12	100/125	12
494-43	200/250 & 400/550	43



- Magnetic Operated Overload relay for heavy duty applications
- From 1.5A to 600A
- Instantaneous and Time delay tripping
- Manual and automatic resetting
- 1NO + 1NC Contacts

DC Magnetic Overload Relays *

HSN Code : 8536

Cat. No.	Coil No.	Continuous Rating	Range Amps	MRP [₹]
B3A23	159-10	2.8	1.5 to 3.5	28600
B3B23	159-5	3.9	3 to 7	
B3C23	159-4	5.4	5 to 13	
B3E23	159-3	10.9	8 to 24	
B3F23	159-2	16.9	10 to 30	
B3G23	159-1	21.9	20 to 40	
B3H23	159-8	34.9	25 to 65	
B3J23	159-6	50.0	35 to 75	33510
B3K23	179-39	69.0	40 to 120	
B3L23	179-38	109.0	70 to 190	
B3M23	179-37	179.0	100 to 300	36535
B3N23	179-36	299.0	200 to 600	
B3Y23	179-36.2	199.0	200 to 600	44440
B3P23		549.0	300 to 900	
B3R23		500.0	500 to 1500	

* With 1NO + 1NC Contacts

Coil Voltage table - DC Mill Duty Contactor

		24V	48V	55V	110V	220V	240V	250V	
DC CONTACTOR	PRODUCT	DC	DC	DC	AC	DC	DC	AC	F1
	912X	U1	-	Q1	A1R	A1	B1	K1R	F1
	914;934X	U1	W1	Q1	A1R	A1	B1	K1R	F1
	935X;924;915	U1	W1	Q1	A1R	A1	B1	K1R	F1
	925	-	-	-	-	A1	B1	K1R	F1
	916&936	U1	W1	Q1	A1R	A1	B1	K1R	F1
	D912-D916	-	W1	-	A1R	A1	B1	K1R	F1

1. For other coil voltages, please contact nearest sales office
2. AC control is not available for 934, 935, 936 versions.
3. For ordering spare coils for D912, D914, D915 and D916 Contactors, please order coils with 50% voltage rating as that of control voltage. Example to order coils for D914 X 22B1 (which is a 220V DC DP Contactor), please order spare coils with 110V DC rating.



Range

- Non illuminated and illuminated
- Flush
- Extended
- Mushroom head
- Lever and key type selector switch
- Indicators-Direct/Resistor/Transformer type
- Conforms to EN/IEC-60947-5/IS-13947-5

Features

- Protection degree - IP65
- Rugged construction
- Ideal for motor control centers and control panels
- Proven time tested design

Oil Tight Push Button & Indicating Lights - 'Type T' E 30.5 mm

HSN Code : 8536

Type	Description	Cat. No.	MRP [₹]	HSN Code	Lot Size
Actuator	Standard flush Button				
	Red	TSFB-R	355	8536	20
	Green	TSFB-G			
	Black	TSFB-B			
	Yellow	TSFB-Y			
	Blue	TSFB-BL			
	Orange	TSFB-O			
	White	TSFB-W			
	Long Button				
	Red	TLB-R	380	8536	10
Green	TLB-G				
Black	TLB-B				
Yellow	TLB-Y				
Blue	TLB-BL				
Orange	TLB-O				
White	TLB-W				
Mushroom Head					
-Spring return Red	TMH-R	445	8536	10	
-Spring return Green	TMH-G	445			
-Turn to release Red	TMHL-R	525			
-Turn to release Green	TMHL-G	525			
Selector Actuator					
-2 or 3 position	TSSA ***	880	8536	10	
Cylindrical Lock					
-2 or 3 positions	TCL ***	1270	8536	10	
Station	Start/Stop Pushbutton	E20EA	1315	8536	1
Contact Block	1NO +1NC	050N1	485	8536	20
	2NO	050N2			
	2NC	050N3			
Aluminium Diecast Enclosure	One button	TEN-1	1670	8536	1
	Two buttons	TEN-2	1915		
	Three buttons	TEN-3	2595		
				HSN Code : 8538	
Accessories	Wrench for retaining ring	TWN	440	8538	1
	Plug for hole	TPL	205		
	Legend plate	050L^	95		

Note: * Position-2 or 3 • Function M-maintained, S-Springreturn ■ Cam code 1/2/3 ^ Suffix Legend Code

Oil Tight Indicating Light - E 30.5mm

HSN Code : 8536

Description	Application	Cat. No.	List Price [₹]	HSN Code	Lot Size
(Without lens) Direct type	AC & DC	TILD•10	625	8536	1
Transformer type	AC	TILT•10	790	8536	1
HSN Code : 8538					
Polycarbonate Lens	-	LENS*	105	8538	10
Spare Bulb	AC & DC	SP61L#	115	8538	1

* Lens available in colours given below # Suffix voltage code lamp

Voltage Code (Direct type lamps)

Volts	6	12	24	48	110	220	240	415
Code	*	*	U	*	A	B	K	M

Voltage Code (Transformer type lamps)

Volts	110/6	110/24	220/6	240/24	415/6
Code	A	*	*	K/U	*

* Available on request

Suffix Colour Code - 30.5 mm

Colour	Suffix	Colour	Suffix
Red	1P	Yellow	5P
Green	2P	White	6P
Blue	3P	Clear	7P
Amber	4P		

Accessories for indicating light - E 30.5mm

HSN Code : 8538

Description	Cat. No.	List Price [₹]	HSN Code	Lot Size
Signal lamp transformer	TR ■	455	8538	10



Legend Plate - Suffix Code for E30 & 22.5

Inscription	Start	Stop	Inch	Forward	Reverse	UP	Down	Slow	Fast	Raise	Left	Motor Run	Motor Stop	Overload Tripped	Overload Reset	Power On
Suffix code Type T (30.5mm)	1	2	3	4	5	6	7	9	10	11	-	-	-	-	-	-
Suffix code E22 (22.5mm)	34	35	14	07	41	40	04	33	06	-	18	22	23	30	31	32

Inscription	Stop Reset	Test	Trip	Lower	Off	On	Jog	Emergency Stop	Reset	High	Run	Close	Open	Blank	On-Off
Suffix code Type T (30.5mm)	-	-	-	12	13	14	15	16	17	19	20	21	22	23	28
Suffix code E22 (22.5mm)	36	37	38	-	24	26	-	05	-	12	-	03	27	01	-

New

Control & Signalling Devices 22.5mm



Control & Signalling Devices 22.5 mm – BML Metal Series (Non- illuminated)

HSN Code : 8536

Product	Description	Colour	Cat. No.	Unit MRP [₹]	Lot Size
	Flush Actuator	Red	● BML22FA - R	150	30
		Green	● BML22FA - G	150	
		Yellow	● BML22FA - Y	150	
		Blue	● BML22FA - BL	150	
		Black	● BML22FA - BK	150	
		White	● BML22FA - W	150	
	Projecting Actuator	Red	● BML22PA - R	165	15
		Green	● BML22PA - G	165	
		Yellow	● BML22PA - Y	165	
		Blue	● BML22PA - B	165	
		Black	● BML22PA - BL	165	
		White	● BML22PA - W	165	
	Mushroom Actuator (Momentary) Head – ϕ 40mm	Red	● BML22MM4 - R	215	20
		Green	● BML22MM4 - G	215	
		Yellow	● BML22MM4 - Y	215	
		Blue	● BML22MM4 - BL	215	
		Black	● BML22MM4 - BK	215	
		White	● BML22MM4 - W	215	
	Mushroom Actuator (Twist to Release) Head – ϕ 40mm	Red	● BML22MT4 - R	300	20
		Black	● BML22MT4 - BK	300	
	Mushroom Actuator (Key to Release) Head – ϕ 40mm	Red	● BML22MK4 - R	670	20
	Mushroom Actuator (Momentary) Head – ϕ 60mm	Red	● BML22MM6 - R	355	6
		Green	● BML22MM6 - G	355	
		Yellow	● BML22MM6 - Y	355	
		Blue	● BML22MM6 - BL	355	
		Black	● BML22MM6 - BK	355	
		White	● BML22MM6 - W	355	
	Mushroom Actuator (Twist to Release) Head – ϕ 60mm	Red	● BML22MT6 - R	385	6
		Black	● BML22MT6 - BK	385	





Control & Signalling Devices 22.5mm





Control & Signalling Devices 22.5 mm – BML Metal Series (Non- illuminated)

HSN Code : 8536

Product	Description	Colour		Cat. No.	Unit MRP [₹]	Lot Size
	Selector Knob Actuator					
	2 Position - Maintained	Black	●	BML22SM2P - BK	420	15
	3 Position – Maintained (both side)	Black	●	BML22SM3P - BK	420	
	2 Position Spring Return	Black	●	BML22SS2P - BK	460	
	3 Position Spring Return (Both Side)	Black	●	BML22SS3P - BK	470	
	Selector Key Actuator					
	2 Position - Maintained	Black	●	BML22SK2P - BK	585	15
	3 Position - Maintained (both side)	Black	●	BML22SK3P - BK	610	
	Twin Actuator (Spring Return with Green Knob "I" marked & Red Knob "O" marked)	Green & Red	● & ●	BML22TA- RG	260	15

Control & Signalling Devices 22.5 mm - BML Metal Series (illuminated)

	LED Luminous Twin Actuator AC/DC : 12V, 24V, 48V, 60V DC :110V, 220V AC : 110V, 240V, 440V	Red & Green Marked (I/O) & Amber LED	●	BML22LTA□- A	495	10
	LED Luminous Actuator AC/DC: 12V, 24V, 48V, 60V DC:110V, 220V AC: 110V, 240V, 440V	Red	●	BML22LA□- R	430	15
		Green	●	BML22LA□- G	430	
		Yellow	●	BML22LA□- Y	430	
		Clear	●	BML22LA□- C	430	
		Amber	●	BML22LA□- A	430	
		White	●	BML22LA□- W	690	
		Blue	●	BML22LA□- BL	690	

□ : Please mention voltage code from Table 2 (page no.52)



Control & Signalling Devices 22.5mm



Control & Signalling Devices 22.5 mm – BML Metal Series (illuminated)

HSN Code : 8536

Product	Description	Colour	Cat. No.	Unit MRP [₹]	Lot Size
	LED Luminous 2 Position Selector Actuator (Maintained) AC/DC: 12V, 24V, 48V, 60V DC:110V, 220V AC: 110V, 240V, 440V	Red	● BML22LSM2□-R	655	15
		Green	● BML22LSM2□-G	655	
		Yellow	● BML22LSM2□-Y	655	
		Clear	● BML22LSM2□-C	655	
		Amber	● BML22LSM2□-A	655	
		White	● BML22LSM2□-W	915	
		Blue	● BML22LSM2□-BL	915	
	LED Luminous 3 Position Selector Actuator (Maintained) AC/DC: 12V, 24V, 48V, 60V DC:110V, 220V AC: 110V, 240V, 440V	Red	● BML22LSM3□-R	655	15
		Green	● BML22LSM3□-G	655	
		Yellow	● BML22LSM3□-Y	655	
		Clear	● BML22LSM3□-C	655	
		Amber	● BML22LSM3□-A	655	
		White	● BML22LSM3□-W	915	
		Blue	● BML22LSM3□-BL	915	

Control & Signalling Devices 22mm – BIL/BML LED Indicating Light

	LED Indicating Light - Standard (Barrel Type) AC/DC : 12V, 24V, 48V, 60V DC :110V, 220V AC : 110V, 240V, 440V	Red	● BIL22BRS□-R	220	30
		Green	● BIL22BRS□-G	220	
		Yellow	● BIL22BRS□-Y	220	
		Clear	● BIL22BRS□-C	220	
		Amber	● BIL22BRS□-A	220	
		White	● BIL22BRS□-W	395	
		Blue	● BIL22BRS□-BL	395	
	LED Indicating Light - with LVGP (Barrel Type) AC/DC : 12V, 24V, 48V, 60V DC :110V, 220V AC : 110V, 240V, 440V	Red	● BIL22BRP□-R	265	30
		Green	● BIL22BRP□-G	265	
		Yellow	● BIL22BRP□-Y	265	
		Clear	● BIL22BRP□-C	265	
		Amber	● BIL22BRP□-A	265	
		White	● BIL22BRP□-W	440	
		Blue	● BIL22BRP□-BL	440	
	LED Indicating Light - Universal Voltage (Barrel Type) 12-230V AC/DC	Red	● BIL22BRUH4-R	335	30
		Green	● BIL22BRUH4-G	335	
		Yellow	● BIL22BRUH4-Y	335	
		Clear	● BIL22BRUH4-C	335	
		Amber	● BIL22BRUH4-A	335	
		White	● BIL22BRUH4-W	515	
		Blue	● BIL22BRUH4-BL	515	
	Pilot LED Indicating Light AC/DC : 12V, 24V, 48V, 60V DC :110V, 220V AC : 110V, 240V, 440V	Red	● BML22PL□-R	385	15
		Green	● BML22PL□-G	385	
		Yellow	● BML22PL□-Y	385	
		Clear	● BML22PL□-C	385	
		Amber	● BML22PL□-A	385	
		White	● BML22PL□-W	645	
		Blue	● BML22PL□-BL	645	

□ : Please mention voltage code from Table 2



Control & Signalling Devices 22.5mm



Control & Signalling Devices 22.5 mm - Accessories for BML Series

HSN Code : 8536

Product	Description	Type	Cat. No.	Unit MRP [₹]	Lot Size
	Contact Element 	1 NO	BML22CB10	110	50
		1 NC	BML22CB01	110	
	Legend Plate Metal	Aluminium	BML22LPM-□	35	30
	Legend Plate Plastic Yellow Colour	Emergency / Stop	BML22LPP - 23	35	30
	Hole Closer	Plastic	BML22HC	70	50
	Rubber Boot for Flush Actuator	Transparent	BML22RB	80	20
	Rubber boot for Illuminated Push Button	Clear	BML22LRB	85	20

□: Please mention legend plate code from Table 1

Suffix Code Table

legend Plate	Code	legend Plate	Code
Start	1	OFF	12
Stop	2	Right	13
Forward	3	Left	14
Reverse	4	TRIP	15
UP	5	Local	16
DOWN	6	Remote	17
Open	7	Test	18
Close	8	Run	19
Auto	9	R Phase	20
Reset	10	Y Phase	21
ON	11	B Phase	22

Voltage	Code
12V AC/DC	S4
24V AC/DC	U4
48V AC/DC	W4
60V AC/DC	Y4
110V DC	E1
220V DC	H1
110V AC	E
240V AC	H
415V AC	M

Note: **FLEXI22** Push Button - 22.5mm are also available on request.

Punched Grid Resistors

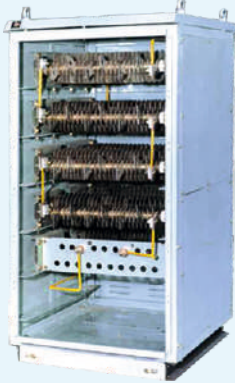

Applications:

- Speed Control Resistors
- Starting Resistors for AC and DC Motors
- Dynamic Braking Resistors
- Neutral Grounding Resistors (upto 11KV)

Features

- Special Chromium Steel Alloy (AISI406) for :
 - a) Higher resistivity (approx 70% higher than others)
This results in overall light and compact unit
 - b) Low temperature coefficient (approx 72% lower than others)
This means negligible change in resistance values despite grid temperature variations (very important parameter in applications like crane controls)
 - c) Unbreakable and corrosion free Grids . Suitable for extreme vibration conditions
 - d) Drawout type of banks for ease of removal while replacements
 - e) Three rod construction for higher range resistance grid for improved mechanical strength
 - f) Individual grids are T.I.G. welded for consistent current path
 - g) Unique design using staggered grid pattern ensuring maximum air circulation
 - h) Terminal designed for 2 types of conductors ensuring flexibility

We also manufacture NGRs & DBRs

GST to be charged extra on PGR Prices

PGRs are 10 minutes rated.

Temp. rise : 375 deg over ambient

Dimensions in mm (WxHxD) : 673x152x250 HSN Code - 8533

Type	Resistance Per Bank	Continuous Rating	LP
	Ohms	Amps	[₹]
WL10	0.1	225	27795
WL12	0.125	200	24590
WL16	0.16	180	28410
WL20	0.2	150	29005
WL25	0.25	134	25610
WL32	0.32	118	22675
WL40	0.4	113	26225
WL50	0.5	100	22155
WL62	0.62	84	28590
WL80	0.8	75	25910
WL100	1	67	24085
WL125	1.25	64	26810
WL160	1.6	57	23135
WL200	2	54	25755
WL250	2.5	48	22735
WL320	3.2	43	19920
WL400	4	40	27735
WL500	5	35	20125
WL625	6.25	33	22985
WL800	8	29	21445
WL1200	12	21	22985
WL1600	16	19	22300

Dimensions in mm (WxHxD) : 800x152x250 HSN Code - 8533

Type	Resistance Per Bank	Continuous Rating	LP
	Ohms	Amps	[₹]
WLL20(M)-1	0.325	150	45095
WLL25(M)-1	0.54	134	41455
WLL32(M)-1	0.68	118	36565
WLL50(M)-1	0.864	100	30985

Industrial Brakes

- AC Solenoid & Brakes
- DC Brakes

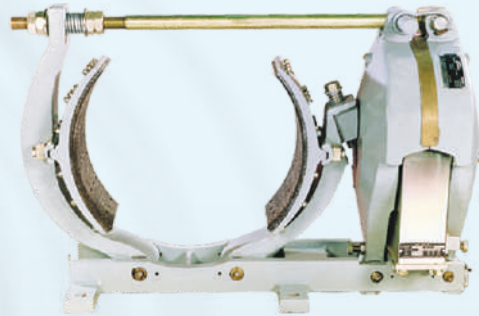
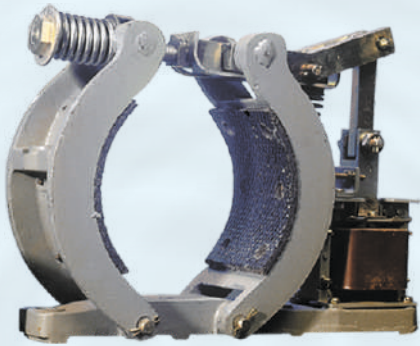



AC Solenoid - Pull Type

GST to be charged extra

HSN Code : 8505

Type	Suitable for	Stroke Length mm	Max. Pull at rated voltage Kg.	Cat. No.	List Price [₹]
B	S-42	25.0	1.25	SLB■	6365
D	S-51, S-71 S-52, S-72	31.4	6.75	SLD■ SLD2■	9385
E	S-250	40	10	SPSLEM SPSLEB	20410

* The standard coil voltages are 110, 220 & 415 V 50 Hz. AC

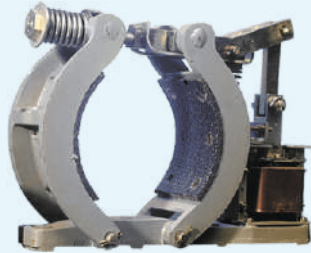

AC Solenoid Brake - Type S

GST to be charged extra

HSN Code : 8505

Type of Brake	Wheel dia.		Max. Torque		Duty	Brake		Drum	
	Inch	mm	Lb. ft.	Nm		Cat No.	List Price [₹]	Cat No.	List Price [₹]
S-4	4	101.6	10	13.6	Continuous	S-42■	14985	AC50D4	2440
S-5	5.5	139.7	25	34.0	Continuous Intermittent	S-51■	21430	AC50D5	3365
			35	48.0		S-52■			
S-7	7	177.8	50	68.0	Continuous Intermittent	S-71■	24505	AC50D7	4085
			75	102.0		S-72■			
S-250	9.84	250	109	147.0	Continuous	S-2501M	52720	AC50D25	8250

- The standard coils are 110, 220 & 415 V 50 Hz. AC

■ To complete Cat. No. suffix voltage code given below

- Brake drums are of standard specification

Range

- Solenoids:
 - Type : SLB - 25 mm stroke length
 - Type : SLD - 31.4 mm stroke length
- AC Brakes
 - 4" Dia
 - 5.5" Dia
 - 7" Dia
- Drums

Features

- Class F insulation of the coil
- Continuous & Intermittent duty
- Long life & ease of maintenance
- Ideally suited for applications such as :
 - Cranes
 - Hoists
 - Machines
 - Valves
 - Conveyers

AC Solenoid Brakes - Voltage Codes

Coil Voltage	110	220	415
AC	A	B	M

Spares For AC Solenoid Brake

GST to be charged extra

HSN Code : 8505

Description	Brake Size : 4"		Brake Size : 5.5"		Brake Size : 7.0"		Brake Size : 250mm	
	Cat. No.	List Price [₹]	Cat. No.	List Price [₹]	Cat. No.	List Price [₹]	Cat. No.	List Price [₹]
Brake lining	SP50L1	1790	SP50L2	2655	SP50L3	3550	SP50L4	6945
Brake shoe Assembly*	SP50SA1	5200	SP50SA2	6705	SP50SA3	11050	SP50SA4	22255
Brake Coil -Continuous -Intermittent	SP50MC01■	3075	SP50MC21■ SP50MC22■	6100	SP50MC21■ SP50MC22■	6100	SP50MC31■	16110

* Brake shoe assembly is with lining.

■ To Complete Cat. No. suffix voltage code is given in table, above.

***GST to be charged extra on all AC Brakes & Brake Spares**

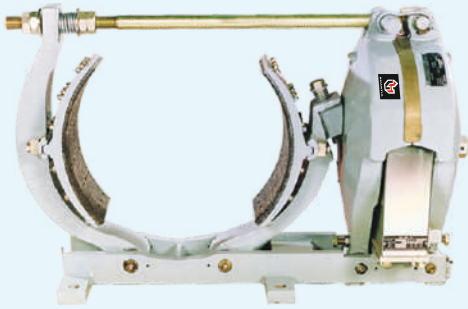

- Shunt and Series type versions in sizes :
8 Inch to 30 Inch
160 mm to 800 mm
- Conforms to NEMA and AISE Standards
- Fail safe operation
- Unique design for maximum torque and minimum shoe wear
Brakes equivalent to Russian 'TK Π' design also available
- Resistance & rectifier Panel available with option of 'Fuse' or 'MCB' protection



Optional Features

- Limit Switch Attachment
- Manual Release
- Residual magnetism adjustment



GST to be charged extra

HSN Code : 8505

DC Electromagnetic Brakes

Shunt Type Torque				Resistance & Rectifier Panel (with fuse protection) ⁺			
Drum Size	Cat No.	Torque	List Price [₹]	Single Brake		2 Brakes Simult. Operation	
		KG-M		Cat No.	List Price [₹]	Cat No.	List Price [₹]
150mm	SMH150	8	74710	CACS1*MAE	78205	CACS2*MAE	108625
160mm	SMH160						
8"/200mm	SMH8	13.8	87945	CACA1*MAE	87180	CACJ2*MAE	112965
	SMH200	13.8					
10"/250mm	SMH10	27.7	107956	CACB1*MAE	92500	CACK2*MAE	127155
	SMH250	27.7					
13"/300mm	SMH13	76.0	176735	CACC1*MAE	99740	CACL2*MAE	148070
	SMH300	76.0					
16"/400mm	SMH16	138.8	284475	CACD1*MAE	114845	CACM2*MAE	160905
	SMH400	138.8					
19"/500mm	SMH19	277.0	458605	CACE1*MAE	138865	CACN2*MAE	203290
	SMH500	277.0					
23"/600mm	SMH23	555.0	725810	CACF1*MAE	179045	CACP2*MAE	257190
	SMH600	555.0					
30"/700mm	SMH30	1242.0	1616290	CACG1*MAE	706800	-	-
	SMH700	1242.0					
800mm	SMH800	1242.0	1751165	CACG1*MAE	706800	-	-

* For control supply i.e. A=110 V, B=220 V, K =240V and M=415 V AC
 1. DC Electromagnetic Brakes are suitable to operate on:
 For AC Power - Resistance & Rectifier Panel
 For DC Power - Series Resistance Box

+ For Panel with MCB protection use the suffix '- MCB'
 eg. For 200mm single operation brake panel with MCB protection,
 Cat code will be CACA1*MAE-MCB

- All Brakes are Supplied for Continuous Duty
 - Resistance & Rectifier Panel is supplied without transformer.
 - Control Transformer (Optional) can be supplied at extra cost.
 Please add Rs. 9730/- per unit with the LP of Resistance & Rectifier Panel. Please add 'TR' with respective panel cat. ref. to obtain final cat. Code of such panel with control transformer.

***GST to be charged extra on all DC Brakes, Brake Spares, Resistance & Rectifier Panel & Resistance Boxes**



Resistance Boxes for DC Electromagnetic Brakes

GST to be charged extra

HSN Code : 8505

Suitable for Shunt Type		Permanent Series Resistance Box for 230 V DC Supply For Single Brake		Permanent Series Resistance Box for 230 V AC Supply For Single Brake		Permanent Economy Resistance Box for 415 V AC Supply For Single Brake		Permanent Economy Resistance Box for 415 V AC Supply For Double Brake	
Cat No.	Torque KGM	Cat No.	List Price [₹]	Cat No.	List Price [₹]	Cat No.	List Price [₹]	Cat No.	List Price [₹]
SMH150 / SMH160	8	CDCS101D	10140	CARS10KE	9275	CARS10ME	18715	CARS20ME	On request
SMH8 / SMH200	13.8	CDCA101D CDIA101D*	10535	CARA10KE	9590	CARA10ME	18715	CARA20ME	On request
SMH10 / SMH250	27.7	CDCB101D CDIB101D*	12490	CARB10KE	11040	CARB10ME	18715	CARB20ME	On request
SMH13 / SMH300	76.0	CDCC101D CDIC101D*	14415	CARC10KE	13085	CARC10ME	21415	CARC20ME	29260
SMH16 / SMH400	138.8	CDCD101D CDID101D*	15425	CARD10KE	14065	CARD10ME	24895	CARD20ME	30740
SMH19 / SMH500	277.0	CDCE101D CDIE101D*	16520	CARE10KE	15075	CARE10ME	27630	CARE20ME	On request
SMH23 / SMH600	555.0	CDCF101D CDIF101D*	18810	CARF10KE	16930	CARF10ME	29690	CARF20ME	On request
SMH30 / SMH700	1242.0	CDCG101D CDIG101D*	On request	-	-	CARG10ME	51225	-	-
SMH800	1242.0	CDIG101D*	On request	-	-	CARG10ME	51225	-	-

1. DC Electromagnetic Brakes are suitable to operate on:
 For AC Power - Resistance & Rectifier Panel
 For DC Power - Series Resistance Box
- All Brakes are Supplied for Continuous Duty
 - * These cat. references are meant for intermittent duty

***GST to be charged extra on all DC Brakes, Brake Spares, Resistance & Rectifier Panel & Resistance Boxes.**

GST to be charged extra

Series Type - DC Electromagnetic Brakes

HSN Code : 8505

Brake Size	Motor Frame No. (Max.)	Half Hour Rating			One Hour Rating			List Price [₹]
		Torque KGM	Max. FLC (A)	Cat. No.	Torque KGM	Max. FLC (A)	Cat. No.	
8"/200mm	402,802A	13.8	29	SME8H1 SME200H1	8.97	21	SME801 SME20001	181175
	403, 602, 802B		44	SME8H2 SME200H2		31	SME802 SME20002	On request
10"/250mm	404,603,802C,	27.7	57	SME10H1 SME250H1	18.0	40	SME1001 SME25001	258480
	406,604,803		77	SME10H2 SME250H2		57	SME1002 SME25002	On request
13"/300mm	408,606,804	76.0	126	SME13H1 SME300H1	49.4	95	SME1301 SME30001	350195
	410,608,806		176	SME13H2 SME300H2		132	SME1302 SME30002	On request
16"/400mm	412,610,808	138.8	245	SME16H1 SME400H1	90.2	185	SME1601 SME40001	548045
19"/500mm	414,612,810	277.0	368	SME19H1 SME500H1	180.0	272	SME1901 SME50001	841940
	416,614,812		500	SME19H2 SME500H2		360	SME1902 SME50002	On request
23"/600mm	418,616,814	555.0	740	SME23H1 SME600H1	361.0	540	SME2301 SME60001	1362150
	618,816		960	SME23H2 SME600H2		730	SME2302 SME60002	On request















- During ordering, besides brake drum dia, please confirm duty rating, current rating & motor frame Nos.
- Above current ratings are for 230 V DC Series Motors.
- To convert KGM to LB.FT. multiply by 7.25

***GST to be charged extra on all DC Brakes, Brake Spares, Resistance & Rectifier Panel & Resistance Boxes.**

GST to be charged extra

Series & Accessories - DC Electromagnetic Brakes

HSN Code : 8505

Description	150/160mm		8"/200mm		10"/250mm		13"/300mm	
	Cat No.	List Price [₹]	Cat No.	List Price [₹]	Cat No.	List Price [₹]	Cat No.	List Price [₹]
 Coil Shunt	9GDS01	55710	9GDA01	65965	9GDB01	79730	9GDC01	126570
 Coil Series for inch for mm	-	-	9GDA02/ 9GDA03	140525	9GDB02/ 9GDB03	220260	9GDC02/ 9GDC03	284845
 Torque Adj. Screw Assembly	9GDS04	5080	9GDA04	5310	9GDB04	5315	9GDC04	9235
 Torque Spring	9GDS05	13840	9GDA05	14450	9GDB05	17070	9GDC05	27630
 Wedge Assembly with Bolt, Spring and Washers for inch/mm	9GDS20/ 9GDS22	1980	9GDA20/ 9GDA22	2265	9GDB20/ 9GDB22	2630	9GDC20/ 9GDC22	4010
 Pin set for Lever & Armature Consisting of a) Pin Lever 2 Nos. b) Pin armature 2 Nos.	9GDS06	6980	9GDA06	7325	9GDB06	7325	9GDC06 9GDC06-2#	9235
 Coller Set of Lever & Armature Consisting of a) Coller Lever 4 Nos. a) Coller Armature 4 Nos.	9GDS07	6980	9GDA07	7325	9GDB07	7325	9GDC07	8780
 Bush Set for Lever & Armature Consisting of a) Bush Lever 4 Nos. a) Bush Armature 4 Nos.	9GDS08	13800	9GDA08	14510	9GDB08	14510	9GDC08	15810
 Pull Rod Assembly with nuts, spring & washer	9GDS29	5660	9GDA29	5925	9GDB29	7325	9GDC29	11260
Grease Nipple (1 set consist 8 Nos.)	9GDS09	1980	9GDA09	2100	9GDB09	2100	9GDC09	2120
 Shoe Assembly with Clamp & Bolts (1 set consist 2 Nos.) for inch/mm	9GDS10/ 9GDS11	14405	9GDA10/ 9GDA11	14350	9GDB10/ 9GDB11	17795	9GDC10/ 9GDC11	28010
 Shoe Lining without Bolts (1 set consist 2 Nos.) for inch for mm	9GDS12/ 9GDS13	4890	9GDA12/ 9GDA13	5080	9GDB12/ 9GDB13	6400	9GDC12/ 9GDC13	9235
 Shoe Lining with Bolts (1 set consist 2 Nos.) for inch for mm	9GDS23/ 9GDS26	6605	9GDA23/ 9GDA26	7325	9GDB23/ 9GDB26	9235	9GDC23/ 9GDC26	13185
 Dust Cover (made of jeans cloth & painted with fire reterdent al. paint).	-	-	9GDA30	8150	9GDB30	8150	9GDC30	9695
 mm Size Cast Steel Drum without Hard Chrome Plaiting	9GDS15/ (150mm) 9GDS14 (160mm)	15745	9GDA14	17325	9GDB14	26670	9GDC14	44935
mm Size Cast Steel Drum with Hard Chrome Plaiting	9GDS15P/ (150mm) 9GDS14P (160mm)	21260	9GDA14P	24795	9GDB14P	38715	9GDC14P	65120
 Cast Steel Drum without Hard Chrome Plaiting* for inch	-	-	9GDA15	17965	9GDB15	27645	9GDC15	46735
Cast Steel Drum with Hard Chrome Plaiting* for inch	-	-	9GDA15P	25780	9GDB15P	39665	9GDC15P	67770

* For brakes manufactured upto September 07. # For brakes manufactured after September 07 (pins are different).

***GST to be charged extra on all DC Brakes, Brake Spares, Resistance & Rectifier Panel & Resistance Boxes.**

GST to be charged extra

Spares & Accessories - DC Brakes

HSN Code : 8505

Description	16"/400 mm		19"/500 mm		23"/600 mm		30"/700 mm/800mm	
	Cat No.	List Price [₹]	Cat No.	List Price [₹]	Cat No.	List Price [₹]	Cat No.	List Price [₹]
 Coil Shunt	9GDD01	192395	9GDE01	270125	9GDF01	424510	9GDG01	961760
 Coil Series	for inch 9GDD02 for mm 9GDD03	419095	9GDE02 9GDE03	546655	9GDF02 9GDF03	845030	-	-
 Torque Adj. Screw Assembly	9GDD04	13795	9GDE04	19665	9GDF04	31430	9GDG04	65830
 Torque Spring	9GDD05	42450	9GDE05	58730	9GDF05	97245	9GDG05	208700
 Wedge Assembly with Bolt, for inch for mm	9GDD20/ 9GDD22	5315	9GDE20/ 9GDE22	7970	9GDF20/ 9GDF22	12495	9GDG20/ 9GDG22	27660
 Pin set for Lever & Armature Consisting of	for inch 9GDD06* for mm 9GDD06-2#	11260	9GDE06* 9GDE06-2#	11260	9GDF06* 9GDF06-2#	15810	9GDG06 ⁺⁺	47835
a) Pin Lever 2 Nos. b) Pin Armature 2 Nos.								
 Collar Set of Lever & Armature Consisting of	9GDD07	8780	9GDE07	8610	9GDF07	10760	9GDG07 ⁺	17660
a) Collar Lever 4 Nos. b) Collar Armature 4 Nos.								
 Bush Set for Lever & Armature Consisting of	9GDD08	16175	9GDE08	16945	9GDF08	21685	9GDG08 ⁺⁺	38575
a) Bush Lever 4 Nos. b) Bush Armature 4 Nos.								
 Pull Rod Assembly with nuts, spring & washer	9GDD29	17070	9GDE29	23605	9GDF29	31715	9GDG29	82955
 Grease Nipple (1 set consist 8 Nos.)	9GDD09	2160	9GDE09	3710	9GDF09	3710	9GDG09	4105
 Shoe Assembly with Clamp & Bolts for inch (1 set consist 2 Nos.)	for mm 9GDD10/ 9GDD11	42515	9GDE10/ 9GDE11	58810	9GDF10/ 9GDF11	94020	9GDG10/ 9GDG11	211585
 Shoe Lining without Bolts	for inch 9GDD12/ (1 set consist 2 Nos.) for mm 9GDD13	14470	9GDE12/ 9GDE13	23605	9GDF12/ 9GDF13	34920	9GDG12/ 9GDG13	65975
 Shoe Lining with Bolts	for inch 9GDD23/ (1 set consist 2 Nos.) for mm 9GDD26	17795	9GDE23/ 9GDE26	29435	9GDF23/ 9GDF26	45735	9GDG23/ 9GDG26	81590
 Dust Cover (made of jeans cloth & painted with fire reterdent al. paint).	9GDD30	10490	9GDE30	12965	9GDF30	13600	9GDG30	17620
 mm Size Cast Steel Drum without Hard Chrome Plaiting	9GDD14	56185	9GDE14	91460	9GDF14	127195	-	-
 mm Size Cast Steel Drum with Hard Chrome Plaiting	9GDD14P	83645	9GDE14P	133600	9GDF14P	194575	-	-
 Cast Steel Drum without Hard Chrome Plaiting* for inch	9GDD15	58595	9GDE15	95745	9GDF15	130685	-	-
 Cast Steel Drum with Hard Chrome Plaiting* for inch	9GDD15P	87420	9GDE15P	140065	9GDF15P	203915	9GDG15P	345480

* For brakes manufactured upto September 07. # For brakes manufactured after September 07 (pins are different).
+ Consist of strap, Brass Shim & spring Plate ++ Only for Armature +++ Suitable for 800mm

***GST to be charged extra on all DC Brakes, Brake Spares, Resistance & Rectifier Panel & Resistance Boxes.**



GST to be charged extra

Spare Selenium Type Bridge Rectifiers

HSN Code : 8505

Rectifier Code / Part No.	Recommended to operate brake at 415V AC		Qty. per set	List Price [₹]
	Individual	Simultaneous		
9GDX01	1x8"/200mm	-	2	17140
9GDX02	1x10"/250mm	2x8"/200mm	2	25575
9GDX03	1x13"/300mm 1x16"/400mm	2x10"/250mm	2	34635
9GDX04	1x19"/500mm	2x13"/300mm 2x16"/400mm	2	45735
9GDX05	1x23"/600mm	2x19"/500mm	2	65215
9GDX06	-	2x23"/600mm	2	130490
9GDX07	1x30"/700 & 800mm	-	2	180945



GST to be charged extra

Spare Resistances

HSN Code : 8505

Used in resistance and rectifier panels	Cat. No.	Ohms	Watts	List Price [₹]
CACA1*, CACB1*, CACC1*, CACD1*, CACJ2*	9GDX32	32	200	3042
CACA1*, CACB1*, CACC1*, CACF1*, CACG1*, CACL2*, CACP2*, CACJ2*	9GDX42	42	200	
CACS2*	9GDX47	47	200	
CACB1*, CACE1*, CACF1*, CACG1*, CACJ2*, CACK2*, CACM2*, CACN2*	9GDX52	52	200	
CACS1*	9GDX64	64	100	
CACA1*, CACB1*, CACD1*, CACE1*, CACF1*, CACG1*, CACJ2*, CACK2*, CACM2*, CACN2*, CACP2*	9GDX80	80	200	
CACA1*, CACD1*, CACK2*, CACL2*	9GDX112	112	200	
CACS1*, CACS2*	9GDX112A	112	125	

GST to be charged extra

Optional Features - DC Brakes

HSN Code : 8505

Brakes Size		Manual Release List Price [₹]	Residual Magnetism Adjustment List Price [₹]	Limit Switch Attachment List Price [₹]	
Inch	mm			1NO+1NC (LSA)	2NO+2NC (LSA-2)
8	150/160/200	6470	6160	12580	13260
10	250	6470	7220		
13	300	8870	10730		
16	400	9500	15995		
19	500	14760	22190		
23	600	20670	25060		

Note : Suffix following codes to complete brakes code with optional features.

- MR = For Manual Release
- RM = For Residual Magnetism
- LS = For Limit Switch (1NO+1NC)
- LS-1 = For Limit Switch (2NO+2NC)
- RR = For Manual Release + Residual Magnetism
- RL = Residual Magnetism + Limit Switch
- ML = For Manual Release + Limit Switch
- RS = For Manual Release + Residual Magnetism + Limit Switch

To order Spare Limit Switch assembly, cat codes are:

- LSA = Limit Switch with fitting Arrangement (1NO + 1NC)
- LSA-2 = Limit Switch (2NO + 2NC) with fitting Arrangement

***GST to be charged extra on all DC Brakes, Brake Spares, Resistance & Rectifier Panel & Resistance Boxes.**

Industrial Automation & Safety

- Limit Switches
- Foot Switches
- Pneumatic Timers
- Electronic Timers
- AC Drives
- Digital DC Drives
- e-prox Sensors
- Plug-in Relays

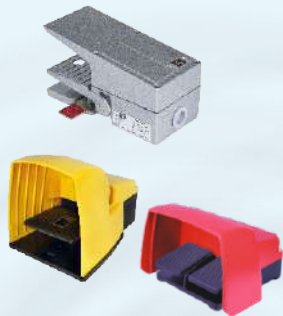

Heavy Duty Limit Switch - Snap Action Type NL IP 67

HSN Code : 8536

Type	Description	Cat. No. Screw Terminal (1NO+1NC)	MRP [₹]	Cat.No. Precabled (1NO+1NC)	MRP [₹]	Cat. No. Screw Terminal (2NO+2NC)	MRP [₹]	Cat. No. Precabled (2NO+2NC)	MRP [₹]
Roller Lever	Standard-38MM Standard-76.2mm Adjustable	NLL1 NLL2 NLLA	2645	NLL1C NLL2C NLLAC	2885	NLL1-22 NLL2-22 NLLA-22	4070	NLL1-22C NLL2-22C NLLA-22C	4215
	Maintained Type Maintained Type Maintained Type	NLL1M NLL2M NLLAM	2965	NLL1MC NLL2MC NLLAMC	3115	NLL1M-22 NLL2M-22 NLLAM-22	4500	NLL1M-22C NLL2M-22C NLLAM-22C	4585
Push Roller	Top Side	NLTPR	2645	NLTPRC	2885	NLTPR-22	4070	NLTPR-22C	4215
		NLSPR	2905	NLSPRC	3115	NLSPR-22	4390	NLSPR-22C	4585
Push Button	Top Adjustable Side Adjustable	NLTPBA	2645	NLTPBAC	2885	NLTPBA-22	3960	NLTPBA-22C	4215
		NLSPBA	2905	NLSPBAC	3115	NLSPBA-22	4390	NLSPBA-22C	4585
Cat Whisker	Nylon Rod Steel Rod	NLCW	2320	NLCWC	2500	NLCW-22	3870	NLCW-22C	4070
		NLJW	2645	NLJWC	2825	NLJW-22	4070	NLJW-22C	4215

- IP 67 degree of Protection
- Choice of 16 Operating Heads
- Interchangeable heads ensures complete modularity and flexibility
- Zinc Die cast body for Heavy duty applications
- Easily replaceable contact blocks
- Precabled version with 2m cable length

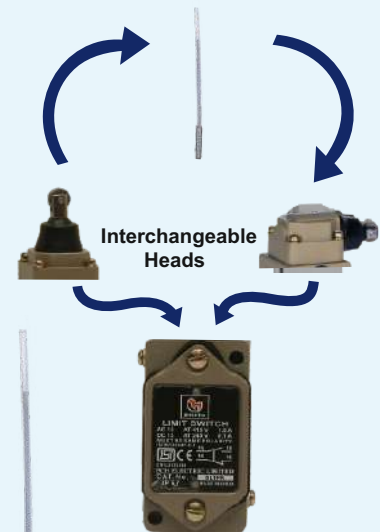



Mini Limit Switch

HSN Code : 8536

Type		Cat. No.	MRP [₹]
General Purpose Type		DLSMAR	1615
Top Plunger	Standard	DLSMPP	1615
Push Roller	Standard	DLSMRP	1615
Push Roller	Cross	DLSMRPX	1615
Roller Lever	30mm	DLSMRL	1615
Roller Lever	Adjustable	DLSMRLA	1665
Rod Arm	Adjustable	DLSMJWA	1665
Cat's Whisker	Steel Spring	DLSMSW	1765
Flexible Rod	Nylon	DLSMSR	1765

- Conforming to IS/IEC 60947-5-1
- Compact Design requiring less mounting space
- Zinc Die cast base & high end polyamide cover ensuring robustness & excellent aesthetics
- Unique Cross bar contacts for enhanced reliability
- Dust proof, Water proof & Oil resistance construction

Applications

- Lifts and Escalators
- Machine Tools
- Food and Beverages
- Textile Machines
- Packaging & Printing Machines

Available Operating Heads

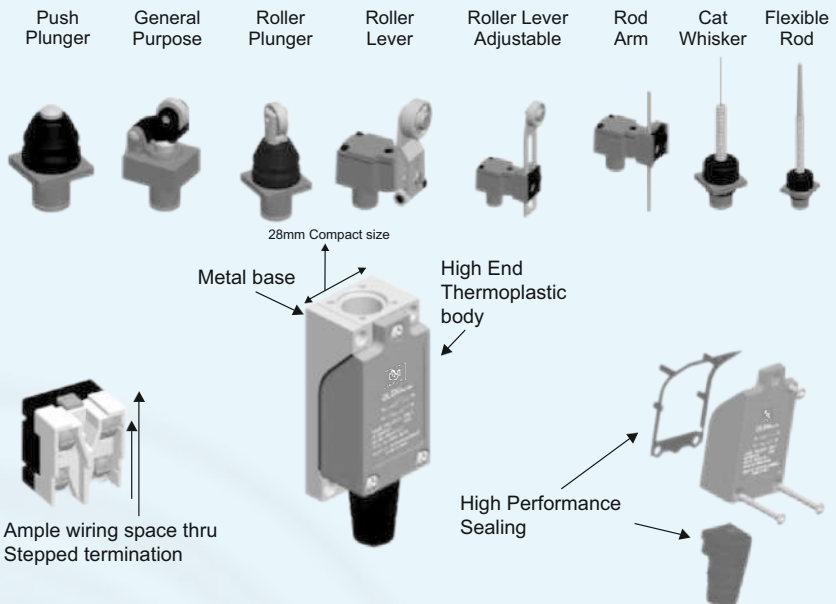

Precision Limit Switch

HSN Code : 8536



- Conforming to IS/IEC 60947-5-1
- Snap action contacts
- Frequency of operation 2500 Operations / hr
- Mechanical life : 20 million operations
- Electrical life : 10 million operations

Type of Operator	1NO+1NC		2NO+2NC		Lot Size
	Cat. No.	MRP [₹]	Cat. No.	MRP [₹]	
Roller Lever	PSRL-L or R	1195	PSRL-L-2 or R-2	1530	1
Six Inch Lever	PSSIL-L or R	1195	PSSIL-L-2 or R-2	1530	
Top Push Roller	PSTPR*	1195	PSTPR*-2	1530	
Top Push Button	PSTPB	1195	PSTPB-2	1530	
Type	Cat. No	MRP [₹]	Cat. No	MRP [₹]	Lot Size
Spare Contact Block	SP20S1	1120	SP20S2	1430	

* A - Top push roller in line with contact block
 B - Top push roller perpendicular to contact block

Limit Switch for 125°C Application*

HSN Code : 8536

Type	Cat. No.	MRP [₹]
with 1NO + 1NC Roller Lever Top Push Roller	LL1-150S-M LTPR-150S-M	9475

*Refer to our nearest sales office for specification & details

Heavy Duty General Purpose Limit Switch

HSN Code : 8536

Snap Action Type L	Angular Roller Top Plunger	LLGS LPGS	1770
-----------------------	-------------------------------	--------------	------

Oil Tight Limit Switch - Snap Action Type L IP 65

HSN Code : 8536

Type	Description	Cat. No.	MRP [₹]
Roller Lever	Standard-38MM	LL1	3790
	Standard-76.2mm	LL2	
	Adjustable	LLA	
Push Roller	Maintained Type LL1	LL1M	3960
	Maintained Type LL2	LL2M	
	Maintained Type LLA	LLAM	
Push Button	Top	LTPR	3700
	Side	LSPR	4160
Push Button	Top Adjustable	LTPBA	4015
	Side Adjustable	LSPBA	
Cat Whisker	Nylon Rod	LCW	3035
	Steel Rod	LJW	3765

Oil Tight Limit Switch - Spares

HSN Code : 8538

Description	Suitable for	Cat. No.	MRP [₹]
38 mm lever	NLL1, LL1	SP40L1	630
76.2 mm lever	NLL2, LL2	SP40L2	795
Adjustable lever	NLLA, LLA	SP40LA	795
Operating Head	LLGS, LPGS	SP40HLG	1140
Operating Head	Roller Lever Type	SP40HL	1235
Operating Head Maintained	Roller Lever Maintained Type	SP40HLM	1420
Operating Head	Top Push	SP 40HTP*	1235
	Side Push	SP 40HSP*	1365
Operating Head	Cat Whisker Nylon Rod	SP40CW	850
	Cat Whisker Steel Rod	SP40JW	1140
Limit Switch Unit Assembly 1NO+1NC	Type 'L' & 'NL' (Except LLGS / LPGS)	SP40S1	1665
Limit Switch Unit Assembly 2NO+2NC	Type 'L' & 'NL' (Except LLGS / LPGS)	SP40S2	3030
Limit Switch Unit Assembly 1NO+1NC	LLGS / LPGS	SP40S1WOM	1155
Oil tight Conduit	Type 'NL'	SP40CE	675

* B = Button R = Roller

Bravo Series - Heavy Duty Limit Switch

HSN Code : 8536

Type	Description	Cat. No.	MRP [₹]
Roller Lever	Standard-38MM	BALRL38	1575
	Standard-76.2mm	BALRL76	
	Adjustable	BALRLA	
Push Roller	Top	BALPRT	1575
	Side	BALPRS	1735
Push Button	Top Adjustable	BALPBT	1575
	Side Adjustable	BALPBS	1735
Cat Whisker	Nylon Rod	BALCWN	1605
	Steel Rod	BALCWS	1575

Salient Features:

- IP 67 degree of Protection
- 1NO+1NC Contact Block
- Choice of 9 Operating Heads
- Aluminium Die-cast body

New
BRAV Series
 LIMIT SWITCH



BALRL38



BALRL76



BALRLA



BALPRT



BALPBT



BALPRS



BALPBS



BALCWN



BALCWS

BSG Foot Switch



BSG2M

- Full Metal Body with Shielded Guard for Pedal
- 2 Positions
- Yellow Colour Shielded Guard for better visibility

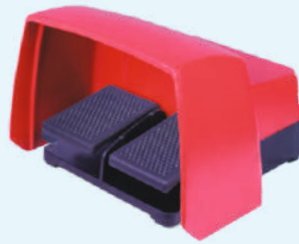

BSG2C

- Full Metal Body with Shielded Guard for Pedal
- Glass Filled Nylon Pedal
- 2 Positions
- Red Colour Shielded Guard for better visibility

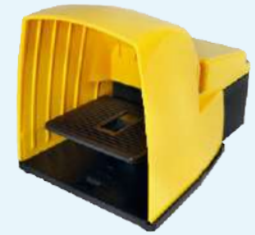

BSG2P

- Full Plastic Body with Shielded Guard for Pedal
- 2 Positions
- Yellow Colour Shielded Guard for better visibility

HSN Code : 8538

BSG Range of Foot switches		
Cat code	Description	MRP [₹]
BSG2MX1	FOOT SWITCH METAL GUARD & SHIELD 1NO+1NC	5890
BSG2MX2	FOOT SWITCH METAL GUARD & SHIELD 2NO+2NC	6315
BSG2CY1	FOOT SWITCH DOUBLE PEDAL 2 X 1NO+1NC	9055
BSG2PX1	FOOT SWITCH PLASTIC GUARD&SHIELD 1NO+1NC	2830
BSG2PX2	FOOT SWITCH PLASTIC GUARD&SHIELD 2NO+2NC	3260

FSG Foot Switch

HSN Code : 8536



Number of Contact Blocks	Total contacts available	No. of position	Description	Cat. No.	MRP [₹]	Lot Size
One	1NO+1NC	2	With Guard	FSGX1	5915	1
One	1NO+1NC	2	With Latch	FSGX1L	6225	
One	2NO+2NC	2	With Guard	FSGX2	6415	
One	2NO+2NC	2	With Latch	FSGX2L	6695	
Two	2NO+2NC	2	With Guard	FSGY1	7245	
Two	2NO+2NC	2	With Latch	FSGY1L	7705	
Two	4NO+4NC	2	With Guard	FSGY2	8455	
Two	4NO+4NC	2	With Latch	FSGY2L	8610	
Two	2NO+2NC	3	With Guard	FSGZ1M	7355	
Two	4NO+4NC	3	With Guard	FSGZ2M	8430	

Note : Latching unit (with suffix L) is provided with X & Y versions only.

Spares for Foot Switch

HSN Code : 8538



Description	Suitable For	Cat No.	MRP [₹]
Spare Contact Block 1NO+1NC	FSG & BSG	SP20S1	1120
Spare Contact Block 2NO+2NC	FSG & BSG	SP20S2	1430
Spare Cover with Guard	FSG	SP20CG	2375

- 2 Position and 3 Position
- 1NO+1NC/2NO+2NC/4NO+4NC contact blocks
- With Guard
- Oil tight and water tight enclosure for contact block
- Mechanical and electrical life : 10 million operation
- Suited for heavy duty applications such as :
 - Machine Tools
 - Rubber and Tyre making machines
 - SPMs
 - Welding Machines
- Suffix X1 = One Block of 1NO+1NC
- X2 = One Block of 2NO+2NC
- Y1 = Two Blocks of 1NO+1NC
- Y2 = Two Blocks of 2NO+2NC

Pneumatic Timer

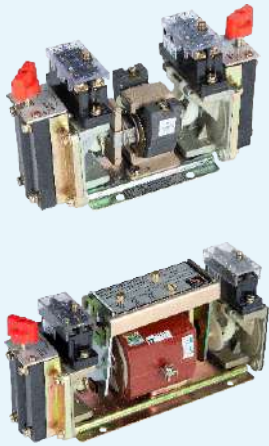

- 30 sec / 60 sec/180 sec
- AC and DC Supply
- 1 NO+1NC / 2 NO+2NC Contact Blocks
- Completely enclosed timing head ensures excellent timings in adverse environmental conditions
- Encapsulated coil for better resistance against moisture and corrosion
- Completely maintainable i.e Coil , Contact blocks and Timing head can be replaced
- Special timer for Railway application



Pneumatic Timers Time Delay Relay-Electro Pneumatic

HSN Code : 9107

Type	Time Range (Secs.)	Contact Configuration		Cat No.	MRP [₹]	
		Time Block	Instantaneous Block		AC	DC
PN	0.05 - 30 Sec	1NO + 1NC	-	KRTPN10 ⁰ -0	6385	9565
	0.05 - 60 Sec	1NO + 1NC	-	KRTPN10 ¹ -1	6600	10095
	0.05 - 180 Sec	1NO + 1NC	-	KRTPN10 ³ -3	7460	11010
	0.05 - 30 Sec	2NO + 2NC	-	KRTPN20 ⁰ -0	7175	10235
	0.05 - 60 Sec	2NO + 2NC	-	KRTPN20 ¹ -1	7325	10360
	0.05 - 180 Sec	2NO + 2NC	-	KRTPN20 ³ -3	7875	11125
PNI	0.05 - 30 Sec	1NO + 1NC	1NO + 1NC	KRTPN11 ⁰ -0	7780	11130
	0.05 - 60 Sec	1NO + 1NC	1NO + 1NC	KRTPN11 ¹ -1	8825	12155
	0.05 - 180 Sec	1NO + 1NC	1NO + 1NC	KRTPN11 ³ -3	9660	12300
	0.05 - 30 Sec	2NO + 2NC	2NO + 2NC	KRTPN22 ⁰ -0	9750	12700
	0.05 - 60 Sec	2NO + 2NC	2NO + 2NC	KRTPN22 ¹ -1	9855	13360
	0.05 - 180 Sec	2NO + 2NC	2NO + 2NC	KRTPN22 ³ -3	10565	14130
Type	Time Range (Secs.)	On-Delay Block	Off-Delay Block	Cat No.	AC	DC
PCN	0.05 - 30 Sec	1NO + 1NC	1NO + 1NC	KRTPCN11 ⁰ -0	10530	14105
	0.05 - 60 Sec	1NO + 1NC	1NO + 1NC	KRTPCN11 ¹ -1	11065	14220
	0.05 - 180 Sec	1NO + 1NC	1NO + 1NC	KRTPCN11 ³ -3	12565	15710
	0.05 - 30 Sec	2NO + 2NC	2NO + 2NC	KRTPCN22 ⁰ -0	11840	15480
	0.05 - 60 Sec	2NO + 2NC	2NO + 2NC	KRTPCN22 ¹ -1	12405	15660
	0.05 - 180 Sec	2NO + 2NC	2NO + 2NC	KRTPCN22 ³ -3	13990	17075

PN, PNI Time Delay Relay will be supplied only as on-delay

- To complete Cat. No. Suffix Voltage code from Table

Timer for Railway Application

HSN Code : 9107

Type	Time (Secs.)	Contact Configuration		Cat No.	MRP [₹]	
		Time Block	Instantaneous Block		AC	DC
PN	120	2NO + 2NC	-	KRTPN20A-2R	7670	-
	150	2NO + 2NC	-	KRTPN20A-3R	7670	-

Accessories for Time Delay Relay HSN Code : 9107

Description	Cat. No.	MRP [₹]	Lot Size
Contact Block			
1NO+1NC Timed	SP20S3+	1455	1
2NO+2NC Timed	SP20S4+	1900	
1NO+1NC Inst.	SP20S5+	1455	
2NO+2NC Inst.	SP20S6+	1900	
Magnet Coil			
AC-PN Relays	SP20MC	1980	1
AC-PNI & PCN Relays	SP20MC1	1980	
DC Relays	SP20MC2	6390	
Return Spring*	SP20RS	340	1
(PNI & PCN) Coil Clip*	SP20CC	540	
Magnet frame assembly without coil	SP20 MAIMA1	2880	1
Knob assembly	SP20KA	105	10

* These are supplied with plastic cover

* For DC Timers only

- To complete suffix voltage code refer to the table

- High Repeat Accuracy
- Operating Temperature - 40⁰ to +65⁰
- Mechanical and Electrical Life - 10 million operations

Voltage Suffix Code

Coil Voltage	24	110	220	240	415
AC Suffix Code*	U	A	B	K	M
DC Suffix Code	U1	A1	B1	K1	-

* KRTPN timers with 550V AC coil voltage, Prices available on request



- On Delay
- Off Delay
- Cyclic
- Multifunction
- Widest timing range from 0.1 sec to 10 Hours in Single Unit
- Calibrated time scale for easy time setting
- DIN rail mounting
- Excellent repeat accuracy

Multi Function

- 4 Functions - On delay, Interval, Off delay, Single Shot
- Multi Time Range - Sec / Min / Hr
- Universal Voltage - 24 V- 230V AC/DC
- Large calibrated dial for easy and accurate time setting
- Compact Design
- LED indications for Input supply and Output status
- Surface mounting & DIN rail mounting
- 1 changeover relay output (SPDT)
- All Purpose Timer

Electronic Timers

HSN Code - 9107

Chronos Delay on make type BAR 0.1 Sec. - 10 Hrs. 240V AC; 24V AC/DC or 110V AC; 24V AC/DC or 12V DC	SBT00-00N	2360
Delay on break type BCR 0.1 Sec. - 10 Hrs. 240V AC; 24V AC/DC or 110V AC; 24V AC/DC or 12V DC	SBT01-00N	2570
Recycling type BDR 0.1 Sec. - 10 Hrs. 240V AC; 24V AC/DC or 110V AC; 24V AC/DC	SBT02-00N	3380
Multifunction type BLR 0.1 Sec. - 10 Hrs. 240V AC; 24V AC/DC or 110V AC; 24V AC/DC	SBT03-00N	2570

■ Voltage Codes

Type	Voltage	Voltage Code
B	240V AC; 24 V AC/DC	1
	110 V AC; 24 V AC/DC	2
	12 V DC	5

Universal Voltage, Multi Time, Multi Function - IBTMU

HSN Code - 9107

Product	Cat No.	Time Range	Function	Voltage	MRP [₹]
	IBT04500	0.1S - 10 Hr.	On Delay, Off Delay, Interval, Single Shot	24-240V AC/DC	2430



BTR17 - Star Delta Timer 17.5mm Width

HSN Code - 9107

- Wide Time ranges
- Two Transition times - 50ms/100ms
- Wide Voltage Supply - 240 - 415V AC
- Two C/O Contacts
- Width 17.5 mm
- Flame Retardant UL94 -V0 enclosure
- CE approved & RoHS Compliance

Product	Description	Cat No.	MRP [₹]
	Star-Delta Timer 0-60 Sec 240-415V AC	BTR174622	1010

New

Electronic Timer-BTR17 Series - 17.5mm width

HSN Code - 9107

- On Delay
- Off Delay
- Cyclic
- Multifunction - 12 functions
- LED Indications for Power and Relay status
- 1C/O Contacts
- Microcontroller based timer
- Compact size 17.5mm Wide
- CE marked & RoHS compliant
- EMC/EMI Compatible
- Flame Retardant UL94-V0 Enclosure





Product	Cat No.	Description	Time Range	MRP [₹]
	BTR170101	ON delay Timer 240V AC/24V AC/DC	0.3 sec to 30Hr	800
	BTR170201	ON delay Timer 110V AC/24V AC/DC	0.3 sec to 30Hr	1280
	BTR170501	ON delay Timer 12V DC	0.3 sec to 30Hr	1050
	BTR171101	OFF delay Timer 240V AC/24V AC/DC	0.3 sec to 30Hr	960
	BTR171201	OFF delay Timer 110V AC/24V AC/DC	0.3 sec to 30Hr	960
	BTR171501	OFF delay Timer 12V DC	0.3 sec to 30Hr	1050
	BTR172011	Cyclic timer 12-240V AC/DC	0.1 sec to 100Hr	1640
	BTR173011	Multi-function timer 12-240V AC/DC, 12 Function	0.1 sec to 100Hr	1640

New

Electronic Timer-BTR22 Series - 22.5mm width

HSN Code - 9107

- On Delay
- Off Delay
- Cyclic
- Multifunction - 13 functions
- Wide time range & voltage
- High accuracy
- 2C/O Contacts
- LED Indications or Power and Relay status
- Micro controller based timer
- Compact size 22.5mm Wide
- Low Power Consumption
- 35mm DIN Rail mounting
- EMC/EMI Compatible
- CE marked & RoHS Compliant
- Flame Retardant UL94-V0 Enclosure

Product	Cat No.	Description	Time Range	MRP [₹]
	BTR220012	ON delay Timer 24 - 240V AC/DC 2 C/O Contact	0.1 sec to 100Hr	1370
	BTR221012	OFF delay Timer 24 - 240V AC/DC 2 C/O Contact	0.1 sec to 100Hr	1250
	BTR222012	Cyclic Timer 24 - 240V AC/DC 2 C/O Contact	0.1 sec to 100Hr	1700
	BTR223012	Multifunction Timer 24 - 240V AC/DC 2 C/O Contact	0.1 sec to 100Hr	1640

SINUS B AC Drive



- 0.37~2.2Kw, Input-1Phase 200-230V AC
- Output - 3 Phase 200-230V AC
- Sensorless vector and V/F control
- Build in PID function

AC Drive



Sinus Penta AC Drive

- 4.5 - 3000 KW, 3 Phase 380 - 415 VAC
- One Drive - Five functions
 - Vector modulation IFD functionality for general-purpose applications
 - Sensorless vector VTC functionality for high torque-demanding applications
 - Vector FOC functionality with an encoder for accurate torque requirements and a wide speed range
 - Vector SYN functionality for applications with brushless, synchronous motors
 - RGN functionality for the inverter application as an AC/DC converter for the DC supply of multiple drives
- In built Braking chopper upto 132KW rating (S30)
- Serial communication port RS485 – MODBUS RTU Protocol
- Starting Torque upto 240% max
- PID function / second PID function
- Control keypad panel with 12 keys and large back-lit LCD
- Intelligent cooling system
- Encoder feedback
- Full compatibility with teleservice software, "REMOTE DRIVE" on internet
- Compatible with Easy Harmonics, tool for the calculation of Harmonic currents

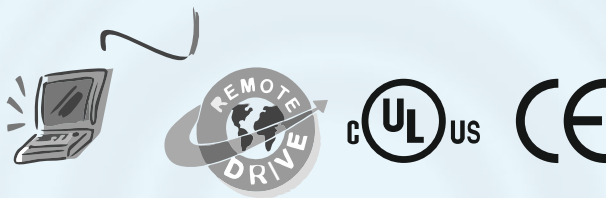

* For the prices of above mentioned products please contact our nearest sales office.

Digital DC Drives



- From 10A to 4500A (2.4 KW to 2205 KW)
3 Phase 220-690VAC
- 2 & 4 Quadrant digital drive
- Local control from keypad
- 12/7 programmable I/Os
- Predictive control and field boost
- Feedback from dynamo/encoder/armature
- Auto switching in armature F/B against
encoder/tacho feed back failure

Digital DC Drives

HSN Code - 8504

Cat. No.	Armature Current (A)	Field Current (A)
DCREG*.10 POT440V	10	5
DCREG*.20 POT440V	20	5
DCREG*.40 POT440V	40	5
DCREG*.70 POT440V	70	5
DCREG*.100 POT440V	100	5
DCREG*.150 POT440V	150	15
DCREG*.180 POT440V	180	15
DCREG*.250 POT440V	250	15
DCREG*.350 POT440V	350	15
DCREG*.410 POT440V	410	35
DCREG*.500 POT440V	500	35
DCREG*.600 POT440V	600	35
DCREG*.900 POT440V	900	35
DCREG*.1200 POT440V	1200	35

* to complete cat code suffix : 2- for II Quadrant drive 4 - for IV Quadrant drive

* For the prices of above mentioned products please contact our nearest sales office.

@PROX Range

Standard Version of Inductive Proximity Switches

HSN Code - 8536



- Sizes from 8mm to 30mm Dia
- Switching Distance from 1.5mm to 15mm
- IP 67, CE Marked
- Sensors with Linear output (4 - 20 mA / 0-10VDC)

General Specifications

- High switching capacity
- 200mA upto 12mm Dia
- 400mA for 18mm and 30mm Dia
- Wide range of outputs
- Voltages AC/DC
- Status LED Indication
- Built in Short circuit protection

Special Versions

- Non Standard sizes from 4mm to 80mm dia
- High temperature sensors upto 125 Deg C
- Square / Slot / Rectangular sensors
- Sensor with shielded cable

Cat. No.	Dia (mm)	Nominal Sn Distance (mm)	Output	Max. Load (mA)	MRP [₹]	Lot Size
Flush Version Nominal Voltage 12-30V DC 3 Wire Output LED Indication Integrated cable 3C/2M						
DINE8SP10	8	1.5	PNP-NO	100	1340	10
DINE8SN10	8	1.5	NPN-NO	100	1340	
DINE12SP10	12	2	PNP-NO	200	1110	
DINE12SN10	12	2	NPN-NO	200	1110	
DINE18SP10	18	5	PNP-NO	200	1160	
DINE18SN10	18	5	NPN-NO	200	1160	
DINE30SP10	30	10	PNP-NO	400	1560	
DINE30SN10	30	10	NPN-NO	400	1560	
Non Flush Version Nominal Voltage 12-30V DC 3 Wire Output LED Indication Integrated cable 3C/2M						
DINE8NP10	8	2	PNP-NO	100	1340	10
DINE8NN10	8	2	NPN-NO	100	1340	
DINE12NP10	12	4	PNP-NO	200	1110	
DINE12NN10	12	4	NPN-NO	200	1110	
DINE18NP10	18	8	PNP-NO	200	1160	
DINE18NN10	18	8	NPN-NO	200	1160	
DINE30NP10	30	15	PNP-NO	400	1560	
DINE30NN10	30	15	NPN-NO	400	1560	
Flush Version Nominal Voltage 240V AC* 2 Wire Output LED Indication Integrated cable 3C/2M						
DINE12SA10	12	2	NO	200	1430	10
DINE12SA01	12	2	NC	200	1430	
DINE18SA10	18	5	NO	400	1510	
DINE18SA01	18	5	NC	400	1510	
DINE30SA10	30	10	NO	400	1750	
DINE30SA01	30	10	NC	400	1750	
Non Flush Version Nominal Voltage 240V AC* 2 Wire Output LED Indication Integrated cable 3C/2M						
DINE12NA10	12	4	NO	200	1430	10
DINE12NA01	12	4	NC	200	1430	
DINE18NA10	18	8	NO	400	1510	
DINE18NA01	18	8	NC	400	1510	
DINE30NA10	30	15	NO	400	1750	
DINE30NA01	30	15	NC	400	1750	

*110V AC input voltage is also available, For 110V AC replace A by 2A

@PROX Range

Capacitive Proximity Switches

HSN Code - 8536



- Sizes: 18mm and 30mm dia
- Switching Distance: upto 15mm
- IP 67, CE Compliance

General Specifications

- Max. load current : 400mA
- Wide range of outputs
- Built in Short circuit & polarity reversal protection
- Sensitivity adjustment thru trimmer

Cat. No.	Dia (mm)	Nominal Sn Distance (mm)	Output	Max. Load (mA)	MRP [₹]	Lot Size
Flush Version 12-30V DC 3 Wire Output LED Indication Integrated 3C/2M						
DCAE18SN10	18	1 to 5	NPN-NO	400	2740	10
DCAE18SP10	18	1 to 5	PNP-NO	400	2740	
DCAE30SN10	30	1 to 10	NPN-NO	400	3130	
DCAE30SP10	30	1 to 10	PNP-NO	400	3130	
Non Flush Version 12-30V DC 3 Wire Output LED Indication Integrated 3C/2M						
DCAE18NN10	18	2 to 10	NPN-NO	400	2740	10
DCAE18NP10	18	2 to 10	PNP-NO	400	2740	
DCAE30NN10	30	3 to 15	NPN-NO	400	3130	
DCAE30NP10	30	3 to 15	PNP-NO	400	3130	

Photoelectric Sensors

HSN Code - 8536



- Size : M18 cylindrical
- Mode : diffuse, retro and thru beam
- LED indication
- Sensing distance 20cm to 5mtr.

Special Versions

- Sensors in Rectangular housing

Cat. No.	Dia (mm)	Nominal Sn Distance (mm)	Output	Max. Load (mA)	MRP [₹]	Lot Size
Nominal Voltage : 12-30V DC Diffuse Scan DC 4-W Output LED Indication Prewired with 2 m Cable						
DPHE18D2N11	18	200	NPN-NO+NC	200	4150	10
DPHE18D2P11	18	200	PNP-NO+NC	200	4150	
Nominal Voltage : 12-30V DC Retro Reflective DC 4-W Output LED Indication Prewired with 2 m Cable						
DPHE18RRN11	18	1000	NPN-NO+NC	200	4160	10
DPHE18RRP11	18	1000	PNP-NO+NC	200	4160	
Nominal Voltage : 12-30V DC Through Beam DC 4-W Output LED Indication Prewired with 2 m Cable						
DPHE18TBRP11	18	5000	PNP-NO+NC	200	4980	10
DPHE18TBRN11	18	5000	NPN-NO+NC	200	4980	

Note :

- Prices for Thru Beam, Photo Sensors are inclusive of emitters & receivers.
- Prices for Retro Reflective Sensors are inclusive of reflectors.

ePROX Range

Standard Version of Inductive Proximity Switches

HSN Code - 8536

Cat. No.	Dia (mm)	Nominal Sn Distance (mm)	Output	Connector Size	MRP [₹]	Lot Size
Flush Version Nominal Voltage 12-30V DC 3 Wire Output LED Indication, 200 mA Load upto 12mm & 400 mA for 18 mm						
DINE8SP10K	8	1.5	PNP-NO	M8 Connector	1380	10
DINE8SN10K	8	1.5	NPN-NO	M8 Connector	1380	
DINE12SP10K	12	2	PNP-NO	M12 Connector	1380	
DINE12SN10K	12	2	NPN-NO	M12 Connector	1380	
DINE18SP10K	18	5	PNP-NO	M12 Connector	1390	
DINE18SN10K	18	5	NPN-NO	M12 Connector	1390	
DINE30SP10K	30	10	PNP-NO	M12 Connector	1730	
DINE30SN10K	30	10	NPN-NO	M12 Connector	1730	
Non Flush Version Nominal Voltage 12-30V DC 3 Wire Output LED Indication						
DINE8NP10K	8	2	PNP-NO	M8 Connector	1380	10
DINE8NN10K	8	2	NPN-NO	M8 Connector	1380	
DINE12NP10K	12	4	PNP-NO	M12 Connector	1380	
DINE12NN10K	12	4	NPN-NO	M12 Connector	1380	
DINE18NP10K	18	8	PNP-NO	M12 Connector	1390	
DINE18NN10K	18	8	NPN-NO	M12 Connector	1390	
DINE30NP10K	30	15	PNP-NO	M12 Connector	1730	
DINE30NN10K	30	15	NPN-NO	M12 Connector	1730	
Cat. No.	Description Female Connectors				MRP [₹]	
DM8K3	M8 3-Wire straight connector w/o LED & 2 m cable				1080	10
DM8K390LE	M8 3-Wire "L" type connector with LED & 2 m cable				1080	
DM12K4	M12 4-Wire straight connector w/o LED & 2 m cable				730	
DM12K490	M12 4-Wire "L" type connector w/o LED & 2 m cable				1050	
DM12K490LE	M12 4-Wire "L" type connector with LED & 2 m cable				1140	
Linear Output Inductive Proximity Sensor - Nominal Voltage 24V DC, 2m Integrated Cable						
DINE18LIN	18	5	0 - 10V	2 m long PVC Cable	2350	10
DINE18LINMA	18	5	4 - 20 mA		2350	

Standard Version DC 2 Wire Proximity Switches

HSN Code - 8536

Cat. No.	Dia (mm)	Nominal Sensing Distance (mm)	Output	Max. Load (mA)	MRP [₹]	Lot Size
Flush Version Nominal Voltage 24V DC 2 Wire Output LED Indication, Integrated 3C/2m long PVC Cable 65mm long tubular Metallic Housing						
DINE8SD10	8	1.5	NO	200	1640	10
DINE12SD10	12	2	NO	200	1150	
DINE18SD10	18	5	NO	400	1180	
DINE30SD10	30	10	NO	400	1520	
Non Flush Version, Nominal Voltage 12-30V DC 2 Wire Output LED Indication, Integrated 3C/2m long PVC Cable 65mm long tubular Metallic Housing						
DINE8ND10	8	2	NO	200	1640	10
DINE12ND10	12	4	NO	200	1150	
DINE18ND10	18	8	NO	400	1180	
DINE30ND10	30	15	NO	400	1520	

Note : for NC output, replace suffix 10 by 01

ePROX Range

Short Housing Inductive Proximity Switch-45mm length

HSN Code - 8536

Cat. No.	Dia (mm)	Nominal Sensing Distance (mm)	Output	Max. Load (mA)	MRP [₹]	Lot Size
Flush Version Nominal Voltage 12-30V DC, 3 Wire Output, LED Indication, Integrated 3C/2m long PVC Cable						
45mm long tubular Metallic Housing						
DINE8SP10S	8	1.5	PNP-NO	200	1700	10
DINE8SN10S	8	1.5	NPN-NO	200	1700	
DINE12SP10S	12	2	PNP-NO	200	1190	
DINE12SN10S	12	2	NPN-NO	200	1190	
DINE18SP10S	18	5	PNP-NO	400	1200	
DINE18SN10S	18	5	NPN-NO	400	1200	
Non Flush Version, Nominal Voltage 12-30V DC, 3 Wire Output, LED Indication, Integrated 3C/2m long PVC Cable						
45mm long tubular Metallic Housing						
DINE8NP10S	8	2	PNP-NO	200	1700	10
DINE8NN10S	8	2	NPN-NO	200	1700	
DINE12NP10S	12	4	PNP-NO	200	1190	
DINE12NN10S	12	4	NPN-NO	200	1190	
DINE18NP10S	18	8	PNP-NO	400	1200	
DINE18NN10S	18	8	NPN-NO	400	1200	

Square / Rectangular Proximity Switch

HSN Code - 8536

Cat. No.*	Size (mm)	Nominal Sensing Distance (mm)	Output	Max. Load (mA)	MRP [₹]	Lot Size
Flush Version, Nominal Voltage 12-30V DC, 3 Wire Output, LED Indication, Integrated 3C/2m long PVC Cable, Plastic Housing						
DINE1717SP10P	17x17x30	5	PNP-NO	200	1190	10
DINE5025SP10P	50x25x10	5	PNP-NO	200	1240	
DINE1717SN10P	17x17x30	5	NPN-NO	200	1190	
DINE5025SN10P	50x25x10	5	NPN-NO	200	1240	

* For NC Output, Replace Suffix 10 by 01

** For 110V AC input, Replace A by 2A

*** High Ambient Temp upto 125°C Proximity switch are available on request

Plug in Relays - APA Series



Miniature Plug in Relays



- Type APAM (Miniature)
- 12/6 Amp. (Res.) Contact rating
- 2 Change over / 4 Change over
- Silver Nickle Contacts
- Built in Mechanical Indicator/Latching facility
- Wide Coil Voltages
- 8 Pin / 14 Pin Socket

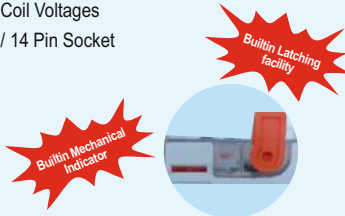

Socket & Clamp (APSM)
35 mm DIN rail mounting
Rating : 6A, 12A, 300V



Universal Relays



- Type APAU
- 10 Amp (Res) Contact rating
- 2 Change over / 3 Change over
- Silver Nickle Contacts
- Built in Mechanical Indicator/ Latching facility
- Wide Coil Voltages
- 8 Pin / 11 Pin Socket

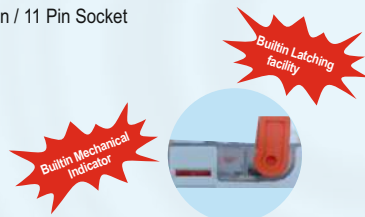

Socket & Clamp (APAU)
35 mm DIN rail mounting Rating : 10 A, 250V



Plug in Relays - Miniature (APAM)

HSN Code - 8536

Coil Voltage	With LED Indication		Contacts	Lot Size
	Cat. No.	MRP [₹]		
14 Pin, Contact rating - 6A (Res.) at 30V DC/250V AC; Mechanical indicator with manual testing/latching lever				
12V DC	APAM412DLE	560	4 C/O	10
24V DC	APAM424DLE	520		
110V DC	APAM4110DLE	640		
24V AC	APAM424ALE	610		
110V AC	APAM4110ALE	610		
230V AC	APAM4230ALE	600		
8 Pin, Contact rating - 6A (Res.) at 30V DC/250V AC; Mechanical indicator with manual testing/latching lever				
12V DC	APAM212DLE	510	2 C/O	10
24V DC	APAM224DLE	490		
110V DC	APAM2110DLE	580		
24V AC	APAM224ALE	570		
110V AC	APAM2110ALE	590		
230V AC	APAM2230ALE	600		
8 Pin, Contact rating - 12A (Res.) at 30V DC/250V AC; Mechanical indicator with manual testing/latching lever				
12V DC	APAN212DLE	540	2 C/O	10
24V DC	APAN224DLE	530		
110V DC	APAN2110DLE	600		
24V AC	APAN224ALE	590		
110V AC	APAN2110ALE	610		
230V AC	APAN2230ALE	630		

Sockets for APAM Plug in Relay

HSN Code - 8538

Cat. No.	Type	MRP [₹]	Lot Size
Screw Terminals, 35mm DIN Rail Mounting			
APSM14	14 pin socket suitable for Miniature plug in relay, 6A	300	10
APSM8	8 pin socket suitable for Miniature plug in relay 12A	240	
APAMCL	Holding Clamp for APAM/APAN Plug in relay	60	

Plug In Relays - Universal (APAU)

HSN Code - 8536

Coil Voltage	With LED Indication		Contacts	Lot Size
	Cat. No.	MRP [₹]		
8 Pin, Contact rating - 10A (Res.) at 30V DC/250V AC; Mechanical indicator with manual testing/latching lever				
12V DC	APAU212DLE	1260	2 C/O	10
24V DC	APAU224DLE	1210		
110V DC	APAU2110DLE	1000		
24V AC	APAU224ALE	940		
110V AC	APAU2110ALE	1000		
230V AC	APAU2230ALE	1000		
11 Pin, Contact rating - 10A (Res.) at 30V DC/250V AC; Mechanical indicator with manual testing/latching lever				
12V DC	APAU312DLE	1270	3 C/O	10
24V DC	APAU324DLE	1220		
110V DC	APAU3110DLE	1070		
24V AC	APAU324ALE	1050		
110V AC	APAU3110ALE	1340		
230V AC	APAU3230ALE	1380		

Sockets for APAU Plug in Relay

HSN Code - 8538

Cat. No.	Type	MRP [₹]	Lot Size
10A, 250V AC, Screw Terminals, 35mm DIN Rail Mounting			
APSU11	11 pin socket suitable for Universal plug in relay, 10Amp	390	10
APSU8	8 pin socket suitable for Universal plug in relay, 10Amp	370	
APAUCL	Holding Clamp for APAU Plug in relay	60	

Plug In Relays - Universal (ASPU)

HSN Code - 8536



- Type ASPU
- 10 Amp (Res) Contact rating
- 2 Change over / 3 Change over

Coil Voltage	Cat. No.	Contacts	MRP [₹]	Lot Size
8 Pin - contact rating 10A (Res.) at 24V DC/240V AC, LED Indication				
12V DC	ASPU212DLE	2 C/O	490	10
24V DC	ASPU224DLE		490	
110V DC	ASPU2110DLE		540	
12V AC	ASPU212ALE		540	
24V AC	ASPU224ALE		580	
110V AC	ASPU2110ALE		570	
240V AC	ASPU2240ALE		630	
11 Pin - contact rating 10A (Res.) at 24V DC/240V AC, LED Indication				
12V DC	ASPU312DLE	3 C/O	590	10
24V DC	ASPU324DLE		580	
110V DC	ASPU3110DLE		630	
24V AC	ASPU324ALE		680	
110V AC	ASPU3110ALE		640	
240V AC	ASPU3240ALE		700	

Plug In Relays - Universal (ASPS)

HSN Code - 8536



- Type ASPS
- 5 Amp (Res) Contact rating
- 2 Change over / 3 Change over

Coil Voltage	Cat. No.	Contacts	MRP [₹]	Lot Size
8 Pin - contact rating 5A (Res.) at 24V DC/240V AC, LED Indication				
12V DC	ASPS212DLE	2 C/O	440	10
24V DC	ASPS224DLE		440	
48V DC	ASPS248DLE		490	
110V DC	ASPS2110DLE		490	
12V AC	ASPS212ALE		470	
24V AC	ASPS224ALE		490	
110V AC	ASPS2110ALE		480	
240V AC	ASPS2240ALE		530	
11 Pin - contact rating 5A (Res.) at 24V DC/240V AC, LED Indication				
12V DC	ASPS312DLE	3 C/O	530	10
24V DC	ASPS324DLE		540	
48V DC	ASPS348DLE		630	
110V DC	ASPS3110DLE		610	
24V AC	ASPS324ALE		510	
110V AC	ASPS3110ALE		540	
240V AC	ASPS3240ALE		630	

Sockets for ASPU / ASPS Plug in Relay

HSN Code - 8538

Cat. No.	Type	MRP [₹]	Lot Size
10A, 240V AC, Screw Terminals, 35mm DIN Rail Mounting			
ASSU11	SOCKET 11 PIN FOR ASPS/ASPU Relay	260	10
ASSU8	SOCKET 8 PIN FOR ASPS/ASPU Relay	200	

* For price of other coil voltage, please contact our nearest sales office.

Plug In Relays - Miniature (ASPM)

HSN Code - 8536



- Type ASPM
- 5 Amp (Res) Contact rating
- 2 Change over / 4 Change over

Coil Voltage	Cat. No.	Contacts	MRP [₹]	Lot Size
14 Pin - contact rating 5A (Res.) at 24V DC/240V AC, LED Indication				
12V DC	ASPM412DLE	4 C/O	410	20
24V DC	ASPM424DLE		400	
48V DC	ASPM448DLE		420	
110V DC	ASPM4110DLE		410	
24V AC	ASPM424ALE		470	
110V AC	ASPM4110ALE		450	
240V AC	ASPM4240ALE		460	
8 Pin - contact rating 5A (Res.) at 24V DC/240V AC, LED Indication				
12V DC	ASPM212DLE	2 C/O	340	20
24V DC	ASPM224DLE		340	
48V DC	ASPM248DLE		410	
110V DC	ASPM2110DLE		400	
24V AC	ASPM224ALE		400	
110V AC	ASPM2110ALE		405	
240V AC	ASPM2240ALE		410	

Sockets - for ASPM Plug in Relay

HSN Code - 8538

Cat. No.	Type	MRP [₹]	Lot Size
5A, 240V AC, Screw Terminals, 35mm DIN Rail Mounting			
ASSM14	SOCKET 14 PIN FOR ASPM Relay	300	20
ASSM8	SOCKET 8 PIN FOR ASPM Relay	220	

* For price of other coil voltage, please contact our nearest sales office.



Shakti DOL & Star Delta Starters

- DOL & Star Delta upto 24 A relay range
- Heavy duty Shakti Contactor
- Wide Band coil voltages (190-400V, 230-420V, 220-240V, 380-415V)
- Encapsulated & Hermetically sealed coil
- Automatic star delta with electronic timer for reliable changeover from star to delta
- Selection of manual & auto resetting of overload relay



Citation DOL & Star Delta Starters

- DOL upto 40 HP
- Semi Automatic upto 40 HP
- Fully Automatic upto 375 HP
- Heavy Duty NHD & Citation Contactor
- Wide Band Coil Voltage (230-360V, 260-400V, 380-415V)
- Automatic Star Delta with Pneumatic Time for Reliable Changeover from Star to Delta
- Selection of Manual & Auto Resetting of Overload Relay



Shakti & Citation P Auto DOL Starters

- Shakti range available upto 24 A overload relay
- Citation P range available upto 40 A overload relay
- Auto start with on delay options:- 5 sec or 5 min or 0.5 sec to 5 min
- Mode of operation:- Auto/ Manual/ Manual SPP with selector on enclosure switch or SPP with inbuilt selector switch
- Protection against phase reversal, phase imbalance & single phasing



BK1 DOL & Semi Automatic Star Delta Starters

- Range: DOL upto 7.5 H.P
- Range: Star Delta upto 15 H.P
- Wide Band Coil 250-400 V AC & 200-400 VAC



1-Phase DOL Starter

- Starter With 2 Pole CPGN Contactor and 2 Pole Overload Relay
- Encapsulated & Hermetically Sealed Coil
- Selection of Manual & Auto Resetting of Overload Relay
- Power Coated Deep Drwan Sheet Steel Enclosure for Excellent Finish & Durability



Mini Manual Starters

- Range Available upto 10 HP (3PH) & upto 3HP (1PH)
- Flush & Base Mounting Version Available
- Trips Automatically in Low Voltage Conditions (with UV Coil)
- Prevents Motor From Restarting When Powder Comes Back

BCH i-Pro

The intelligent upgrade for traditional motor starters



Smarter: Micro controller based protection design for advanced reliability and safety



Advanced: Digital voltmeter and ammeter for real-time, accurate monitoring



Powerful: Suitable for starters up to 40A, robust performance for demanding needs

ONE DEVICE **8** FUNCTIONS,
Save Cost, Space & Installation Time

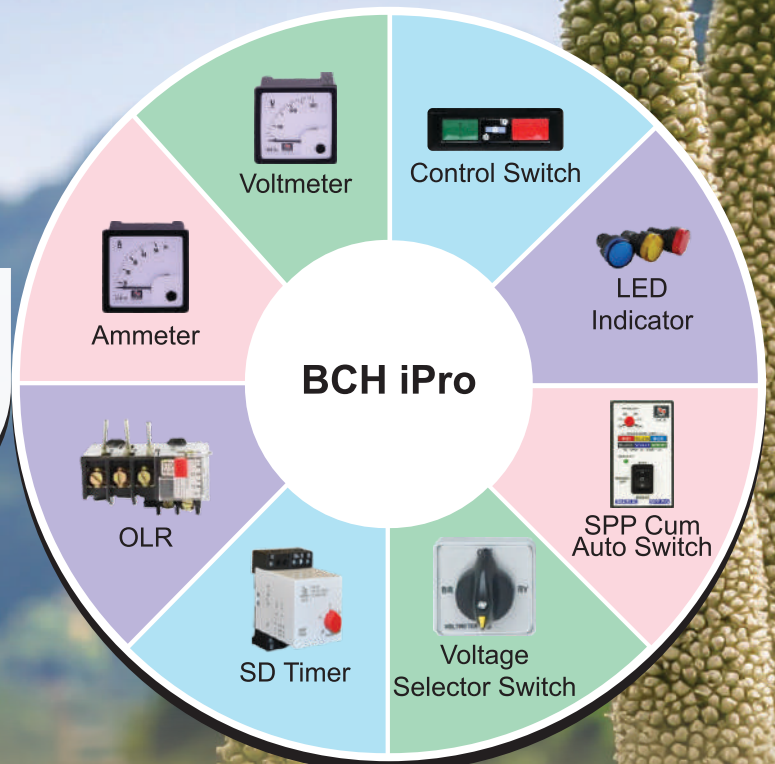

BCH
ELECTRIC
LIMITED

BCH MC range

Total pump control- Anytime, Anywhere

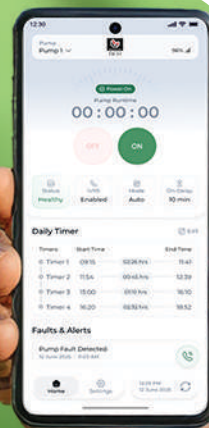

3in1
Smart Device:

SPP + Dry Run Protection + Mobile Controller = **BCH MC range**



Remote control & Monitoring

- Operate your pump from **anywhere, at any time.**
- Control via **SMS, Call, Mobile App or WhatsApp.**
- Accessible to all with **24 Local Language Support.**



Complete Motor Protection

- Safeguards against electrical faults: **Over/Under Voltage, Phase Loss, Phase Unbalance, and Phase Reversal.**
- Prevents damage with **Dry Run Protection.**



BCH
ELECTRIC
LIMITED

BCH Smart Controller

Total Protection, Connected Control



Protect your pump, Power your productivity



Smarter Water Management:

- **Digital Metering:** Monitor vital parameters like Voltage, Current, Power Factor, Power, and Energy Consumption directly from the device or app.
- **24 Local Language Support:** The companion app speaks your language, breaking down barriers and ensuring ease of use for everyone across the region.



Command Your Pump from Your Pocket:

- **Missed Call / IVRS:** No internet needed! Start/stop your pump with a simple missed call or interactive voice call.
- **SMS & Mobile App:** Get real-time status alerts and send commands via text or a user-friendly app.
- **WhatsApp Integration:** Receive notifications and send commands directly through the world's most popular messaging platform.



Never worry about pump failure again:

- Safeguards against electrical faults: **Over/Under Voltage, Phase Loss, Unbalance, and Reversal.**
- Prevents damage with **Dry Run Protection.**
- Secures your asset with **Anti-Theft Alerts.**



BCH
ELECTRIC
LIMITED

BK DOL

Powering an Uncompromising Rural India



1

Rugged, Corrosion-Resistant Enclosure

A heavy-duty powder-coated box that stands strong against rust and harsh weather, ensuring long-lasting performance

2

Superior Protection from Moisture

Features a modern, PVC-wrapped copper wire coil engineered to defeat damage from moisture, significantly extending the motor's lifespan

3

Built for Heavy-Duty Applications

A robust contact kit designed to handle high starting currents and torque loads with absolute reliability, making it perfect for demanding industrial and agricultural uses

4

Agriculture-Specific Overload Relay

An overload relay specifically crafted for farming conditions, offering unmatched protection against overload to prevent motor burnouts



BCH
ELECTRIC
LIMITED

BRAY Series

DOL Starters

Built Rugged, Driven by Reliability

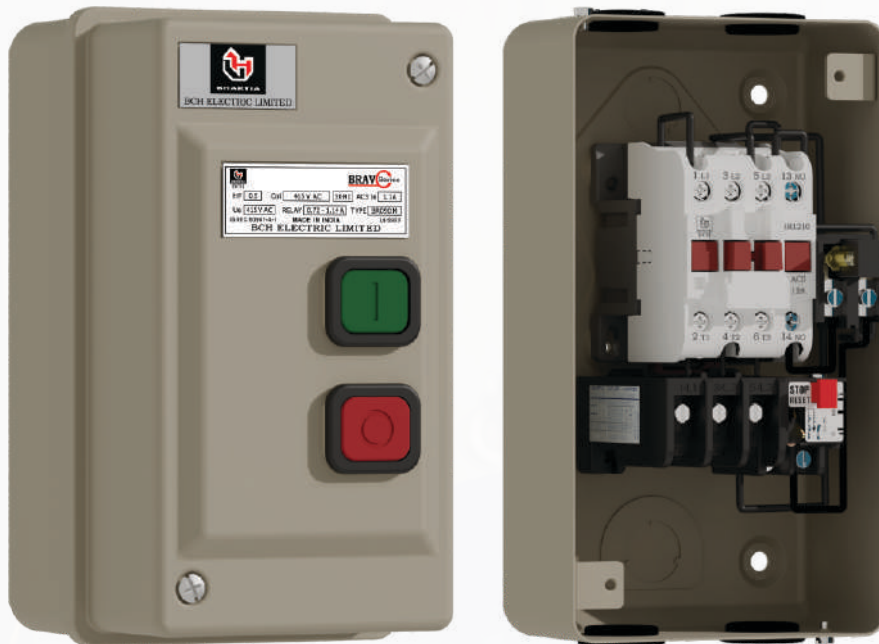

Versatile Application:

Perfect for small motors upto 10HP across various industries such as pumps, fan, machine tools etc.



Rugged & Proven:

Industrial-grade contactor built for harsh conditions



Reliable Protection:

Safeguards against overloads with best in class OLR and auto resetting



Simple to Use:

Easy installation and maintenance minimize downtime



BHARTIA

BCH

**BCH
ELECTRIC
LIMITED**

Nano+ Starter

Compact Power, Uncompromising Reliability



Integrated Motor Protection

A pre-assembled solution with built-in protections and monitoring that saves installation time and actively extends motor life



Built for Indian Conditions

A specialized **plastic enclosure** designed to withstand dust, moisture, and extreme temperatures



40% less space

Our radically compact design is a game-changer. Neater installation and easier maintenance



Unmatched Reliability

Equipped with a robust **NHD contactor** to ensure durability and long-term operation in harsh condition



BCH
ELECTRIC
LIMITED



Cat. No.	Overload Relay Range (A)	Contactor Type	Contactor Rating (AC-3)	MRP [₹]	Cat. No. (Open Execution)	MRP [₹]		
SAWPGZA	2.4 - 3.8	Shakti	12 A	3480	-	-		
SAWPHZA	3.8 - 6.0							
SAWPJZA	6.0 - 9.3							
SAWPGZ	2.4 - 3.8		20 A	3545	3515	SAWPGZI	3515	
SAWPHZ	3.8 - 6.0					SAWPHZI		
SAWPJZ	6.0 - 9.3					SAWPJZI		
SAWPKZ	8.9 - 13.5					SAWPKZI		
SAWPLZ	13.2 - 20.0					SAWPLZI		3710
SAWPMZ	17.4 - 24.0					SAWPMZI		3860

Shakti WP DOL Starter (Big Enclosure + TB)

HSN CODE : 8536

Cat. No.	Overload Relay Range (A)	Contactor Type	Contactor Rating (AC-3)	MRP [₹]
SAWPKZ-BT	8.9 - 13.5	Shakti	20 A	4670
SAWPLZ-BT	13.2 - 20.0			4860
SAWPMZ-BT	17.4 - 24.0			5120



Shakti DOL Starter (190-400V AC Coil)

HSN CODE : 8536

Cat. No.	Overload Relay Range (A)	Contactor Type	Contactor Rating (AC-3)	MRP [₹]	Cat. No. (Open Execution)	MRP [₹]
SAGZ	2.4 - 3.8	Shakti	20 A	3750	SAGZI	3720
SAHZ	3.8 - 6.0				SAHZI	
SAJZ	6.0 - 9.3				SAJZI	
SAKZ	8.9 - 13.5				SAKZI	
SALZ	13.2 - 20.0			SALZI	4060	
SAMZ	17.4 - 24.0			SAMZI	4225	



Shakti Auto-Start DOL Starter (With 5-Sec Delay Auto Switch)

3 Position Selection (Manual - Manual SPP - Auto)

HSN CODE : 8536

Cat. No.	Overload Relay Range(A)	Contactor Type	Contactor Rating (AC-3)	MRP [₹]
ASXGZ	2.4 - 3.8	Shakti	20 A	6190
ASXHZ	3.8 - 6.0			
ASXJZ	6.0 - 9.3			
ASXKZ	8.9 - 13.5			
ASXLZ	13.2 - 20.0			6495
ASXMZ	17.4 - 24.0			6870

For other Coil Voltages, kindly refer "Coil Voltage Master Table" at page 49

Shakti Semi Automatic Star Delta Starter with 260-400V AC Coil

HSN CODE : 8536



Cat. No.	Overload Relay Range (A)	Contactor Type	Contactor Rating (AC-3)	MRP [₹]
SASSGLEG	2.4 - 3.8	Shakti	16 A	12595
SASSHLEG	3.8 - 6.0			
SASSJLEG	6.0 - 9.3			
SASSKLEG	8.9 - 13.5			12850
SASSKLEG/LOR	13.2 - 20.0			
SASSKLEG-M	17.4 - 24.0			

Shakti Fully Automatic Star Delta Starter with 260-400V AC Coil & Electronic Timer

HSN CODE : 8536



Cat. No.	Overload Relay Range (A)	Contactor Type	Contactor Rating (AC-3)	MRP [₹]
SASAGLEG	2.4 - 3.8	Shakti	16 A	13865
SASAHLEG	3.8 - 6.0			
SASAJLEG	6.0 - 9.3			
SASAKLEG	8.9 - 13.5			14095
SASAKLEG/LOR	13.2 - 20.0			
SASAKLEG/MOR	17.4 - 24.0			

For 380 - 415 V Coil Voltage replace Suffix 'G' by 'N'



For other Coil Voltages, kindly refer "Coil Voltage Master Table" at page 49

Citation DOL Motor Starter

HSN CODE : 8536

Cat. No.	HP / KW at 3Ø, 415V, 50Hz	Overload Relay Range (A)	Contactor Type	Contactor Rating (AC-3)	MRP [₹]	Cat. No. (Open Execution)	MRP [₹]
NADLEN	0.5 / 0.37	0.72 - 1.14	C00N	16 A	4935	NADLENI	4800
NAELEN	0.75 / 0.55	1.07 - 1.70	C00N	16 A	4935	NAELENI	4800
NAFLEN	1 / 0.75	1.58 - 2.50	C00N	16 A	4935	NAFLENI	4800
NAGLEN	2 / 1.5	2.4 - 3.8	C00N	16 A	4935	NAGLENI	4800
NAHLEN	3 / 2.2	3.8 - 6.0	C00N	16 A	4935	NAHLENI	4800
NAJLEN	5 / 3.7	6.0 - 9.3	C00N	16 A	4935	NAJLENI	4800
NAKLEN	7.5 / 5.5	8.9 - 13.5	C00N	16 A	4935	NAKLENI	4800
NALLEN	10 / 7.5	13.2 - 20.0	C00N	16 A	5230	NALLENI	5090
NALLEN/CP20	10 / 7.5	13.2 - 20.0	CP20	20 A	5870		
NALLEN/MOR	12.5 / 10	17.4 - 24.0	CP20	20 A	6095	NALLENI/MOR	6100



Citation DOL Motor Starter (A) with NHD Contactor

HSN CODE : 8536

Cat. No.	HP / KW at 3Ø, 415V, 50Hz	Overload Relay Range (A)	Contactor Type	Contactor Rating (AC-3)	MRP [₹]
NAMLEN	15 / 11	17.4 - 24.0	N0N	25A	8210
NAMLEN/NOR	15 / 11	22.0 - 30.0	N0N	25A	8945
NAPLEN/MOR	15 / 11	17.4 - 24.0	N01N	32A	11095
NAPLEN	20 / 15	23.0 - 32.0	N01N	32A	11550
NANLEN	20 / 15	22.0 - 30.0	N1N	40A	12895
NAQLEN	25 / 18.5	26.0 - 40.0	N1N	40A	13090



(B) 30 & 40 HP DOL Starter

Cat. No.	HP / KW at 3Ø, 415V, 50Hz	Overload Relay Range (A)	Contactor Type	Contactor Rating (AC-3)	MRP [₹]
CEHFRGDM*	30 / 22	36.0 - 52.0 (FR OLR)	Freedom	50A	21720
NACT2LEDM	30 / 22	37.6 - 60.0	Citation D	40A	28775
NACT2LEEM	40 / 30	37.6 - 60.0	Citation E	70A	38320



Citation P DOL Motor Starter New

HSN CODE : 8536

Type	Cat. No.	Coil	HP/ KW at 3Ø, 415V, 50Hz	Overload Relay Range (A)	Contactor Rating (AC-3)	MRP [₹]
P2	NBMLEN/LOR	N & G	10 / 7.5	13.2 - 20	25A	6415
P2	NBMLEN	N & G	15 / 11	17.4 - 24	25A	6560
P2	NBMLEN/POR	N & G	15 / 11	23 - 32	25A	6870
P3	NBPLEN	N & WB	20 / 15	23 - 32	32A	8065
P3	NBPLEN/QOR	N & WB	20 / 15	26 - 40	32A	8370
P3H	NBQLEN	N & WB	25 / 18.5	26 - 40	40A	10245



Citation P Auto DOL Motor Starter New

HSN CODE : 8536

Type	Cat. No.	Coil	HP/ KW at 3Ø, 415V, 50Hz	Overload Relay Range (A)	Contactor Rating (AC-3)	MRP [₹]
P1A	ANBKLEN	N & G	7.5 / 5.5	8.9 - 13.5	16A	7060
P1A	ANBLEN	N & G	10 / 7.5	13.2 - 20	16A	7180
P1HA	ANBLEN/MOR	N & G	12.5 / 10	17.4 - 24	20A	7570
P1HA	ANBLEN/POR	N & G	12.5 / 10	23 - 32	20A	7790
P2A	ANBMLEN	N & G	12.5 / 10	17.4 - 24	25A	8620
P2A	ANBMLEN/POR	N & G	15 / 11	23 - 32	25A	8970
P3A	ANBPLEN	N & WB	20 / 15	26 - 40	32A	9750
P3A	ANBMLEN/QOR	N & WB	20 / 15	26 - 40	32A	9860
P3HA	ANBQLEN	N & WB	22.5 / 16.8	26 - 40	40A	11395



For other Coil Voltages, kindly refer 'Coil Voltage Master Table' at page 49

Citation Semi Automatic Star Delta Starter with NHD Contactor

HSN CODE : 8536



Cat. No.	HP / kW at 3Ø, 415V, 50Hz	Overload Relay Range (A)	Contactor Type	Contactor Rating (AC-3)	MRP [₹]
NASSHLEN	10 / 7.5	6.0 - 9.3	C00N	16A	13565
NASSJLEN	10 / 7.5	6.0 - 9.3	C00N	16A	13565
NASSKLEN	15 / 11	8.9 - 13.5	C00N	16A	13565
NASSKLEN/LOR	15 / 11	13.2 - 20.0	C00N	16A	13990
NASSLLEN	20 / 15	13.2 - 20.0	N0N	25A	21485
NASSMLEN	25 / 18.5	17.4 - 24.0	N0N	25A	21620
NASSPLEN	25 / 18.5	23.0 - 32.0	N0N	25A	23900
NASS01PLEN	35 / 26	23.0 - 32.0	N01N	32A	27655
NASS01QLEN	40 / 30	26.0 - 40.0	N01N	32A	27900
NASSNLEN	35 / 26	22.0 - 30.0	N1N	40A	40470
NASS01CT1LEN	40 / 30	24.4 - 39.0	N01N	32A	39050
NASSFRGCLEC4M	40 / 30	29-42 (FR OLR)	C4	32A	42145

Citation Fully Automatic Star Delta Starter with NHD Contactor & Pneumatic Timers

HSN CODE : 8536



Cat. No.	HP / KW at 3Ø, 415V, 50Hz	Overload Relay Range (A)	Contactor Type	Contactor Rating (AC-3)	MRP [₹]
NASAGLEN	3 / 2.2	2.4 - 3.8	C00N	16A	18665
NASAHLEN	5 / 3.7	3.8 - 6.0	C00N	16A	18665
NASAJLEN	10 / 7.5	6.0 - 9.3	C00N	16A	18665
NASAKLEN	15 / 11	8.9 - 13.5	C00N	16A	18665
NASAKLEN/LOR	15 / 11	13.2 - 20.0	C00N	16A	19570
NASALLEN	20 / 15	13.2 - 20.0	N0N	25A	24600
NASAMLEN	25 / 18.5	17.4 - 24.0	N0N	25A	24735
NASAPLEN	30 / 22	23.0 - 32.0	N0N	25A	25760
NASA01PLEN	35 / 26	23.0 - 32.0	N01N	32A	32780
NASANLEN	35 / 26	22.0 - 30.0	N1N	40A	46525
NASAQLEN	40 / 30	26.0 - 40.0	N1N	40A	46795
NASACT1LEN	40 / 30	24.4 - 39.0	N1N	40A	50390

Citation Fully Automatic Star Delta Starter with Citation M Contactor & Pneumatic Timers

HSN CODE : 8536



Cat. No.	HP / KW at 3Ø, 415V, 50Hz	Overload Relay Range (A)	Contactor Type	Contactor Rating (AC-3)	MRP [₹]
NASACT1LEDM	40 / 30	24.4 - 39.0	D	40A	59855
NASACT2LEDM	50 / 37	37.6 - 60.0	D	40A	60810
NASACT2LEEM	75 / 55	37.6 - 60.0	E	70A	104000
NASACT3LEEM	85 / 65	56.4 - 90.0	E	70A	111125
NASACT3LEC5M	100 / 75	56.4 - 90.0	M-5	110A	143900
NASACT4LEC5M	135 / 100	84.6 - 135.0	M-5	110A	147125
NASACT4LENM	150 / 110	84.6 - 135.0	N	140A	202830
NASACT5LEC6M	250 / 185	131.6 - 210.0	S	300A	279615
NASACT6LEC6M	375 / 280	188.0 - 300.0	S	300A	337695

For other Coil Voltages, kindly refer 'Coil Voltage Master Table' at page 49

Motor Starters-BK1

New



BK1 DOL Motor Starter

HSN CODE : 8536

Type	Cat. No.	HP/ KW at 3Ø, 415V, 50Hz	Overload Relay Range (A)	Contactor Rating (AC-3)	MRP [₹]
BK1 DOL	BK1DBEWB1	0.75 HP	1-1.6	16A	2845
BK1 DOL	BK1DBFWB1	1 HP	1.5-2.5	16A	2845
BK1 DOL	BK1DBGWB1	2 HP	2.5-4	16A	2845
BK1 DOL	BK1DBHWB1	4 HP	4-6.5	16A	2845
BK1 DOL	BK1DBJWB1	6 HP	6-10	16A	2845
BK1 DOL	BK1DBKWB1	7.5 HP	9-14	16A	2845
BK1 DOL	BK1DBKLWB1	7.5 HP	11-18	16A	2905
BK1 DOL	BK1DBLWB1	7.5 HP	13-22	16A	2980
Bk2 DOL	BK2DBKWB1	7.5 HP	9-14	25A	3510
Bk2 DOL	BK2DBKLWB1	7.5 HP	11-18	25A	3510
BK2 DOL	BK2DBLWB1	7.5 HP	13-22	25A	3510
BK2 DOL	BK2DBPWB1	7.5 HP	20-32	25A	3510

*WB1 - 250-450V (415V) *WB2 - 200-400V (360V)

BK1 Semi-Automatic Motor Starter

HSN CODE : 8536

Type	Cat. No.	HP/ KW at 3Ø, 415V, 50Hz	Overload Relay Range (A)	Contactor Rating (AC-3)	MRP [₹]
BK1 SASD	BK1SSBHWB1	6 HP	4-6.5	16A	10975
BK1 SASD	BK1SSBJWB1	10 HP	6-10	16A	10975
BK1 SASD	BK1SSBKWB1	12.5 HP	9-14	16A	10975
BK1 SASD	BK1SSBKLBW1	15 HP	11-18	16A	11060
BK1 SASD	BK1SSBLWB1	15 HP	13-22	16A	11195
BK2 SASD	BK2SSBLWB1	15 HP	13-22	25A	12295
BK2 SASD	BK2SSBPWB1	15 HP	20-32	25A	12295

BK Contactors

HSN CODE : 8536

Cat. No.	Description	MRP [₹]
BK1C16WB1	Bk1 Contactor, 4P, 16A, 250-450V AC	2110
BK2C25WB1	BK2 Contactor, 4P, 25A, 250-450V AC	2415

BK Overload Relay

HSN CODE : 8536

Cat. No.	Description	MRP [₹]
BK1OLRBE	Overload Relay, 3P, BK, 1-1.6A	1165
BK1OLRBF	Overload Relay, 3P, BK, 1.5-2.5A	1165
BK1OLRBG	Overload Relay, 3P, BK, 2.5-4.0A	1165
BK1OLRBH	Overload Relay, 3P, BK, 4-6A	1165
BK1OLRBJ	Overload Relay, 3P, BK, 6-10A	1165
BK1OLRBK	Overload Relay, 3P, BK, 9-14A	1165
BK1OLRBKL	Overload Relay, 3P, BK, 11-18A	1200
BK1OLRBL	Overload Relay, 3P, BK, 13-22A	1340
BK2OLRBP	Overload Relay, 3P, BK, 20-32A	1490

Spares for BK1 Starters

HSN CODE : 8538

Cat. No.	Description	MRP [₹]
BK1-AS16	Housing (Arc Shield) for BK1 Contactor	165
BK2-AS25	Housing (Arc Shield) for BK2 Contactor	170
BK1-CB16	Contact Bridge for BK1 Contactor	150
BK2-CB25	Contact Bridge for BK2 Contactor	165
BK1-CK16	Contact Kit for BK1 Contactor	960
BK2-CK25	Contact Kit for BK2 Contactor	1355
BKCWB1	Coil 250-450V AC for BK Contactors	320
BKCWB2	Coil 200-400V AC for BK Contactors	320
BK-PB	Twin Push Button for BK Starters	150
BKCB11	Auxiliary contact 1NO+1NC for BK Starter	330
BK1-MC16	Single moving contact for BK1 Contactor	95
BK2-MC25	Single moving contact for BK2 Contactor	130



Fully Automatic Star Delta Starter with Citation M Contactor, Pneumatic Timer & Electronic Over Current Relay with Ammeter & Voltmeter

HSN CODE : 8536



Cat. No.	HP / KW at 3Ø, 415V, 50Hz	EOCR Range (A)	Contactor Type (Citation)	Contactor Rating (AC-3)	MRP [₹]
NASASS60LEDM-P	50 / 37	5-60 Amp	D	40A	72210
NASASS60LEEM-P	75 / 55	5-60 Amp	E	70A	115125
NASA2CTD1CLEM5M-P	100/ 75	0.5-6 Amp (with CT 100/5) (2CT model)	M-5	110A	157065
NASA2CT150LEM5M-P	135/ 100	0.5-6 Amp (with CT 150/5) (2CT model)	M-5	110A	162706

Fully Automatic Star Delta Starter with NHD Contactor, Electronic Timer & Electronic Over Current Relay with Ammeter & Voltmeter and MCB

HSN CODE : 8536

Cat. No.	HP / KW at 3Ø, 415V, 50Hz	EOCR Range (A)	Contactor Type (NHD)	Contactor Rating (AC-3)	MCB Rating	MRP [₹]
NASASS30LEN-P-MCB	25 / 18.5	3-30 Amp	NA25M	25A	40A (TP)	42830

Motor Starters- Freedom

Industrial DOL Starters with Freedom Contactor & Overload Relay

HSN CODE : 8536



Cat. No.	HP / KW at 3Ø, 415V, 50Hz	Overload Relay Type	Overload Relay Range (A)	Contactor Type	Contactor Rating (AC-3)	MRP [₹]
CEBFM	0.5/0.37	Freedom	1.0-1.4	Freedom	9 A	3615
CEBGM	0.75/0.55	Freedom	1.3-1.8	Freedom	9 A	3615
CEBHM	1.0/0.75	Freedom	1.7-2.4	Freedom	9 A	3615
CEBJM	1.5/1.1	Freedom	2.2-3.1	Freedom	9 A	3615
CEBKM	2.0/1.5	Freedom	2.8-4.0	Freedom	9 A	3615
CEBMM	3.0/2.2	Freedom	4.5-6.5	Freedom	9 A	3615
CEBPM	5.0/3.7	Freedom	7.5-11	Freedom	9 A	3615
CECPM	5.0/3.7	Freedom	7.5-11	Freedom	12 A	3715
CECQM	7.5/5.5	Freedom	10-14	Freedom	12 A	3715
CEDQM	7.5/5.5	Freedom	10-14	Freedom	18 A	4690
CEDRM	10/7.5	Freedom	13-19	Freedom	18 A	4690
CECBHM	3.0/2.2	Citation	3.8-6	Freedom	9 A	3615
CECBJM	5.0/3.7	Citation	6-9.3	Freedom	9 A	3615
CECCKM	7.5/5.5	Citation	8.9-13.5	Freedom	12 A	3715
CECDLM	10/7.5	Citation	13.2-20	Freedom	18 A	4690

DOL Reversing Starter

HSN CODE : 8536



Cat. No.	HP / KW at 3Ø, 415V, 50Hz	Overload Relay Range (A)	Contactor Type	Contactor Rating (AC-3)	MRP [₹]
NARFLEN	1/0.75	1.58 - 2.50	C00N	16 A	12070
NARGLEN	2/1.5	2.4 - 3.8	C00N	16 A	12070
NARHLEN	3/2.2	3.8 - 6.0	C00N	16 A	12070
NARJLEN	5/3.7	6.0 - 9.3	C00N	16 A	12070
NARKLEN	7.5/5.5	8.9 - 13.5	C00N	16 A	12070
NARLLEN	10/7.5	13.2 - 20.0	N0N	25 A	16930
NARMLLEN	15/11	17.4 - 24.0	N1N	40 A	22700
NARNLEN	20/15	22.0 - 30.0	N1N	40 A	23970

For other Coil Voltages, kindly refer 'Coil Voltage Master Table' at page 49

1- Phase Mini Manual Motor Starter upto 3HP (Surface Mounting)

HSN CODE : 8536



Cat. No.	Recommended HP 1Ø, 240V	Overload Relay Range (A)	MRP [₹]	Cat. No. (with UV Coil)	MRP [₹]
AMLE-10-SP	-	0.23 - 0.47	1930	AMLEH-10-SP	2470
AMLE-20-SP	-	0.46 - 0.80		AMLEH-20-SP	
AMLE-30-SP	1 / 8	0.85 - 1.55		AMLEH-30-SP	
AMLE-40-SP	1 / 6	1.60 - 3.20		AMLEH-40-SP	
AMLE-50-SP	0.5 / 0.75	3.50 - 6.50		AMLEH-50-SP	
AMLE-60-SP	1 to 2	6.80 - 11.7		AMLEH-60-SP	
AMLE-70-SP	2 to 3	11.0 - 20.0		AMLEH-70-SP	

For flush mounting replace 'E' by 'C' and reduce price by ₹50

3- Phase Mini Manual Motor Starter upto 10 HP (Surface Mounting)

HSN CODE : 8536



Cat. No.	Recommended HP 3Ø, 415V	Overload Relay Range (A)	MRP [₹]	Cat. No. (with UV Coil)	MRP [₹]
AMLE-10	-	0.23 - 0.47	2600	AMLEN-10	2860
AMLE-20	-	0.46 - 0.80		AMLEN-20	
AMLE-30	0.50 / 0.75	0.85 - 1.55		AMLEN-30	
AMLE-40	1.00 / 1.50	1.60 - 3.20		AMLEN-40	
AMLE-50	3.00	3.50 - 6.50		AMLEN-50	
AMLE-60	5.00	6.80 - 11.7		AMLEN-60	
AMLE-70	10.00	11.0 - 20.0		AMLEN-70	

For flush mounting replace 'E' by 'C' and reduce price by ₹50

1-Phase DOL with 2P Contactor & 2P Overload Relay New

HSN CODE : 8536



Type	Cat. No.	HP/ KW at 1Ø, 220V, 50Hz	Overload Relay Range (A)	Contactor Rating (AC-3)	MRP [₹]
1P10	NAHLEBW-SP	0.75 / 0.55	3.8 - 6.0	16A	2640
1P10	NAJLEBW-SP	1 / 0.75	6.0 - 9.3	16A	2640
1P10	NAKLEBW-SP	1.5 / 1.10	8.9 - 13.5	16A	2640
1P10H	NALLEBW-SP	2 / 1.5	13.2 - 20	25A	2690
1P10H	NAMLEBW-SP	3 / 2.2	17.4 - 24	25A	2770

Manual Star Delta Starter (with 260-400V AC Coil)

HSN CODE : 8536



Cat. No.	HP at 3Ø, 415V, 50Hz	Overload Relay Range (A)	Contactor Type	Contactor Rating (AC-3)	MRP [₹]
HASSGLEG	3 HP	2.4 - 3.8	C00N	16 A	7745
HASSHLEG	5 HP	3.8 - 6.0	C00N	16 A	7745
HASSJLEG	10 HP	6.0 - 9.3	C00N	16 A	7745
HASSKLEG	15 HP	8.9 - 13.5	NON	25 A	8800

HSN CODE : 8538

HASSW15	Spare switch for 15 HP MSD Starter			2985
---------	------------------------------------	--	--	------

For other Coil Voltages, kindly refer 'Coil Voltage Master Table' at page 49



Three Phase

- Direct on line : upto 40 A relay rating
- Star Delta : upto 135 A relay rating
- Protections :
 - Phase failure
 - Phase imbalance
 - Phase reversal
- Short Circuit Protection Through MCB/MCCB : In case of Premium models
- Auto Start with on delay options:
 - 0.5Sec to 5Min (Field adjustable) SPP Pro
 - 5Sec
 - 5Min
- Ammeter and Voltmeter
- On/Off and Trip indications
- Powder coated enclosure with PU gasket ensuring excellent finish and reliability
- Provision for connecting Dry run preventor



On/Trip Indicators



Isolated Terminal blocks for better termination



Better esthetic look & easy to maintenance to use of Bus-bar

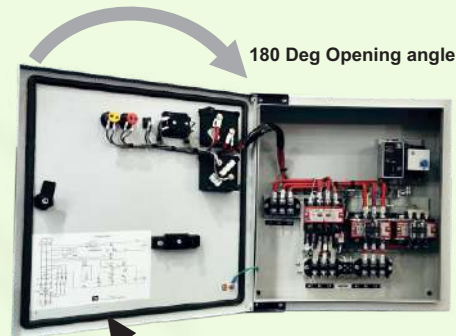

180 Deg Opening angle

PU Gasket for excellent sealing against dust & water



Single Phase

With Mini DOL (up to 11 - 20 A Relay)

- Premium Model (With Ammeter & Voltmeter)

With 2 Pole Contactor + 2 Pole Relay (up to 40 A Relay)

- Economy Model (With Ammeter)
- Standard Model (With Ammeter & Voltmeter)
- Alfa Model up to 30 A Relay (With Ammeter & Voltmeter)
- With Dry Run Protection Model (Digital Meter)
- CPD Model with MCB (Digital VA Meter)

Citation Submersible Pump Starter with 3-Position Selection (with Auto Switch) with or without MCB option

DOL (3-Ph)

HSN CODE : 8536



Overload Relay Range (A)	Contactor Type	Contactor Rating (AC-3)	DOL (without Short Circuit Protection)		Premium DOL (with Short Circuit Protection) MCB		MCB "C" 10kA
			Cat. No.	MRP [₹]	Cat. No.	MRP [₹]	
1.58 - 2.50	C00N	16 A	CPEYNAFN	10915	--	--	--
2.4 - 3.8	C00N	16 A	CPEYNAGN	10915	CPPYNAGN	16050	6A
3.8 - 6.0	C00N	16 A	CPEYNAHN	10915	CPPYNAHN	16050	10A
6.0 - 9.3	C00N	16 A	CPEYNAJN	10915	CPPYNAJN	16050	16A
8.9 - 13.5	C00N	16 A	CPEYNAKN	10915	CPPYNAKN	16050	25A
13.2 - 20.0	C00N	16 A	CPEYNALN	11825	CPPYNALN	17170	32A
17.4 - 24.0	N0N	25 A	CPEYNAMN	13155	CPPYNAMN	19545	40A
23.0 - 32.0	N01N	32 A	CPEYNA01PN	14705	--	--	--

Citation Submersible Pump Starter with 3-Position Selection (with Auto Switch) with or without MCB / MCCB option

STAR DELTA (3-Ph)

HSN CODE : 8536



Overload Relay Range (A)	Contactor Type	Contactor Rating (AC-3)	Star Delta (without Short Circuit Protection)		Premium Star Delta (with Short Circuit Protection) MCB or MCCB		*MCB "C" 10kA/ MCCB
			Cat. No.	MRP [₹]	Cat. No.	MRP [₹]	
3.8 - 6.0	C00N	16 A	CPSDEYHN	21425	--	--	--
6.0 - 9.3	C00N	16 A	CPSDEYJN	21425	CPSPYJN	26185	32A
8.9 - 13.5	C00N	16 A	CPSDEYKN	21425	CPSPYKN	26185	40A
13.2 - 20.0	C00N	16 A	CPSDEYLN-C00	21810	CPSPYLN-C00	27185	50A
17.4 - 24.0	CP20	20 A	CPSDEYMN-CP20	23845	--	--	--
13.2 - 20.0	N0N	25 A	CPSDEYLN	26390	CPSPYLN	32165	50A
17.4 - 24.0	N0N	25 A	CPSDEYMN	27800	CPSPYMN	34755	63A
23.0 - 32.0	N01N	32 A	CPSDEY01PN	34880	CPSPY01N	40315	63A
22.0 - 30.0	N1N	40 A	CPSDEYNN	44810	CPSPYNN	49715	80A/10kA
26.0 - 40.0	N1N	40 A	CPSDEYQN	45465	CPSPYQN	50405	80A/10kA
24.4 - 39.0	N1N	40 A	CPSDEYCT1N	51525	CPSPYCT1N	59795	100A/10kA
37.6 - 60.0	Citation E	70 A	CPSDEYCT2M	83075	CPSPYCT2M	92635	125A/10kA
56.4 - 90.0	Citation E	70 A	CPSDEYCT3M	89170	CPSPYCT3M	95020	125A/10kA
56.4 - 90.0	Citation M-5	110 A	CPSDEYCT3M	118610	CPSPYCT3M	125685	125A/ 36/18kA
84.6 - 135.0	Citation M-5	110 A	CPSDEYCT4M	122355	CPSPYCT4M	134930	200A/ 36/18kA

*Upto 63A MCB & 80A onwards MCCB are used

Shakti DOL Submersible Pump Starter (with Auto Switch) 3-Ph

HSN CODE : 8536



Overload Relay Range (A)	Description	Contactor Rating (AC-3)	3 Position Selection (Manual - Manual SPP - Auto)	
	Contactor Type		Cat. No.	MRP [₹]
2.4 - 3.8	Shakti	20 A	CPEYSAGZ	10250
3.8 - 6.0	Shakti	20 A	CPEYSAHZ	10250
6.0 - 9.3	Shakti	20 A	CPEYSAJZ	10250
8.9 - 13.5	Shakti	20 A	CPEYSAKZ	10250
13.2 - 20.0	Shakti	20 A	CPEYSALZ	11335
17.4 - 24.0	Shakti	20 A	CPEYSAMZ	11925

For 380 - 415 V coil voltage replace suffix "Z" with "N" in the Cat. Code

For other Coil Voltages, kindly refer 'Coil Voltage Master Table' at page 49

Motor Starters-Citation P & Shakti P



Citation P Submersible Pump Starter - Standard and Premium versions

DOL (3-Ph)

HSN CODE : 8536



Type	Overload Relay Range (A)	Contactor Rating (AC-3)	Coil	Standard (without Short Circuit Protection)		Premium (with Short Circuit Protection with MCB)		MCB "C" 10kA
				Cat. No.	MRP [₹]	Cat. No.	MRP [₹]	
CITATION P10	1.58 - 2.5	16 A	N & G	CPEYNBFN	10140	CPPYNBFN	12950	10A
CITATION P10	2.4 - 3.8	16 A	N & G	CPEYNBGN	10140	CPPYNBGN	12950	10A
CITATION P10	3.8 - 6	16 A	N & G	CPEYNBHN	10140	CPPYNBHN	12950	10A
CITATION P10	6 - 9.3	16 A	N & G	CPEYNBJN	10140	CPPYNBJN	13000	16A
CITATION P10	8.9 - 13.5	16 A	N & G	CPEYNBKN	10280	CPPYNBKN	13000	25A
CITATION P10	13.2 - 20	16 A	N & G	CPEYNBLN	10585	CPPYNBLN	13595	32A
CITATION P10B	13.2 - 20	20 A	N & G	CPEYNBL2N	10740	CPPYNBL2N	14010	40A
CITATION P10H	17.4 - 24	25 A	N & G	CPEYNBMN	11180	CPPYNBMN	14580	40A
CITATION P10H	23 - 32	25 A	N & G	CPEYNBPN	11935	CPPYNBPN	15350	50A
CITATION P11	23 - 32	32A	N & WB	CPEYNBP01N	12680	CPPYNBP01N	16305	63A
CITATION P11	26 - 40	32A	N & WB	CPEYNBQ01N	12855	CPPYNBQ01N	16460	63A
CITATION P12	26 - 40	40A	N & WB	CPEYNBQN	13810	CPPYNBQN	17085	63A

For spare contactor refer page 13

Citation P Submersible Pump Starter - Standard and Premium versions

STAR DELTA (3-Ph)

HSN CODE : 8536



Type	Overload Relay Range (A)	Contactor Rating (AC-3)	Coil	Standard (without Short Circuit Protection)		Premium (with Short Circuit Protection with MCB/MCCB)		*MCB "C" 10kA/ MCCB
				Cat. No.	MRP [₹]	Cat. No.	MRP [₹]	
CITATION P20	6 - 9.3	16 A	N & G	CPSDEYNBJN	20045	CPSDPYNBJN	21900	32A
CITATION P20	8.9 - 13.5	16 A	N & G	CPSDEYNBKN	20045	CPSDPYNBKN	22460	40A
CITATION P20	13 - 20	16 A	N & G	CPSDEYNBLN	20670	CPSDPYNBLN	22625	50A
CITATION P20A	13.2 - 20	20 A	N, LV & G	CPSDEYNBL2N	21595	CPSDPYNBL2N	24775	63A
CITATION P20A	17.4 - 24	20 A	N, LV & G	CPSDEYNBM2N	21610	CPSDPYNBM2N	24910	63A
CITATION P20B	23 - 32A	25 A	N, LV & G	CPSDEYNBPN	25355	CPSDPYNBPN	29875	63A
CITATION P20H	22 - 30A	32 A	N & WB	CPSDEYNB01NN	25955	CPSDPYNB01NN	29975	63A
CITATION P20H	23 - 32A	32 A	N & WB	CPSDEYNB01PN	25970	CPSDPYNB01PN	30560	63A
CITATION P20H	26 - 40A	32 A	N & WB	CPSDEYNB01QN	26745	CPSDPYNB01QN	33200	80A/10kA
CITATION P21	26 - 40A	40 A	N & WB	CPSDEYNBQN	33725	CPSDPYNBQN	41260	80A/10kA
CITATION P21	36 - 52A (FR OLR)	40 A	N & WB	CPSDEYNBFRGDN	39420	-	-	-

*Upto 63A MCB & 80A onwards MCCB are used

Range Extension



Type	Overload Relay Range (A) (Freedom OLR)	Contactor Rating (AC-3) (Citation 3P)	Cat. No.	Coil	MRP [₹]
Citation P32	22 - 32	32 Amp	CPSDEYNBC4FRGBM	M	40140
Citation P40	36 - 52	40 Amp	CPSDEYNBDFRGDM	M	41190
Citation P50	45 - 63	50 Amp	CPSDEYNBD1FRGEM	M	49620
Citation P70	36 - 52	70 Amp	CPSDEYNBEFRGDM	M & LA	68255
Citation P70	45 - 63	70 Amp	CPSDEYNBEFRGEM	M & LA	70305
Citation P70	60 - 80	70 Amp	CPSDEYNBEFRGFM	M & LA	72695
Citation P100	60 - 80	110 Amp	CPSDEYNBM5FRGFM	M & LA	93150

For spare contactor refer page 49

Shakti P DOL Submersible Pump Starter (3-Phase)

HSN CODE : 8536



Type	Overload Relay Range (A)	Contactor Rating (AC-3)	Cat. No.	Coil	MRP [₹]
SHAKTI P6	1.58 - 2.5	12 A	CPEYSBFZ	Z & N & MB	9485
SHAKTI P6	2.4 - 3.8		CPEYSBGZ		
SHAKTI P6	3.8 - 6		CPEYSBHZ		
SHAKTI P6	6 - 9.3		CPEYSBJZ		
SHAKTI P10	8.9 - 13.5	20 A	CPEYSBKZ		9625
SHAKTI P10	13.2 - 20		CPEYSBLZ		10565
SHAKTI P10	17.4 - 24		CPEYSBMZ		11115

*For spare Contactor refer page 19

1-Phase DOL with 2P CPG Contactor & 2P Overload Relay

HSN CODE : 8536



Cat. No.	HP / KW at 1Ø, 220V, 50Hz	Overload Relay Range (A)	Contactor Type	Contactor Rating (AC-3)	MRP [₹]
NAAEBW-SP	-	1.07 - 1.70	2P CPG	12A	3555
NAAHBW-SP	0.75 / 0.55	3.8 - 6.0	2P CPG	12A	3555
NAHBW-SP	0.75 / 0.55	3.8 - 6.0	2P CPG	16A	3625
NAAJBW-SP	1 / 0.75	6.0 - 9.3	2P CPG	12A	3555
NAJBW-SP	1 / 0.75	6.0 - 9.3	2P CPG	16A	3625
NAKBW-SP	1.5 / 1.10	8.9 - 13.5	2P CPG	16A	3625
NAALBW-SP	2 / 1.5	13.2 - 20.0	2P CPG	20A	3720
NALBW-SP	2 / 1.5	13.2 - 20.0	2P CPG	25A	4055
NAMBW-SP	3 / 2.2	17.4 - 24.0	2P CPG	25A	4235

Auto Switch Cum SPP (SPP pro)



- Two type of versions : 6-wire and 7-wire
- Microcontroller based design for advanced functionality
- Protection against single phasing, reverse phasing and unbalance voltage
- Settable ON delay time - 5 Sec to 5 Min
- Integrated Auto/ Manual SPP/ Bypass switch
- LED indication :
 - Healthy Supply Conditions: Green LED is continuous ON
 - Unhealthy Supply Conditions: Green LED is blinking

HSN CODE : 8538

Cat. No.	Cat. No. (For BK Starters)	Description	MRP[₹]
BCHSPP2Z	BCHSPP2BKZ	SPP Pro (6 wire), 230-400V AC	1015
BCHSPP2N	BCHSPP2BKN	SPP Pro (6 wire), 380-415V AC	1015
BCHSPP2CW	BCHSPP2BKCW	SPP Pro (6 wire), 260-440V AC	1015
BCHSPP2Z-7W	BCHSPP2BKZ-7W	SPP Pro (7 wire), 230-400V AC	1015
BCHSPP2N-7W	BCHSPP2BKN-7W	SPP Pro (7 wire), 380-415V AC	1015
BCHSPP2CW-7W	BCHSPP2BKCW-7W	SPP Pro (7 wire), 260-440V AC	1015

Motor Starters-1-Ph SPS

1-Phase SPS With 2P Contactor + Overload Relay (Ammeter + Voltmeter) with 160-220V AC Coil

HSN CODE : 8536



HP at 1Ø, 220V, 50Hz	Overload Relay Range (A)	Contactor Rating (AC-3)	Cat. No.	Run Capacitor (mfd)	Start Capacitor (mfd)	MRP [₹]
0.75 HP	3.8 - 6.0	12 Amp	CPNSHBW-SPE	25	80/100	5865
0.75 HP	3.8 - 6.0	16 Amp	CPNSHBW-SP	25	80/100	5940
			CPNSHBW-SP(RC36)	36	80/100	5990
			CPNSHBW-RC25-SC120	25	100/120	6130
			CPNSHBW-RC30-SC200	30	150/200	6935
1 HP	6.0 - 9.3	12 Amp	CPNSJBW-SPE	36	100/120	6095
1 HP	6.0 - 9.3	16 Amp	CPNSJBW-SP	36	100/120	6135
			CPNSJBW-RC20SC100	20	80/100	6100
			CPNSJBW-RC25SC100	25	80/100	6185
			CPNSJBW-RC50SC100	50	80/100	6365
			CPNSJBW-RC60SC150	60	120/150	6660
			CPNSJBW-RC72SC150	72	120/150	6805
			CPNSJBW-SP(RC30)	30	100/120	6185
			CPNSJBW-SP(RC50)	50	100/120	6185
			CPNSJBW-SP(SC100)	36	80/100	6610
			CPNSJBW-RC36-SC200	36	150/200	7065
1.5 HP	8.9 - 13.5	12 Amp	CPNSKBW-SPE	50	120/150	6705
1.5 HP	8.9 - 13.5	16 Amp	CPNSKBW-SP	50	120/150	6695
			CPNSKBW-RC30SC120	30	100/120	6600
			CPNSKBW-RC36SC120	36	100/120	6620
			CPNSKBW-SP(RC36)	36	120/150	6660
			CPNSKBW-SP(RC72)	36+36	120/150	6870
CPNSKBW-RC50-SC200	50	150/200	7325			
2 HP	13.2 - 20.0	16 Amp	CPNSLBW-SP	72	150/200	7165
			CPNSLBW-SP(2RC36)	36+36	150/200	7345
			CPNSLBW-RC100SC150	100	120/150	7220
			CPNSLBW-RC90SC150	45+45	120/150	7355
			CPNSLBW-SP(SC150)	72	120/150	7355
CPNSLBW-RC72SC250	72	200/250	7760			
3 HP	17.4 - 24.0	20 Amp	CPNSMBW-SPE	100	200/250	7705
3 HP	17.4 - 24.0	25 Amp	CPNSMBW-SP	100	200/250	7965
			CPNSMBW-SP(2RC50)	50+50	200/250	8275
3 HP	22.0 - 30.0	25 Amp	CPNSNBW-SP	100	200/250	8520
			CPNSNBW-SP(2RC50)	50+50	200/250	8760
5 HP	23.0 - 32.0	32 A & 12 A	CPNSPBW-SPE	100+50	200/250	11855
5 HP	23.0 - 32.0	40 A & 16 A	CPNSPBW-SP	100+50	200/250	11930
			CPNSPBW-SP(3RC50)	50+50+50	200/250	12215
5 HP	23.0 - 32.0	40 Amp	New CPNSPBW-SPH	100+50	200/250	10230
			CPNSPBBW-SPH	100+50	200/250	10230
			CPNSPBW-SPH(3R50)	50+50+50	200/250	10230
			CPNSPBBW-SPH(3R50)	50+50+50	200/250	10230
5 HP	28.0 - 40.0	40 Amp	New CPNSQBBW-SPH	100+50	200/250	10750
			CPNSQBW-SPH	100+50	200/250	10750
			CPNSQBBW-SPH(3R50)	50+50+50	200/250	10750
			CPNSQBW-SPH(3R50)	50+50+50	200/250	10750

*Suffix "D" in Cat Code for Dry Run Protection panel (only Extra Terminal is provided to connect Dry Run unit)

**For 170-240V coil, replace "BW" in above cat code with "BBW"

1-Phase SPS (Alfa Model) With 2P Contactor + Overload Relay (Ammeter + Voltmeter)

HSN CODE : 8536



HP at 1Ø, 220V, 50Hz	Overload Relay Range (A)	Contactor Rating (AC-3)	Cat. No.	Run Capacitor (mfd)	Start Capacitor (mfd)	MRP [₹]
0.75 HP	3.8 - 6	16 Amp	CPGNSHBW-SP	25	80-100	5045
1 HP	6 - 9.3	16 Amp	CPGNSJBW-SP	36	100-120	5430
1 HP	6 - 9.3	16 Amp	CPGNSJBBW-SP	36	100-120	5430
1 HP	6 - 9.3	16 Amp	CPGNSJBW-SP(RC50)	50	100-120	5430
1 HP	6 - 9.3	16 Amp	CPGNSJBBW-SP(RC50)	50	100-120	5430
1 HP	6 - 9.3	16 Amp	CPGNSJBW-RC50SC100	50	80-100	5430
1.5 HP	8.9 - 13.5	16 Amp	CPGNKSBW-SP	50	120-150	5845
1.5 HP	8.9 - 13.5	16 Amp	CPGNKBBW-SP	50	120-150	5845
1.5 HP	8.9 - 13.5	16 Amp	CPGNKSBW-SP(RC72)	72	120-150	5845
1.5 HP	8.9 - 13.5	16 Amp	CPGNKBBW-SP(RC72)	72	120-150	5845
2 HP	13.2 - 20	16 Amp	CPGNLBBW-SP	72	150-200	6215
2 HP	13.2 - 20	16 Amp	CPGNLBBW-SP(2RC36)	36x2	150-200	6215
2 HP	13.2 - 20	16 Amp	CPGNLBBW-SP(2R36)	36x2	150-200	6215
2 HP	13.2 - 20	16 Amp	CPGNLBBW-RC90SC150	45X2	120-150	6215
2 HP	13.2 - 20	16 Amp	CPGNLBBW-R100SC150	100	120-150	6215
3 HP	17.4 - 24	25 Amp	CPGNMNBW-SP	100	200-250	6785
3 HP	17.4 - 24	25 Amp	CPGNMNBW-SP	100	200-250	6785
3 HP	17.4 - 24	25 Amp	CPGNMNBW-SP(2RC50)	50x2	200-250	6785
3 HP	17.4 - 24	25 Amp	CPGNMNBW-SP(2R50)	50x2	200-250	6785
3 HP	22 - 30	25 Amp	CPGNMNBW-SP(2RC50)	50x2	200-250	7125

1-Phase SPS With 2P Contactor + Overload Relay + Dry Run Protection

HSN CODE : 8536



HP at 1Ø, 220V, 50Hz	Overload Relay Range (A)	Contactor Rating (AC-3)	Cat. No.	Run Capacitor (mfd)	Start Capacitor (mfd)	MRP [₹]
0.75 HP	3.8 - 6	16 Amp	CPGND1HBW-SP	25	80-100	6085
1 HP	6 - 9.3	16 Amp	CPGND1JBW-SP	36	100-120	6290
1 HP	6 - 9.3	16 Amp	CPGND1JBBW-SP	36	100-120	6290
1 HP	6 - 9.3	16 Amp	CPGND1JBW-SP(RC50)	50	100-120	6335
1 HP	6 - 9.3	16 Amp	CPGND1JBW-R50S100	50	100-120	6520
1.5 HP	8.9 - 13.5	16 Amp	CPGND1KBW-SP	50	120-150	6860
1.5 HP	8.9 - 13.5	16 Amp	CPGND1KBBW-SP	50	120-150	6860
1.5 HP	8.9 - 13.5	16 Amp	CPGND1KBW-SP(RC72)	72	120-150	7035
2 HP	13.2 - 20	16 Amp	CPGND1LBW-SP	72	150-200	7340
2 HP	13.2 - 20	16 Amp	CPGND1LBBW-SP	72	150-200	7340
2 HP	13.2 - 20	16 Amp	CPGND1LBW-SP-2R36	36x2	150-200	7525
2 HP	13.2 - 20	16 Amp	CPGND1LBBW-SP-2R36	36x2	150-200	7525
2 HP	13.2 - 20	16 Amp	CPGND1LBW-R90S150	45X2	150-200	7535
2 HP	13.2 - 20	16 Amp	CPGND1LBW-R100S150	100	150-200	7400
3 HP	17.4 - 24	25 Amp	CPGND1MBW-SP	100	200-250	8160
3 HP	17.4 - 24	25 Amp	CPGND1MNBW-SP	100	200-250	8160
3 HP	17.4 - 24	25 Amp	CPGND1MBW-SP-2R50	50x2	200-250	8475
3 HP	17.4 - 24	25 Amp	CPGND1MNBW-SP-2R50	50x2	200-250	8475
3 HP	22 - 30	25 Amp	CPGND1NBW-SP-2R50	50x2	200-250	8970

1-Phase SPS with 2P DPC Contactor + MCB

HSN CODE : 8536



HP at 1Ø, 220V, 50Hz	SP MCB "C" Curve	Contactor Rating (AC-3)	Cat. No.	Run Capacitor (mfd)	Start Capacitor (mfd)	MRP [₹]
0.5 HP	6A	20A	CPD2A05CJ06	25	80-100	3815
0.75 HP	10A	20A	CPD2A07AK10	36	40-60	3815
1 HP	10A	20A	CPD2A10BM10	50	60-80	3840
1 HP	10A	20A	CPD2A10CK10	36	80-100	3840
1 HP	10A	20A	CPD2A10DK10	36	100-120	3870
1 HP	10A	20A	CPD2A10DM10	50	100-120	3920
1.5 HP	16A	20A	CPD2A15DL16	72	100-120	3985
1.5 HP	16A	20A	CPD2A15GM16	50	120-150	3985
1.5 HP	16A	20A	CPD2A15GL16	72	120-150	4055

Spares for 1-Phase Submersible Pump Starter (CPD)



Cat. No.	Description	MRP[₹]
SPA1A30V300	Digital VA Meter A1, AM30A, VM300V, S-72	705
SPA1VM-CT	CT for Digital VA Meter A1	140
SPARC	Off Push Button Red for 1Ph CPD SPS	275
SPAGC	On Push Button Green for 1Ph CPD SPS	335
SPATB530	Terminal Block 30A 5W for 1Ph CPD SPS	165
CPDN202KL	20A, 2P DP Contactor	1055
SP402MCKL	Coil 170-240V 2P DP Contactor (Bulk Pack of 12 nos.)	2735

1-Phase SPS With 2 Pole Contactor + Overload Relay (With Ammeter)

HSN CODE : 8536



Cat. No.	HP at 1Ø, 220V, 50Hz	Overload Relay Range (A)	Contactor Rating (AC-3)	Run Capacitor (mfd)	Start Capacitor (mfd)	MRP[₹]
CPNEHBW-SP	0.5 / 0.75 HP	3.8 - 6.0	16 Amp	25	80/100	5550
CPNEJBW-SP	1 HP	6.0 - 9.3	16 Amp	36	100/120	5855
CPNEKBW-SP	1.5 HP	8.9 - 13.5	16 Amp	50	120/150	6400
CPNELBW-SP	2 HP	13.2 - 20.0	16 Amp	36+36	150/200	6820
CPNEMBW-SP	3 HP	17.4 - 24.0	25 Amp	50+50	200/250	7775
CPNEPBW-SP	5 HP	23.0 - 32.0	40 Amp	50+50+50	200/250	11705

Suffix "D" in Cat Code for Dry Run Protection panel (only Extra Terminal is provided to connect Dry Run unit)

1-Phase SPS With Mini Manual DOL Starter (With Ammeter + Voltmeter)

HSN CODE : 8536



Cat. No.	HP at 1Ø, 220V, 50Hz	Overload Relay Range (A)	Run Capacitor (mfd)	MRP[₹]
CPPM50-25-SP	0.5 / 0.75HP	3.5 - 6.5	25	4260
CPPM50H-25-SP	0.5 / 0.75HP	3.5 - 6.5	25	4850
CPPM60-25-SP	1 HP	6.8 - 11	25	4290
CPPM60-36-SP	1 HP	6.8 - 11	36	4290
CPPM60H-36-SP	1 HP	6.8 - 11	36	4880
CPPM60-50-SP	1.5 HP	6.8 - 11	50	4515
CPPM60H-50-SP	1.5 HP	6.8 - 11	50	5130
CPPM70-36-SP	2 HP	11.0 - 20.0	36	4580
CPPM70-50-SP	2 HP	11.0 - 20.0	50	4580
CPPM70H-50-SP	2 HP	11.0 - 20.0	50	5215

DOL Starter - 3 Phase

HSN CODE : 8536

Cat. No.	Overload Relay Range (A)	HRC Fuse Rating (EE Type) (max)	MRP [₹]
OISWPGT	2.4 - 3.8	16A	4635
OISWPHT	3.8 - 6.0	20A	4635
OISWPJT	6.0 - 9.3	25A	4635
OISWPKT	8.9 - 13.5	36A	4635
OISWPLT	13.2 - 20.0	50A	4725
OISWPMT	17.4 - 24.0	63A	5115

Note : The last alphabet in the Cat No. indicates coil voltage : N-380-415VAC ; T-220-400VAC ; Y-240-400VAC

Star Delta Starter - Fully Automatic

HSN CODE : 8536

Cat. No.	Overload Relay Range (A)	HRC Fuse Rating (EE Type) (max)	MRP [₹]
OISDAWPJ*	6.0 - 9.3	20A	13740
OISDAWPK*	8.9 - 13.5	32A	13740
OISDAWPL*	13.2 - 20.0	35A	13740
OISDAWPM*	17.4 - 24.0	50A	14695
OISDAWPP*	23.0 - 32.0	63A	15385
OISDAWPQ*	26.0 - 40.0	80A	15680



Star Delta Starter - Semi Automatic

HSN CODE : 8536

Cat. No.	Overload Relay Range (A)	HRC Fuse Rating (EE Type) (max)	MRP [₹]
OISDSWPJ*	6.0 - 9.3	20A	12335
OISDSWPK*	8.9 - 13.5	32A	12335
OISDSWPL*	13.2 - 20.0	35A	12335
OISDSWPM*	17.4 - 24.0	50A	13265
OISDSWPP*	23.0 - 32.0	63A	13920
OISDSWPQ*	26.0 - 40.0	80A	14210

Star Delta Starter - Fully Automatic with Auto Unit SPP & 3 Position Auto Manual Switch

HSN CODE : 8536

Cat. No.	Overload Relay Range (A)	HRC Fuse Rating (EE Type) (max)	MRP [₹]
OISDYWPJ*	6.0 - 9.3	20A	16080
OISDYWPK*	8.9 - 13.5	32A	16080
OISDYWPL*	13.2 - 20.0	35A	16080
OISDYWPM*	17.4 - 24.0	50A	17100
OISDYWPP*	23.0 - 32.0	63A	17895
OISDYWPQ*	26.0 - 40.0	80A	18180

Star Delta Starter - Fully Automatic with Ammeter & Voltmeter

HSN CODE : 8536

Cat. No.	Overload Relay Range (A)	HRC Fuse Rating (EE Type) (max)	MRP [₹]
OISDPYWPL*	13.2 - 20.0	35 A	19770
OISDPYWPM*	17.4 - 24.0	50 A	20800
OISDPYWPP*	23.0 - 32.0	63 A	21750
OISDPYW PQ*	26.0 - 40.0	80 A	22045

'N' for 380-415VAC coil & 'Y' for 240-400VAC coil

Spares for Oil Starter

HSN CODE : 8538

Description			
Contact kit without coil for DOL - Power & Auxiliary contacts (set of fix contact, moving contact, hex screws, spring washer, spring clip, spring cap, contact spring)		OCK	600
Power kit without coil for all 3 contactor of star delta starter (fix contact, moving contact, hex screw, spring washer, spring clip, spring cap, contact spring)		Upto L Relay - OCKSD20	1480
		M, P Relay OCKSD30	1715
Auxiliary Contact Kit set for Star Delta Starter		Upto L Relay - OCKSDAUX20	395
		M, P Relay OCKSDAUX30	395
Coil -Main & Delta Contactor	220-400V	OCT	725
	240-400V	OCY	725
	380-415V	OCN	725
Coil -Star Contactor	220-400V	OCT-STAR	445
	240-400V	OCY-STAR	445
	380-415V	OCN-STAR	445
ON-Push Button		OPB-ON	190
OFF-Push Button		OPB-OFF	190
Incoming Mounting KIT for 20A		OCTKSD20	205
Incoming Mounting KIT for 30A		OCTKSD30	280

'NHD' Series 2 Pole Contactor

HSN CODE : 8536



AC# Rating at 240 V AC		Cat. No.	MRP [₹]
AC-1 (A)	AC-3 (A)		
20	12	CPG212*	1720
25	16	CPG216*	1960
35	20	CPG220*	2490
40	25	CPG225*	2915
40	32	CPG232*	3565
50	40	CPG240*	4240

'NHD' Series 4 Pole Contactor

HSN CODE : 8536



Size	AC1 (A)	AC3 Rating at 415 V AC			Cat. No.	MRP [₹]
		(A)	HP	KW		
CP12	20	12	7.5	5.5	CP12N*	3270
00	20	16	10	7.5	C00N*	3640
CP20	30	20	12.5	9.3	CP20N*	4490
0	32	25	15	11	N0N*	6610
01	40	32	20	15	N01N*	9355
1	50	40	25	18.5	N1N*	11890

HSN CODE : 8538

Auxiliary Contact Blocks - NHD/CPG	1 NO	001CB10	400
Auxiliary Contact Blocks - NHD/CPG	1 NO+1NC	001CB11	475
Auxiliary Contact Blocks - NHD/CPG	2NO	001CB20	475
Auxiliary Contact Blocks - NHD/CPG	2NC	001CB02	475

'NHD' Series 1 Aux + 3 P Contactor*

HSN CODE : 8536



Size	AC1 (A)	AC3 Rating at 415 V			Cat. No.	MRP [₹]
		(A)	HP	KW		
CA12	20	12	7.5	5.5	CA12N	2835
CA16	20	16	10	7.5	CA16N	3225
CA20	30	20	12.5	9.3	CA20N	3970
NA25	32	25	15	11	NA25N	5805
NA32	40	32	20	15	NA32N	8210
NA40	50	40	25	18.5	NA40N	10515

*Auxiliary contact is at left side in 1 Aux+ 3P Contactor

Citation Series 3 Pole Contactor

HSN CODE : 8536

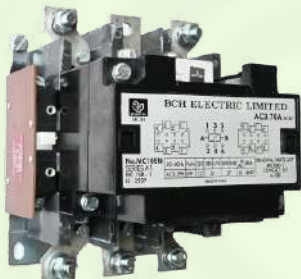

Contactor Size	AC# Rating at 415 V		Cat. No.	MRP [₹]	Cat. No.	MRP [₹]
	AC-3 (A)	HP / KW				
C4	32	20 / 15	C4NE22M	8285	C4NE11M	7745
D	40	30 / 22	MC10DN22M	13110	MC10DN11M	11535
D1	50	33.5 / 25	MC10D1N22M	15420	MC10D1N11M	14510
E	70	50 / 37	MC10EN22M	23465	MC10EN11M	22985

New

HSN CODE : 8536



Contactor Size	AC# Rating at 415 V			Aux. Contact	Cat. No.	MRP [₹]
	AC-1 (A)	AC-3 (A)	HP / KW			
M-5	150	110	80 / 60	1 NO + 1 NC	MCE15MN3M5	31965
N	300	140	100 / 75	1 NO + 1 NC	MCE15NN3M7	47665
S	315	300	220 / 160	1 NO + 1 NC	MCE15SN3M7	68890

For other Coil Voltages, kindly refer 'Coil Voltage Master Table' at page 49

Spares for Shakti Starters

HSN CODE : 8538

Cat. No.	Description	MRP [₹]
SHB	Contact Kit 20A(1Aux+3P)**	On Request
SHAA	Contact Kit 12A (1 Aux + 3P)**	1030
SHZ	Coil 190- 400 V	515
SHCC	Contact carrier	115
SHPB	Extended Button Assembly	320
SHCO	Shakti Contactor for DOL 20A	3320
SHACO	Shakti Contactor for Star Delta 16A	3565
SHCOA	Shakti Contactor for DOL 12A	2810
NCPNYAU*-5S or 5M	SPP (for ASX & OISDY)-6 Wire	1015
CPTB630	Terminal Block 30A 6-way (Auto DOL)	340
CPAMS-3P/ASX	Auto Manual Switch 3-pos (Auto DOL)	585
SHA	Contact Kit*	1255

* Shakti Kit consist of - 8 Fixed main contacts, 4 moving main contacts, 4 springs & 4 retainers

** Shakti 1 Aux + 3P Kit consist of - 6 Fixed main contacts, 3 moving main contacts, 2 Aux main contacts, 1 Aux moving contact, 4 springs & 4 retainers

HSN CODE : 8538

Cat No.	Description	MRP[₹]
SPSRW8	Power Terminal Screw - 4P NHD Contactor	135
SPSRWSD4	Screw (4nos.) for Star Delta Starter	55
SPSRWDOL2	Screw (2nos.) for DOL Starter-Citation/Shakti	40
SPGR2	Gromet (2nos.) for DOL Starter-Citation/Shakti	30

Spares for 3-Phase Submersible Pump Starter

Cat. No.	Description	MRP [₹]
NCPYAU*-5S or 5M	SPP (3 Position SPS)-6 wire	1015
BCHSPP1*-5S or 5M	SPP (6-wire)	1015
BCHSPP2*	SPP Pro (6-wire)	1015
BCHSPP2BK*	SPP Pro for BK Starters (6-Wire)	1015
SPSATWB-30S	Electronic Timer (Star Delta)	1590
CPAM25	Ammeter 25A	680
CPAM50	Ammeter 50A	680
CPAM100	Ammeter 100A	715
CPVM500	Voltmeter 500V	680
CPTB215	Terminal Block 15A 2 way	90
CPTB360	Terminal Block 60A 3 way	260
CPTB660	Terminal Block 60A 6 way	425
CPTB3100	Terminal Block 100A 3 way	870
CPMB	Mounting Bracket Set	180
CPAMS-2P	Auto Manual Switch 2 position	445
CPAMS-3P	Auto Manual Switch 3 position	475
CPVSS	Voltmeter Selector Switch	480
HEA11GM-PB	Start PB (Green)	250
HEA11RM-PB	Stop PB (Red)	250
HCB10	Aux Block (1 NO)	140
HCB01	Aux Block (1 NC)	140
CPLED-R240	Incoming LED - RED	235
CPLED-Y240	Incoming LED - YELLOW	235
CPLED-B240	Incoming LED - BLUE	235

Spares for Citation M Starters

HSN CODE : 8538

Cat. No.	Description	MRP [₹]
SP100PB3	PB assembly for Citation Starters (Manufactured Before Apr'24)	385
SP100PBC1	PB assembly for Citation Starters (Manufactured from Apr'24 onwards)	385
SP100PBC2	PB assembly for Citation SASD	385
SP100CB	Start actuator Block for DOL	340
SP100CBS	Start actuator Block for SD	340
SP100TB	Terminal Block for Star Delta Starters	330
CPTB975	Terminal Block for SD Starters (40-50 HP)	1015
CPTB9150	Terminal Block 9 way 150Amp	1800
SPSATG	Electronic Timer (Star Delta)	1590
For 250-375 HP SD Starter		
TSFB-R	Push Button (RED)	355
TSFB-G	Push Button (Green)	355
050N1	Aux Contact Block(1NO+1NC)	485

Discontinued Cat Code	SPP Type	Alternate Cat Code	SPP used in
CPAU*	2-Pos SPP	NCPAU* - 5*	2-Pos SPS
CPYAU*	3-Pos SPP	NCPYAU* - 5*	3-Pos SPS
CPNYAU*	3-Pos SPP	NCPNYAU* - 5*	Oil SD & Auto DOL

*Extra plate to be used alongwith alternate SPP

Spares for 1-Phase Submersible Pump Starter

HSN CODE : 8538

Cat. No.	Description	MRP [₹]
ILR-B	"ON" Indication Lamp	95
SPAM-10	Ammeter 10A	680
SPAM-15	Ammeter 15A	680
SPAM-25	Ammeter 25A	680
SPAM-50	Ammeter 50A	680
SPVM-300	Voltmeter 300V	680
CPTB530	Terminal Block 30A 5 way (Mini Version)	170
CPTB530H	Terminal Block 30A 5 way (Contr. Version)	280
CPTB330	Terminal Block 30A 3 way	125
CPTB240	Terminal Block 40A 2 way	180
SPGC	"ON" Push Button for 1-Ph SPS (GREEN)	325
SPRC	"OFF" Push Button for 1-Ph SPS (RED)	265
MC305TB4	Outgoing Side Terminal Block for 23-32A relay	305

Spares for Freedom DOL

HSN CODE : 8538

Cat. No.	Description	MRP [₹]
C320SCB	Start Contact Block	230
CEPBI	Push Button - Green	115
CEPBO	Push Button - Red	115

KIT for NHD

HSN CODE : 8538

Contactor Rating (AC-3)	4P KIT	MRP [₹]	1 Aux + 3P KIT	MRP [₹]	1P KIT	MRP [₹]
	Cat Code		Cat. No.		Cat. No.	
12A	SP90E1	1185	SP90E2	1075	SP90E01	320
16A	SP90A1	1465	SP90A2	1340	SP90A01	395
20A	SP90F1	1975	SP90F2	1795	SP90F01	525
25A	SP90B1	2755	SP90B2	2505	SP90B01	705
32A	SP90D1	3935	SP90D2	3575	SP90D01	1020
40A	SP90C1	4830	SP90C2	4385	SP90C01	1235

* 4P Kit consist of - 8 Fixed main contacts, 4 moving main contacts, 4 springs & 4 retainers

* 1 Aux + 3P Kit consist of - 6 Fixed main contacts, 3 moving main contacts, 2 Aux main contacts, 1 Aux moving contact, 4 springs & 4 retainers

KIT for CPG

HSN CODE : 8538

Contactor Rating	Cat. No.	MRP [₹]
12A	CPG122PSP	660
16A	CPG162PSP	765
20A	CPG202PSP	1190
25A	CPG252PSP	1900
32A	CPG322PSP	1975
40A	CPG402PSP	2970

* 2P Kit consist of - 4 Fixed contacts, 2 moving contacts, 2 springs & 2 retainers

2P Contactor

HSN CODE : 8536

2P Contactor Kit

HSN CODE : 8538

Contactor Rating	Cat. No.	MRP [₹]
16A	CPGN216*	1610
20A	CPGN220*	1815
25A	CPGN225*	2060

Rating	Cat. No.	MRP [₹]
16A	CPGN162PSP	350
20A	CPGN202PSP	380
25A	CPGN252PSP	435

* 2P Kit consist of - 4 Fixed contacts, 2 moving contacts, 2 springs & 2 retainers



Spares for P series SPS

HSN CODE : 8538

Cat. No.	Description	MRP [₹]
CPRS-ON-OFF	ROCKER SWITCH ON-OFF	95
CPTB210	10A, 2 way TB for P series SPS	85
CPLED-R	LED RED 415V	260
CPLED-A	LED AMBER 415V	260
SP100CBP	Start Actuator block for P series SPS	340
CPAM10-WH, CPAM15-WH, CPAM25-WH, CPAM50-WH	Ammeter with White Bezel (for Shakti P SPS)	680
CPVM500-WH	Voltmeter 500V White Bezel	680

Spare Coil & Carrier

Contactor	Cat. No.	MRP [₹]
Magnet Coil for NHD/ CPG	SP90MC*	530
Carrier for NHD	SP90CC	125
Carrier for CPG	CPG2PCC	80

Spares for 1-ph Dry Run SPS

HSN CODE : 8538

Cat. No.	Description	MRP [₹]
SPDRPH0.75-S1	DRY RUN PROTECTOR S1, 3.8-6.0A, 0.75 HP	1135
SPDRPJ1-S1	DRY RUN PROTECTOR S1, 6.0-9.3A, 1 HP	1135
SPDRPK1.5-S1	DRY RUN PROTECTOR S1, 8.9-13.5A, 1.5 HP	1135
SPDRPL2-S1	DRY RUN PROTECTOR S1, 13.2-20A, 2 HP	1135
SPDRPM3-S1	DRY RUN PROTECTOR S1, 17.4-24A, 3 HP	1135
SPDRPN3-S1	DRY RUN PROTECTOR S1, 22-30A, 3 HP	1135
SPDRPP5-S1	DRY RUN PROTECTOR S1, 23-32A, 5HP	1135
SPDRP-CT-S1	CT FOR DRY RUN PROTECTOR S1	135
SPDRPCONNECTOR-S1	CONNECTOR FOR DRY RUN PROTECTOR S1	75

Dual Meter

HSN CODE : 9030

Cat. No.	MRP [₹]
CPAM10VM300, CPAM15VM300, CPAM25VM300, CPAM30VM300, CPAM50VM300	930
CPAM10VM500, CPAM15VM500, CPAM30VM500, CPAM60VM500	990
CPAM30-60VM500S72	965
CPAM60-120VM500S72	1040
CPAM30-60VM500S96	1230
CPAM60-120VM500S96	1375

Spare Freedom Overload Relays for Citation P32 to Citation P100

HSN CODE : 8536

Cat. No.	Overload Relay Range (A)	MRP [₹]
MC318GNA3B	22 - 32	3455
MC318GNA3C	29 - 42	3465
MC318GNA3D	36 - 52	4685
MC318GNA3E	45 - 63	5215
MC318GNA3F	60 - 80	6415

Adaptor for Individual mounting Cat Code- C318F2 (MRP Rs. 580)

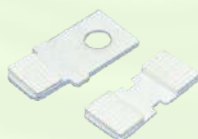

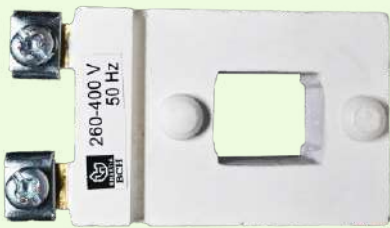

COIL VOLTAGE : MASTER TABLE

PRODUCT	160-220V	170-240V	220-240V	230-360V	260-400V	310-400V	190-400V	230-420V	275-420V	380-415V	415V	440V	550V
WORKING VOLTAGE BAND	136-242V	145-264V	187-264V	196-396V	221-440V	264-440V	162-440V	196-462V	234-462V	323-456V	353-456V	374-484V	468-605V
CPG 2P	BW	BBW	H	-	-	-	-	-	-	N	-	-	-
	BW	BBW	H	-	-	-	-	-	-	N	-	-	-
	BW	BBW	H	-	-	-	-	-	-	N	-	-	-
SHAKTI	-	-	-	-	G	-	Z	ZB	-	N	-	-	-
	-	-	-	-	G	-	-	-	-	N	-	-	-
	-	-	H	-	G	-	-	-	MB	N	-	C	D
	-	-	H	LV	G	-	-	-	MB	N	-	-	D
	-	-	H	LV	-	WB	-	-	-	N	-	C	-
	-	-	H	-	-	WB	-	-	-	N	-	C	-
	-	-	-	-	-	-	-	-	-	-	M	C	D
	-	-	-	-	-	-	-	-	-	-	M	C	D
	-	-	-	-	-	-	-	-	-	-	M	C	D
	-	-	-	-	-	-	-	-	-	-	M	C	D

Also Available:

- * For N1N DL Coil (340-460V) option is available
- * For Citation E & M-5 (70A & 110A) LA Coil (320-400V) option is available
- * SP90MCWVN 415V (-35% - +10%) for NHD Contactor
- * 60Hz Coil 440V for NHD Contactor

Enclosures

- Bhartia Enclosure 2.0
- Terminal Box 2.0
- 'BCH-SS' (Stainless Steel) Boxes
- Terminal Boxes
- Bhartia Boxes
- TCE Series Enclosure
- Techno - Modular Enclosures
- Compartmentalized Enclosure (Fixed & Draw-out)
- Control Desk
- IT Racks - 19" and ETSI Racks
- Non Metallic Enclosure

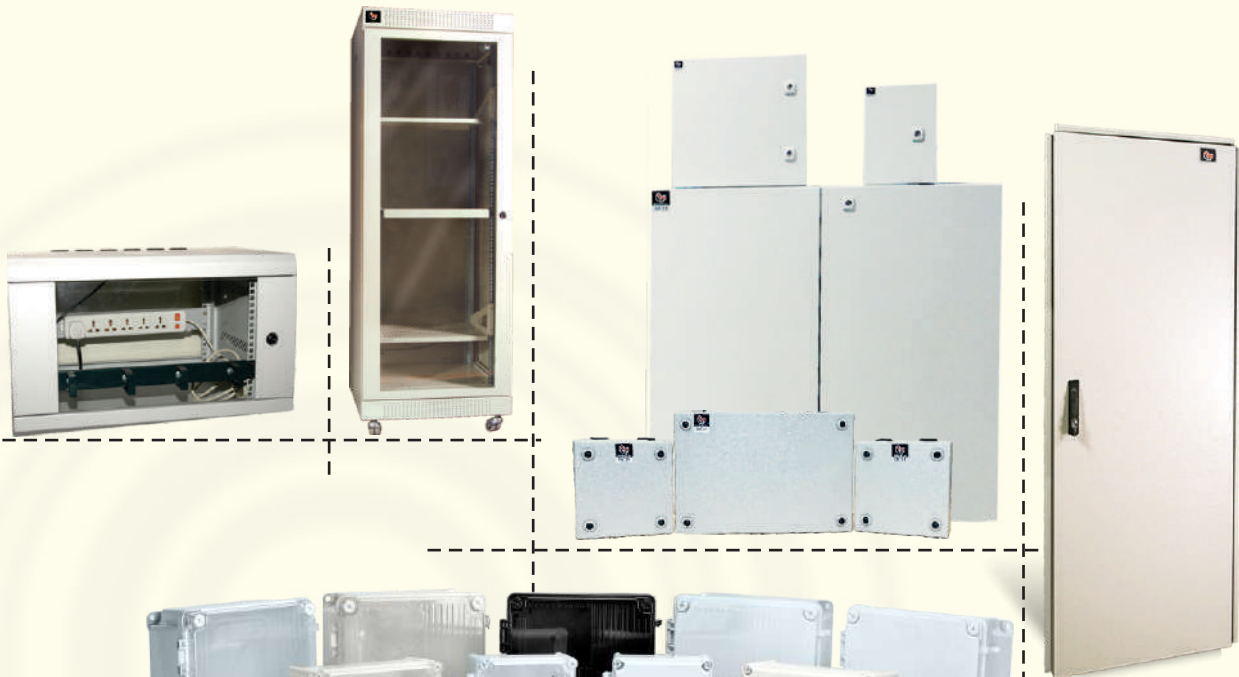
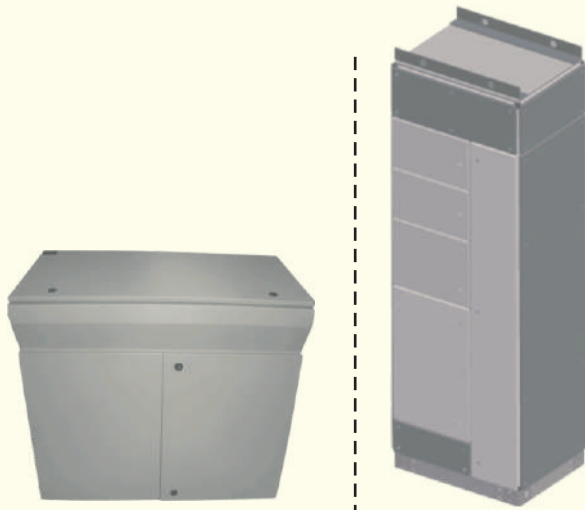



- Available in 45 different variants
- Single/Double door version
- Min. Size : 200Wx300Hx150D mm
- Max. Size : 1200Wx1400Hx400D mm
- Degree of protection
IP66 - IK10 for Single door enclosure
IP55 - IK10 for Double door enclosure
- CE Certified



Technical Particulars (Bhartia Enclosure 2.0)

- Enclosure body fabricated from 1.2mm/1.6mm
- Enclosure door fabricated from 1.2mm/1.6mm/2.0mm
- Cable entry plate 1.6mm provided at bottom
- Mounting plate made 2.0/2.5mm Galvanised steel
- Foamed in PU Gasket
- Hinged door interchangeable LHS/RHS
- Door opening angle 120°
- Die casted Cam lock provided up to 1000mm height
- 3 - point lock provide for 1200mm and above height
- Powder coated to RAL - 7035 structure finish

Note: Cutout charges will be extra

: Wall mounting bracket set is an additional accessory
(For Bhartia enclosure 2.0 and Terminal Box 2.0 it not a part of standard packing)

Bhartia Enclosure 2.0

HSN CODE: 8538

Type	SIZE (WxHxD) mm	MOQ Nos.	Cat No.	List Price [₹]
SINGLE DOOR ENCLOSURE	200X300X120	1	BIL-40000	3660
SINGLE DOOR ENCLOSURE	200X300X150	1	BIL-40010	3990
SINGLE DOOR ENCLOSURE	250X300X150	1	BIL-40020	4140
SINGLE DOOR ENCLOSURE	300X300X150	1	BIL-40030	4460
SINGLE DOOR ENCLOSURE	300X300X210	1	BIL-40040	4755
SINGLE DOOR ENCLOSURE	300X400X150	1	BIL-40050	4960
SINGLE DOOR ENCLOSURE	300X400X210	1	BIL-40060	5560
SINGLE DOOR ENCLOSURE	400X300X150	1	BIL-40070	4860
SINGLE DOOR ENCLOSURE	400X300X210	1	BIL-40080	5450
SINGLE DOOR ENCLOSURE	400X400X150	1	BIL-40090	5560
SINGLE DOOR ENCLOSURE	400X400X210	1	BIL-40100	5895
SINGLE DOOR ENCLOSURE	400X500X150	1	BIL-40110	6280
SINGLE DOOR ENCLOSURE	400X500X210	1	BIL-40120	6655
SINGLE DOOR ENCLOSURE	400X600X210	1	BIL-40140	7845
SINGLE DOOR ENCLOSURE	400X600X350	1	BIL-40150	9730
SINGLE DOOR ENCLOSURE	500X500X210	1	BIL-40160	7845
SINGLE DOOR ENCLOSURE	500X500X300	1	BIL-40170	9410
SINGLE DOOR ENCLOSURE	500X600X210	1	BIL-40180	9000
SINGLE DOOR ENCLOSURE	500X700X210	1	BIL-40190	10230
SINGLE DOOR ENCLOSURE	500X700X300	1	BIL-40200	11770
SINGLE DOOR ENCLOSURE	600X400X210	1	BIL-40210	7995
SINGLE DOOR ENCLOSURE	600X400X300	1	BIL-40220	10275
SINGLE DOOR ENCLOSURE	600X600X210	1	BIL-40230	9650
SINGLE DOOR ENCLOSURE	600X600X300	1	BIL-40240	11590
SINGLE DOOR ENCLOSURE	600X600X350	1	BIL-40250	12295
SINGLE DOOR ENCLOSURE	600X800X210	1	BIL-40260	11650
SINGLE DOOR ENCLOSURE	600X800X250	1	BIL-40270	13365
SINGLE DOOR ENCLOSURE	600X800X300	1	BIL-40280	13335
SINGLE DOOR ENCLOSURE	600X1000X210	1	BIL-40290	14690
SINGLE DOOR ENCLOSURE	600X1000X300	1	BIL-40300	16665
SINGLE DOOR ENCLOSURE	600X1200X300	1	BIL-40310	19135
SINGLE DOOR ENCLOSURE	800X600X300	1	BIL-40320	13255
SINGLE DOOR ENCLOSURE	800X800X210	1	BIL-40330	14645
SINGLE DOOR ENCLOSURE	800X800X300	1	BIL-40340	15550
SINGLE DOOR ENCLOSURE	800X1000X250	1	BIL-40350	17675
SINGLE DOOR ENCLOSURE	800X1000X300	1	BIL-40360	17885
SINGLE DOOR ENCLOSURE	800X1200X300	1	BIL-40370	22280
DOUBLE DOOR ENCLOSURE	1000X800X210	1	BIL-40380	18690
DOUBLE DOOR ENCLOSURE	1000X800X300	1	BIL-40390	21430
DOUBLE DOOR ENCLOSURE	1000X1000X300	1	BIL-40400	24925
DOUBLE DOOR ENCLOSURE	1000X1200X300	1	BIL-40410	28645
DOUBLE DOOR ENCLOSURE	1000X1400X300	1	BIL-40420	34265
DOUBLE DOOR ENCLOSURE	1000X1400X400	1	BIL-40430	38095
DOUBLE DOOR ENCLOSURE	1200X1400X300	1	BIL-40440	36125
DOUBLE DOOR ENCLOSURE	1200X1400X400	1	BIL-40450	39760

MOQ : Minimum order quantity in nos.

HSN CODE: 8538

Type	Cat No.	MOQ Nos.	List Price [₹]
Set of Wall Mounting Bracket (small)	BIL-WM-S	1	205
Set of Wall Mounting Bracket (big)	BIL-WM-B	1	235
Wall Mounting Bracket Kit 20mm	BIL-WM-H20	1	350

Note :

* Set of wall mounting bracket (small) is suitable for all range of terminal boxes 2.0 and Bhartia Enclosure 2.0 upto size : 400x500x200mm.

* Set of wall mounting bracket (big) is suitable for Bhartia Enclosure 2.0 beyond size : 400x500x200mm.

*List Prices are Ex-works Faridabad. For detail refer Enclosure Selling Terms & Conditions.

***GST to be charged extra**

www.bchindia.com

Effective from 17.11.2025



- Available in 22 different variants
- Min. Size : 150Wx150Hx80D mm
- Max. Size : 600Wx400Hx120D mm
- Degree of protection:IP66 - IK10
- CE Certified



Terminal Box 2.0

HSN CODE: 8538

SIZE (W x H x D) mm	MOQ	Cat No.	List Price [₹]
150X150X80	1	BIL-30000	1785
200X150X80	1	BIL-30010	1970
300X150X80	1	BIL-30020	2275
200X200X80	1	BIL-30030	2070
300X200X80	1	BIL-30040	2210
400X200X80	1	BIL-30050	2365
600X200X80	1	BIL-30060	3210
150X150X120	1	BIL-30070	2035
200X150X120	1	BIL-30080	2105
300X150X120	1	BIL-30090	2320
400X150X120	1	BIL-30100	2730
200X200X120	1	BIL-30110	2275
300X200X120	1	BIL-30120	2520
400X200X120	1	BIL-30130	2865
500X200X120	1	BIL-30140	3590
600X200X120	1	BIL-30150	3970
300X300X120	1	BIL-30160	3055
400X300X120	1	BIL-30170	3660
500X300X120	1	BIL-30180	3950
600X300X120	1	BIL-30190	4775
400X400X120	1	BIL-30200	4140
600X400X120	1	BIL-30210	5200

MOQ : Minimum order quantity in nos.

Technical Particulars (Terminal Box 2.0)

- Enclosure body fabricated from 1.2mm
- Enclosure door fabricated from 1.2mm
- Holes with rubber grommet at top and bottom of enclosure body provided to facilitate cable entry
- Provision of din rail fixing in horizontal position on predrilled bracket
- Door removable type with quick release fastners
- Foamed in PU Gasket
- Powder coated to RAL - 7035 structure finish

Note: Cutout charges will be extra

*List Prices are Ex-works Faridabad. For detail refer Enclosure Selling Terms & Conditions.

***GST to be charged extra**

www.bchindia.com



- Fabricated from 1.2/1.5 mm stainless steel sheet
- Mounting Plate made up of 2.0mm Galvanised steel
- Cable entry plate 2.0mm SS 304 provided at bottom
- SS grade 304
- Foamed - in PU gasket
- Box upto BIL - 90405020 is made up of 1.2 mm SS & above of 1.5 MM SS.
- Degree of protection IP66
- 120 deg door open-able concealed hinge door with cam locking arrangement.



- 43 Different Versions
- Min. Size : 150 X 150 X 80
- Max Size : 800 X 400 X 120
- Degree of protection IP55/IP66/IK10
- C E Certified

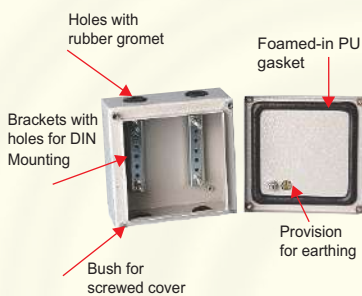

Technical Particulars (TERMINAL BOXES)

- Fabricated from 1.2mm CRCA sheet steel
- Powder coated to shade RAL 7035 Structure finish
- Foamed-in PU gasket
- Provided with screwed cover on top
- Degree of protection IP55/IP66/IK10
- C E Certified
- Brackets provided inside to facilitate DIN rail mounting
- Holes with Gromet provided to facilitate cable entry in IP 55 terminal boxes

Note: Cutout charges will be extra

'BCH - SS' (Stainless Steel)

HSN Code : 8538

Type	Size (WxHxD) mm	MOQ Nos.	Cat No.	List Price [₹]
SINGLE DOOR BOX	200X300X150	3	BIL-90203015	7765
SINGLE DOOR BOX	300X300X200	3	BIL-90303020	10755
SINGLE DOOR BOX	400X400X200	3	BIL-90404020	14230
SINGLE DOOR BOX	400X500X200	3	BIL-90405020	15850
SINGLE DOOR BOX	400X600X200	3	BIL-90406020	18165
SINGLE DOOR BOX	500X600X200	3	BIL-90506020	23265
SINGLE DOOR BOX	600X600X200	3	BIL-90606020	24880
SINGLE DOOR BOX	600X800X200	3	BIL-90608020	29575
SINGLE DOOR BOX	500X700X300	3	BIL-90507030	30040
SINGLE DOOR BOX	800X800X300	3	BIL-90808030	41360

MOQ - Minimum order quantity in nos.

Type	Cat No.	MOQ Nos.	List Price [₹]
SET OF SS WALL MOUNTING BRACKET (SMALL)	BIL-WM-S-SS	1	600
SET OF SS WALL MOUNTING BRACKET (BIG)	BIL-WM-B-SS	1	800

Terminal Boxes

HSN Code : 8538

Box Size (W x H x D)	IP-55 Range			IP-66 Range	
	MOQ	Cat. No.	List Price [₹]	Cat. No.	List Price [₹]
150x150x80	5	BIL-70000	1680	BIL-80000	1735
200x150x80	-			BIL-80100	1910
300x150x80	5	BIL-70010	1975	BIL-80010	2205
200x200x80	5	BIL-70020	1890	BIL-80020	2010
300x200x80	5	BIL-70030	2070	BIL-80030	2150
400x200x80	-			BIL-80110	2295
600x200x80	-			BIL-80130	3125
150x150x120	5	BIL-70040	1860	BIL-80040	1975
200x150x120	-			BIL-80150	2050
300x150x120	5	BIL-70050	2205	BIL-80050	2245
200x200x120	5	BIL-70060	2150	BIL-80060	2205
300x200x120	5	BIL-70070	2395	BIL-80070	2445
400x200x120	5	BIL-70080	2685	BIL-80080	2775
300x300x120	5	BIL-70090	2860	BIL-80090	2965
400x150x120	-			BIL-80170	2650
400x300x120	5	BIL-70180	3165	BIL-80180	3555
400x400x120	5	BIL-70190	3720	BIL-80190	4020
500x200x120	5	BIL-70200	3260	BIL-80200	3485
500x300x120	5	BIL-70210	3620	BIL-80210	3835
600x200x120	5	BIL-70220	3645	BIL-80220	3845
600x300x120	5	BIL-70230	4455	BIL-80230	4640
600x400x120	5	BIL-70240	4890	BIL-80240	5050
800x200x120	5	BIL-70250	5155	BIL-80250	5320
800x400x120	5	BIL-70260	6270	BIL-80260	6390

MOQ-Minimum order quantity in nos.

*List Prices are Ex-works Faridabad. For detail refer Enclosure Selling Terms & Conditions.

***GST to be charged extra**

Bhartia Boxes

HSN Code : 8538



- 51 Different Versions
- Single/Double door versions
- Min. Size : 200 X 200 X 150
- Max Size : 1200 X 1400 X 400
- Degree of protection IP55/IP66/IK10
- CE Certified

Double door version

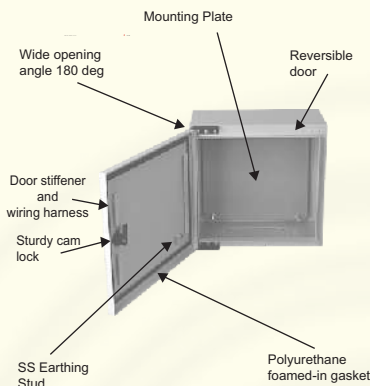

Technical Particulars (BHARTIA BOXES)

- Fabricated from 1.2mm / 1.6mm CRCA sheet steel (Sizes upto BIL-50180 made from 1.2mm CRCA, beyond this using 1.6mm CRCA)
- Foamed-in PU gasket
- Hinged door, interchangeable LHS / RHS, opening angle 180 deg for standard hinge & 120 deg for concealed hinge in bigger sizes.
- Degree of protection IP55/IP66/IK10
- CE Certified
- Cable gland plate 2mm thick provided at bottom
- Cam locking arrangement
- Powder coated to RAL : 7035 structure finish
- Mounting Plate made up of 2.0mm Galvanised steel

Note : Cutout charges will be extra

: Wall mounting bracket set is an additional accessory (for Bhartia Box & Terminal box it is not a part of standard packing)

HSN Code : 8538

Type	Cat. No.	MOQ	List Price [₹]
Set of Wall Mounting bracket (small)	BIL-WM-S	1	205
Set of Wall Mounting bracket (big)	BIL-WM-B	1	235
Set of Wall Mounting bracket Kit 20mm	BIL-WM-H20	1	350

Note :

- * Set of wall mounting bracket (small) is suitable for all range of terminal boxes and Bhartia boxes upto size : 400x500x200mm.
- * Set of wall mounting bracket (big) is suitable for Bhartia boxes beyond size : 400x500x200mm.

Type	Size (WxHxD) mm	IP-55 Range			IP-66 Range	
		Nos.	Cat. No.	List Price [₹]	Cat. No.	List Price [₹]
SINGLE DOOR BOX	200x200x150	1	BIL-50000	3380	BIL-60000	3555
SINGLE DOOR BOX	200x300x150	1	BIL-50010	3870	BIL-60010	3945
SINGLE DOOR BOX	250x300x150	1	BIL-50020	4020	BIL-60020	4145
SINGLE DOOR BOX	300x300x150	1	BIL-50030	4335	BIL-60030	4505
SINGLE DOOR BOX	300x300x200	1	BIL-50050	4620	BIL-60050	4890
SINGLE DOOR BOX	300x400x150	1	BIL-50060	4815	BIL-60060	5070
SINGLE DOOR BOX	300x400x200	1	BIL-50080	5405	BIL-60080	5435
SINGLE DOOR BOX	400x300x150	1	BIL-50090	4720	BIL-60090	5000
SINGLE DOOR BOX	400x300x200	1	BIL-50110	5290	BIL-60110	5370
SINGLE DOOR BOX	400x400x150	1	BIL-50120	5405	BIL-60120	5505
SINGLE DOOR BOX	400x400x200	1	BIL-50140	5725	BIL-60140	5900
SINGLE DOOR BOX	400x500x150	1	BIL-50150	6095	BIL-60150	6415
SINGLE DOOR BOX	400x500x200	1	BIL-50170	6460	BIL-60170	6645
SINGLE DOOR BOX	500x500x200	1	BIL-50180	7615		
SINGLE DOOR BOX	400x600x200	1	BIL-50190	7615	BIL-60190	7725
SINGLE DOOR BOX	500x600x200	1	BIL-50210	8735	BIL-60210	9000
SINGLE DOOR BOX	500x700x200	1	BIL-50220	9930		
SINGLE DOOR BOX	500x700x300	1	BIL-50230	11425		
SINGLE DOOR BOX	600x400x200	1	BIL-50240	7760	BIL-60240	8050
SINGLE DOOR BOX	600x400x300	1	BIL-50250	9975		
SINGLE DOOR BOX	600x500x200	1	BIL-50260	9000	BIL-60260	9725
SINGLE DOOR BOX	600x600x200	1	BIL-50270	9365		
SINGLE DOOR BOX	600x600x300	1	BIL-50280	11255		
SINGLE DOOR BOX	600x700x200	1	BIL-50290	11280		
SINGLE DOOR BOX	600x800x200	1	BIL-50300	11310		
SINGLE DOOR BOX	600x800x300	1	BIL-50320	12945		
SINGLE DOOR BOX	600x1000x200	1	BIL-50330	14265		
SINGLE DOOR BOX	600x1000x300	1	BIL-50340	16185		
SINGLE DOOR BOX	800x800x300	1	BIL-50310	15100		
SINGLE DOOR BOX	800x1000x200	1	BIL-50350	16810		
SINGLE DOOR BOX	800x1000x250	1	BIL-50360	17160		
SINGLE DOOR BOX	800x1000x300	1	BIL-50390	17365		
SINGLE DOOR BOX	800x1200x300	1	BIL-50395	21635		
DOUBLE DOOR BOX	1000x800x200	1	BIL-50500	18145		
DOUBLE DOOR BOX	1000x800x300	1	BIL-50520	20805		
DOUBLE DOOR BOX	1000x1000x300	1	BIL-50540	24195		
DOUBLE DOOR BOX	1000x1200x300	1	BIL-50550	27815		
DOUBLE DOOR BOX	1000x1400x300	1	BIL-50560	33265		
DOUBLE DOOR BOX	1200x1400x300	1	BIL-50570	36980		
DOUBLE DOOR BOX	1000x1400x400	1	BIL-50580	35080		
DOUBLE DOOR BOX	1200x1400x400	1	BIL-50590	38605		

MOQ. Minimum order quantity in nos.

Canopy for Bhartia Boxes

HSN Code : 8538

Size (WxHxD) mm	Cat. No.	MOQ Nos.	List Price [₹]	Size (WxHxD) mm	Cat. No.	MOQ Nos.	List Price [₹]
200WX150D	BIL-12-CAN-2015	1	890	600WX200D	BIL-16-CAN-6020	1	1705
250WX150D	BIL-12-CAN-2515	1	1010	600WX300D	BIL-16-CAN-6030	1	2090
300WX150D	BIL-12-CAN-3015	1	1080	800WX300D	BIL-16-CAN-8030	1	2545
300WX200D	BIL-12-CAN-3020	1	1175	800WX200D	BIL-16-CAN-8020	1	2070
400WX150D	BIL-12-CAN-4015	1	1225	800WX250D	BIL-16-CAN-8025	1	2230
400WX200D	BIL-12-CAN-4020	1	1350	1000WX200D	BIL-16-CAN-1020	1	2425
500WX200D	BIL-12-CAN-5020	1	1530	1000WX300D	BIL-16-CAN-1030	1	2985
500WX300D	BIL-12-CAN-5030	1	1875				

*List Prices are Ex-works Faridabad. For detail refer Enclosure Selling Terms & Conditions.

*GST to be charged extra

www.bchindia.com

TCE Series Enclosure Code Selection |

Example:-

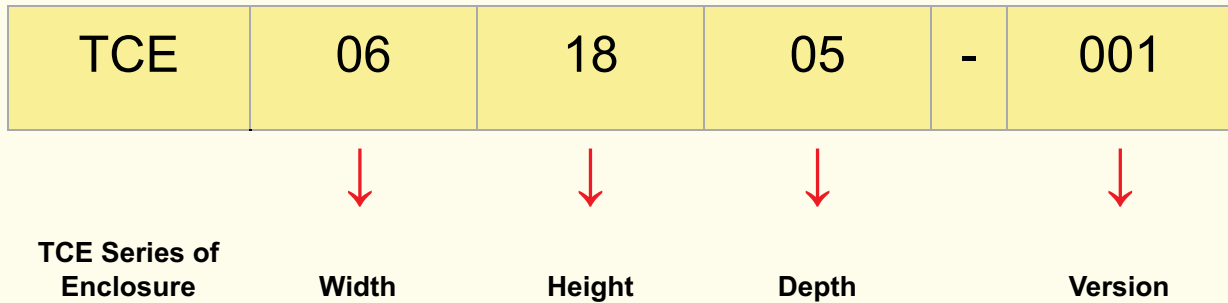

Sizes Available |

Width	Height	Depth
06-600 W	18-1800 H	04-400 D
08-800 W	20-2000 H	05-500 D
10-1000 W	22-2200 H	06-600 D
12-1200 W		08-800 D

Version Details |

001	002	003	004	005
Structure:	Structure:	Structure:	Structure:	Structure:
Front Door with Hinge	Front Door with Hinge	Front Door with Hinge	Front Door with Hinge	Front Door with Hinge
Rear Bolted Cover	Rear Door with Hinge	Rear Bolted Cover	Rear Door with Hinge	Rear Door with Hinge
STD Gland Plate	STD Gland Plate	STD Gland Plate	STD Gland Plate	STD Gland Plate
Top Cover	Top Cover	Top Cover	Top Cover	Top Cover
Eye Bolt	Eye Bolt	Eye Bolt	Eye Bolt	Eye Bolt
01 Mounting Plate	01 Mounting Plate	No Mounting Plate	No Mounting Plate	2 Mounting Plate

*List Prices are Ex-works Faridabad. For detail refer Enclosure Selling Terms & Conditions.

***GST to be charged extra**

www.bchindia.com

Technical Particulars for TCE Series

- IP66-IK10 for single door enclosure
- IP65-IK10 for double door enclosure
- Structure made up with 2.0mm CRCA
- Door made up with 2.0mm CRCA and covers made up with 1.6mm CRCA
- Bottom 3-part cable entry provision as standard and made up with 2.0mm GPSP
- Mounting plate with sliding arrangement and made up with 3.0mm GPSP
- Push fit Die casted hinge provided at doors.
- Door with Interchangeability features (LHS/RHS)
- 4-point locking provides as standards
- Separate locking at LHS door with swing handle
- Door stiffener with provision of drilling holes for wiring harness.
- Eye bolt as standard for lifting
- Modular Plinth (optional) 100mm Height with Black finish
- Side Covers – Pair consisting of 1no. LHS and 1no. RHS cover
- Surface finish to enclosure RAL-7035



Note: up to 800 mm width single door
1000 mm & 1200 mm width double door

IK10

IP66 | IP65

CE



*List Prices are Ex-works Faridabad. For detail refer Enclosure Selling Terms & Conditions.

***GST to be charged extra**

HSN Code: 8538

Size of Enclosure in mm			Cat No.	Enclosure Version*				
Width (W)	Height (H)	Depth (D)		VER-001 LP [₹]	VER-002 LP [₹]	VER-003 LP [₹]	VER-004 LP [₹]	VER-005 LP [₹]
600	1800	400	TCE061804	35075	39070	27855	32165	
800	1800	400	TCE081804	41895	45975	31850	36825	
1000	1800	400	TCE101804	57665	62145	44725	48910	
1200	1800	400	TCE121804	64805	72380	50270	55725	
600	1800	500	TCE061805	36645	40335	29730	33410	
800	1800	500	TCE081805	42665	48035	34100	38190	
1000	1800	500	TCE101805	59220	63730	46655	51440	
1200	1800	500	TCE121805	66035	75025	52895	59430	
800	1800	600	TCE081806	45490	47730	37020	40530	55460
800	1800	800	TCE081808	47470	52225	39485	44225	63355
600	2000	400	TCE062004	37800	42500	29030	34485	
800	2000	400	TCE082004	44005	48315	33620	38170	
1000	2000	400	TCE102004	63010	66540	49000	52405	
1200	2000	400	TCE122004	67690	74815	54165	61395	
600	2000	500	TCE062005	40120	43450	32935	37220	
800	2000	500	TCE082005	45015	49685	34685	39545	
1000	2000	500	TCE102005	62345	69760	49685	55130	
1200	2000	500	TCE122005	68170	75025	53590	59430	
600	2000	600	TCE062006	40715	44725	34875	38880	53815
800	2000	600	TCE082006	46570	50745	37395	41585	60230
1000	2000	600	TCE102006	63335	72665	50445	58815	88110
1200	2000	600	TCE122006	69515	77070	56300	63515	93570
600	2000	800	TCE062008	41895	45015	34990	39360	58630
800	2000	800	TCE082008	48510	52105	39645	43415	63450
1000	2000	800	TCE102008	69515	74125	53590	59430	86575
1200	2000	800	TCE122008	73075	81055	60030	66035	96700
600	2200	600	TCE062206	45890	50270	36430	43245	60230
800	2200	600	TCE082206	51930	55335	41805	46085	64580
1000	2200	600	TCE102206	71900	77440	59080	64620	90510
1200	2200	600	TCE122206	74710	83400	58065	64875	103730
600	2200	800	TCE062208	50035	54275	38390	44320	57760
800	2200	800	TCE082208	60395	63915	46370	50445	69875
1000	2200	800	TCE102208	76570	82500	62145	66840	96140
1200	2200	800	TCE122208	82815	87485	67815	72380	108425

*List Prices are Ex-works Faridabad. For detail refer Enclosure Selling Terms & Conditions.

***GST to be charged extra**

TCE Bottom Plinth 100mm Height

HSN Code: 8538

Size in MM		Cat No	LP [₹]
Width (W)	Depth (D)		
600	400	TCEPL0604	3160
800	400	TCEPL0804	3605
1000	400	TCEPL1004	4035
1200	400	TCEPL1204	4420
600	500	TCEPL0605	3380
800	500	TCEPL0805	3795
1000	500	TCEPL1005	4235
1200	500	TCEPL1205	4615
600	600	TCEPL0606	3575
800	600	TCEPL0806	3975
1000	600	TCEPL1006	4385
1200	600	TCEPL1206	4785
600	800	TCEPL0608	3975
800	800	TCEPL0808	4385
1000	800	TCEPL1008	4745
1200	800	TCEPL1208	5210



TCE Side Panel

HSN Code: 8538

Size in MM		Cat No	LP [₹]
Height (H)	Depth (D)		
1800	400	TCESP0418	6300
1800	500	TCESP0518	7315
1800	600	TCESP0618	8140
1800	800	TCESP0818	10850
2000	400	TCESP0420	6765
2000	500	TCESP0520	7960
2000	600	TCESP0620	8840
2000	800	TCESP0820	11380
2200	600	TCESP0622	10240
2200	800	TCESP0822	13310

MOQ-Minimum order quantity in nos.

Note: Cutout charges will be extra

Freight charges will be extra at actuals

*List Prices are Ex-works Faridabad. For detail refer Enclosure Selling Terms & Conditions.

***GST to be charged extra**

www.bchindia.com

TCE Series Enclosure Accessories

Baying system

HSN Code: 8538

Sl. No	Description	Cat No	LP [₹]
1	Baying Kit	TCE-14280	2340
2	Combination Angle (Pack of 2)	TCE-14281	1230

Mounting plate filler profile

HSN Code: 8538

Sl. No	Description	Cat No	LP [₹]
1	Filler plate for 1800mm Height	TCE-FP-1800	1780
2	Filler plate for 2000mm Height	TCE-FP-2000	1960
3	Filler plate for 2200mm Height	TCE-FP-2200	2150

Wiring plan pocket

HSN Code: 8538

Sl. No	Description	Cat No	LP [₹]
1	File pocket 500mm Width	TCE-TPKT-500	870
2	File pocket 600mm Width	TCE-TPKT-600	1040
3	File pocket 800mm Width	TCE-TPKT-800	1350

Lamp rail

HSN Code: 8538

Sl. No	Description	Cat No	LP [₹]
1	Lamp rail 600mm Width	TCE-LAMP-RAIL-600	250
2	Lamp rail 800mm Width	TCE-LAMP-RAIL-800	340
3	Lamp rail 1000mm Width	TCE-LAMP-RAIL-1000	420
4	Lamp rail 1200mm Width	TCE-LAMP-RAIL-1200	510

Limit switch with fixing arrangement

HSN Code: 8538

Sl. No	Description	Cat No	LP [₹]
1	BCH Limit switch	TCE-LC	1040

Punched section for depth

HSN Code: 8538

Sl. No	Description	Cat No	LP [₹]
1	Punched section 400mm depth	TCE-PSD-400	615
2	Punched section 500mm depth	TCE-PSD-500	870
3	Punched section 600mm depth	TCE-PSD-600	1110
4	Punched section 800mm depth	TCE-PSD-800	1480

Punched section for width

HSN Code: 8538

Sl. No	Description	Cat No	LP [₹]
1	Punched section 600mm width	TCE-PSW-600	1230
2	Punched section 800mm width	TCE-PSW-800	1480
3	Punched section 1000mm width	TCE-PSW-1000	1725
4	Punched section 1200mm width	TCE-PSW-1200	1960

Air Filter Unit

HSN Code: 8538

Sl. No	Description	Cat No	LP [₹]
1	Snap fit air filter 148x148	BIL-SF-1414	965
2	Snap fit air filter 204x204	BIL-SF-2020	1450
3	Snap fit air filter 255x255	BIL-SF-2525	1605
4	Snap fit air filter 204x204 with mounting adaptor	BIL-SFMA-2020	1690
5	Snap fit air filter 255x255 with mounting adaptor	BIL-SFMA-2525	2120

Door Stay

HSN Code: 8538

Sl. No	Description	Cat No	LP [₹]
1	Door Stay for TCE Series	TCE-DS	1340

Techno Modular Enclosures

HSN Code : 8538

Size of Enclosure (W x H x D in mm)	Cat. No.	Enclosure Version*				Plinth		Side Covers (Pair)	
		Ver 001 LP [₹]	Ver 002 LP [₹]	Ver 003 LP [₹]	Ver 004 LP [₹]	Cat. No.	List Price [₹]	Cat. No.	List Price [₹]
600 x 1800 x 400	TME 061804	32740	36465	26000	30015	TPL 061804	3180	TSC 061804	6345
800 x 1800 x 400	TME 081804	39110	42915	29735	34370	TPL 081804	3620	TSC 081804	6345
1000 x 1800 x 400	TME 101804	53825	58010	41740	45660	TPL 101804	4060	TSC 101804	6345
1200 x 1800 x 400	TME 121804	60470	67555	46925	52010	TPL 121804	4455	TSC 121804	6345
600 x 1800 x 500	TME 061805	34195	37650	27745	31185	TPL 061805	3405	TSC 061805	7370
800 x 1800 x 500	TME 081805	39820	44835	31835	35645	TPL 081805	3835	TSC 081805	7370
1000 x 1800 x 500	TME 101805	55290	59470	43560	48025	TPL 101805	4270	TSC 101805	7370
1200 x 1800 x 500	TME 121805	61640	70030	49370	55475	TPL 121805	4645	TSC 121805	7370
800 x 1800 x 600	TME 081806	42455	44570	34565	37825	TPL 081806	4005	TSC 081806	8195
600 x 2000 x 400	TME 062004	35290	39650	27100	32205	TPL 062004	3180	TSC 062004	6825
800 x 2000 x 400	TME 082004	41065	45105	31380	35625	TPL 082004	3620	TSC 082004	6825
1000 x 2000 x 400	TME 102004	58825	62100	45740	48910	TPL 102004	4060	TSC 102004	6825
1200 x 2000 x 400	TME 122004	63195	69840	50560	57295	TPL 122004	4455	TSC 122004	6825
600 x 2000 x 500	TME 062005	37460	40555	30735	34740	TPL 062005	3405	TSC 062005	8010
800 x 2000 x 500	TME 082005	42020	46385	32380	36925	TPL 082005	3835	TSC 082005	8010
1000 x 2000 x 500	TME 102005	58195	65115	46385	51465	TPL 102005	4270	TSC 102005	8010
1200 x 2000 x 500	TME 122005	63635	70030	50010	55475	TPL 122005	4645	TSC 122005	8010
600 x 2000 x 600	TME 062006	38000	41740	32555	36295	TPL 062006	3590	TSC 062006	8915
800 x 2000 x 600	TME 082006	43470	47375	34910	38825	TPL 082006	4005	TSC 082006	8915
1000 x 2000 x 600	TME 102006	59110	67825	47100	54910	TPL 102006	4430	TSC 102006	8915
1200 x 2000 x 600	TME 122006	64885	71930	52540	59285	TPL 122006	4840	TSC 122006	8915
600 x 2000 x 800	TME 062008	39110	42020	32650	36725	TPL 062008	4005	TSC 062008	11460
800 x 2000 x 800	TME 082008	45280	48650	37005	40525	TPL 082008	4430	TSC 082008	11460
1000 x 2000 x 800	TME 102008	64885	69200	50010	55475	TPL 102008	4775	TSC 102008	11460
1200 x 2000 x 800	TME 122008	68210	75640	56030	61640	TPL 122008	5265	TSC 122008	11460
600 x 2200 x 600	TME 062206	42830	46925	34020	40365	TPL 062206	3590	TSC 062206	10325
800 x 2200 x 600	TME 082206	48475	51655	39005	43010	TPL 082206	4005	TSC 082206	10325
1000 x 2200 x 600	TME 102206	67110	72280	55140	60320	TPL 102206	4430	TSC 102206	10325
1200 x 2200 x 600	TME 122206	69735	77840	54205	60560	TPL 122206	4840	TSC 122206	10325
600 x 2200 x 800	TME 062208	46710	50665	35835	41380	TPL 062208	4005	TSC 062208	13410
800 x 2200 x 800	TME 082208	56375	59660	43305	47100	TPL 082208	4430	TSC 082208	13410
1000 x 2200 x 800	TME 102208	71460	77000	58010	62385	TPL 102208	4775	TSC 102208	13410
1200 x 2200 x 800	TME 122208	77295	81645	63290	67555	TPL 122208	5265	TSC 122208	13410

*Baying kit (BIL-14280) Rs. 2150/- is also available for Enclosure Version. For extra accessories, please contact nearest branch office.

MOQ-Minimum order quantity in nos.

Note : Cutout charges will be extra

Freight charges will be extra at actuals

*List Prices are Ex-works Faridabad. For detail refer Enclosure Selling Terms & Conditions.

***GST to be charged extra**

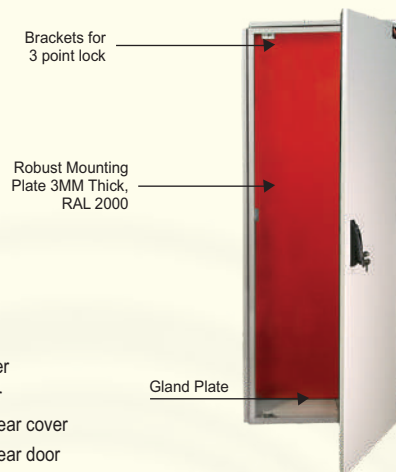

Modular Enclosures

- Enclosures
- Minimum size in mm :
600 x 1800 x 400 (W x H x D)
- Maximum size in mm :
1200 x 2200 x 800 (W x H x D)
- Degree of protection IP55/IK10
- CE Certified
- Wide range of accessories

Features

- Completely modular in all the three axis
- Powder coated surface (RAL 7035) for excellent finish and durability
- PU Gasket ensuring higher degree of ingress protection
- 3mm mounting plate as a standard
- Manufactured on CNC Turret punch press for higher precision, finish and repeated accuracy
- Ideal for :
 - Special purpose machines
 - Control panels
 - Drives
 - Starter enclosures
 - Accessories for mounting 19" equipment

Enclosure Versions

- 001 - with mounting plate and rear cover
- 002 - with mounting plate and rear door
- 003 - without mounting plate and with rear cover
- 004 - without mounting plate and with rear door

To Order And Calculate List Price

- (a) Choose Cat. No. and LP of Enclosure version from 001, 002, 003 or 004
- (b) Add Cat. No. and LP of Plinth
- (c) Add Cat. No. and LP of Side Covers pair

General Technical Particulars

- Degree of protection IP55/IK10
- CE Certified
- Fabricated from 2/1.6 mm CRCA/GPSP (frame made up of 2.0mm GPSP, doors & covers made up of 1.6 mm CRCA).
- Fully bolted construction
- Mounting Plate with sliding arrangement - standard & Powder coated to RAL-2000
- Modular Plinth (optional) 100mm high fabricated from CRCA
- Cable entry provision is given from Bottom & made in 3-part construction with Galvanized steel [Unpainted]
- Foamed-in PU gasket
- Powder coated to RAL : 7035 structure finish
- Hinge design allows 120 deg. Door opening
- 3 point lock provided as standard
- Door stiffener with provision of drilling holes for wiring harness.
- Side Covers - Pair : consisting of 1no. LHS and 1no. RHS cover
- To calculate limiting dimension of the enclosure, add 44mm to the width to account for Side Covers,
- 22mm to the height for Top Cover & 44mm to the depth on account of Front and Rear door / cover.

Note : upto 800 mm width single door
1000 mm & 1200 mm width double leaf door

*List Prices are Ex-works Faridabad. For detail refer Enclosure Selling Terms & Conditions.

***GST to be charged extra**

www.bchindia.com

Highlights of **BCH** Compartmentalized **MCC / PCC / PMCC** Solution (Fixed & Drawed Type)



- 100% Modular Structure; can be dispatched in flat pack.
- Flexible compartmentalized - up to 4.
- IP 54 degree of protection with polyurethane foam gasket.
- Compartment size available from 200mm height & multiplies of 100mm.
- Additional accessories like Cable support, Busbar support, Limit Switch and Lamp brackets are available.
- Adjustable mounting plates (Depth wise at the pitch of 25mm).
- Panel can be expanded in all 3 dimensions and bayed together by using Baying Kit.
- All Structure members (Corner & Cross bar) having M6 extrude hole at 25mm intervals, No need of any Captive hardware.
- Standard Module dimension for Drawout Enclosures.
 - ▷ Single Front :- 900(W) x 2400(H) x 600(D)
 - ▷ Double Front :- 900(W) x 2400(H) x 1200(D)
- Draw-out feeder available from 200mm height (2SU) to 800mm height (8SU).
- Colours :- RAL-7035 (Structure finish) for structure, doors, covers & internal parts RAL-2000 (smooth finish) for Mounting plates, RaI-9000 (Smooth Finish) for Plinth.
- Sheet thickness 2.0mm GPSP for structure, 2.0mm CRCA for Mounting Plate & Mounting rail, 1.6mm CRCA for Doors & Covers, 1.2mm CRCA for Separation plates.

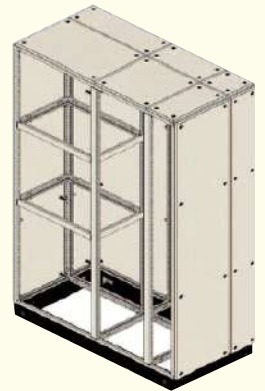
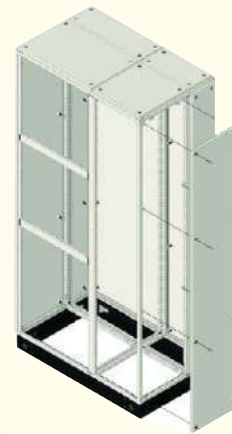

Technical Particulars (CONTROL DESK):

- Desk body: 1.6mm CRCA sheet
- Hinged door: 1.6mm CRCA sheet
- Bottom Gland plate: 2.0mm CRCA sheet
- Mounting plate: 2.0mm GPSP sheet
- Plinth corner: 2.0mm CRCA sheet
- Plinth Trim Plates: 1.6mm CRCA sheet
- Foamed-in PU gasket at front door
- Powder coated to RAL: 7035 structure finish
- Bottom plinth painted with smooth black color
- Mounting plate Zn galvanized



Control Desk

HSN Code : 8538

Type	SIZE (WxHxD) mm	Control DESK		
		MOQ Nos.	Cat No.	List Price [₹]
SINGLE DOOR CONTROL DESK	600X1000X400	3	BIL-CD-061004	19750
SINGLE DOOR CONTROL DESK	800X1000X400	3	BIL-CD-081004	23500
SINGLE DOOR CONTROL DESK	600X1000X500	3	BIL-CD-061005	21500
SINGLE DOOR CONTROL DESK	800X1000X500	3	BIL-CD-081005	26000
DOUBLE DOOR CONTROL DESK	1000X1000X400	3	BIL-CD-101004	27500
DOUBLE DOOR CONTROL DESK	1200X1000X400	3	BIL-CD-121004	32000
DOUBLE DOOR CONTROL DESK	1000X1000X500	3	BIL-CD-101005	31400
DOUBLE DOOR CONTROL DESK	1200X1000X500	3	BIL-CD-121005	35500

Bottom Plinth for Control Desk

HSN Code : 8538

Size in MM		MOQ Nos.	Cat No	List Price [₹]
Width (W)	Depth (D)			
600	400	3	BIL-CDPL-0604	3250
800	400	3	BIL-CDPL-0804	3700
1000	400	3	BIL-CDPL-1004	4150
1200	400	3	BIL-CDPL-1204	4550
600	500	3	BIL-CDPL-0605	3500
800	500	3	BIL-CDPL-0805	3950
1000	500	3	BIL-CDPL-1005	4400
1200	500	3	BIL-CDPL-1205	4800



Key Attributes:

- Aesthetic & robust construction
- Mounting Fan /s in top doesn't take usable "U" space.
- Special type of Wallmounting hardware.
- Provision for earthing available in the cabinets.
- Highly corrosion resistant in nature.
- Power coated to shade RAL : 7035 structure finish.



Key Attributes:

- Floor mounting robust design.
- Lockable & removable side panels.
- 2-pairs of adjustable 19" rails.
- Front door with toughened glass & perforation.
- High load bearing capacity.
- Rear vented door.
- Provision for fan mounting in top which doesn't take usable "U" Space.
- Superior cable management facility in extra wide racks.
- 4-integrated vertical cable managers are default design of 800mm wide racks.
- Rear space saving split door with 3-point secure locking in extra wide (800mm) racks.
- Power coated to shade RAL : 7035 structure finish.

19" Wall Mount Racks

HSN Code : 8538

Dimensions (H x W x D) mm	MOQ Nos.	Cat. No.	List Price [₹]
6UX550X400	1	BIL-W-6-5504	6065
9UX550X400	1	BIL-W-9-5504	7315
6UX550X500	1	BIL-W-6-5505	6695
9UX550X500	1	BIL-W-9-5505	7805
12UX550X500	1	BIL-W-12-5505	8670
15UX550X500	1	BIL-W-15-5505	10205

MOQ-Minimum order quantity in nos.

Standard Configuration: Wallmount cabinet, 2-Pairs of 19" rail.

Notes: Accessories viz. Shelves, Fans, power strips, cable managers captive H/W & wall mounting hardware etc. will be extra as per the accessories list furnished in the price list.
Wall mount racks price do not include freight & will be extra at actuals

19" Networking Racks

HSN Code : 8538

Dimensions (H x W x D) mm	MOQ Nos.	Cat. No.	List Price [₹]
24U X 600 X 600	1	BIL-N-062406	33915
24U X 600 X 800	1	BIL-N-062408	37495
24U X 800 X 600	1	BIL-N-082406	42500
24U X 800 X 800	1	BIL-N-082408	46445
30U X 600 X 600	1	BIL-N-063006	37495
30U X 600 X 800	1	BIL-N-063008	41085
30U X 800 X 600	1	BIL-N-083006	46445
30U X 800 X 800	1	BIL-N-083008	50910
36U X 600 X 600	1	BIL-N-063606	41085
36U X 600 X 800	1	BIL-N-063608	45540
36U X 800 X 600	1	BIL-N-083606	50930
36U X 800 X 800	1	BIL-N-083608	55295
42U X 600 X 600	1	BIL-N-064206	47345
42U X 600 X 800	1	BIL-N-064208	50730
42U X 800 X 600	1	BIL-N-084206	55725
42U X 800 X 800	1	BIL-N-084208	61605
45U X 600 X 600	1	BIL-N-064506	54475
45U X 600 X 800	1	BIL-N-064508	57175
45U X 800 X 600	1	BIL-N-084506	59825
45U X 800 X 800	1	BIL-N-084508	65185

MOQ-Minimum order quantity in nos.

Notes : 1) Networking racks price do not include freight & this will be extra at actuals.

For more details visit : www.bchindia.com/technorack

*List Prices are Ex-works Faridabad. For detail refer Enclosure Selling Terms & Conditions.

***GST to be charged extra**

19" Server Racks

HSN Code : 8538

Key Attributes:

- Floor mounting robust design.
- Lockable & removable side panels.
- 2-pairs of adjustable 19" rails.
- Front door with toughened glass & perforation.
- High load bearing capacity.
- Rear vented door.
- Provision for fan mounting in top which doesn't take usable "U" Space.
- Superior cable management facility in extra wide racks.
- 4-integrated vertical cable managers are default design of 800mm wide racks.
- Rear space saving split door with 3-point secure locking
- locking in extra wide (800mm) racks.
- Power coated to shade RAL : 7035 structure finish.

Dimensions (H x W x D) mm	MOQ Nos.	Cat. No.	List Price [₹]
24U X 600 X 900	1	BIL-S-062409	38315
24U X 600 X 1000	1	BIL-S-062410	40715
30U X 600 X 900	1	BIL-S-063009	43325
30U X 600 X 1000	1	BIL-S-063010	45015
36U X 600 X 900	1	BIL-S-063609	47500
36U X 600 X 1000	1	BIL-S-063610	50035
42U X 600 X 900	1	BIL-S-064209	53410
42U X 600 X 1000	1	BIL-S-064210	56800
42U X 800 X 1000	1	BIL-S-084210	65365
45U X 600 X 900	1	BIL-S-064509	61720
45U X 600 X 1000	1	BIL-S-064510	65300

MOQ - Minimum order quantity in nos.

Notes : Server racks price do not include freight & this will be extra at actuals.

STANDARD CONFIGURATION: Basic frame, Top & bottom, Front Glass door with perforation, Rear vented door, Lockable & detachable side panels, 2-Pairs of 19" rails with depth members.



Key Attributes:

- Includes 1-Pair of 21" rails.
- Integrated side panels.
- Grouting arrangements along with grouting bolts as std. BOM
- Provision for power & detachable Cable entry/exit in top & bottom.
- Power coated to shade RAL : 7035 structure finish.

ETSI Racks

HSN Code : 8538

Dimensions (H x W x D) mm	MOQ Nos.	Cat. No.	List Price [₹]
2200 X 600 x 300	1	ITE-062203	On request
2200 X 600 x 600	1	ITE-062206	On request

MOQ - Minimum order quantity in nos.

Notes : Above ETSI configuration do not include front & rear door and covers.

All other accessories will be extra & will be furnished on request.

The prices mentioned above do not include freight.



Key Attributes:

- 1-Pair of vertical cable manager is default design.
- Surface pretreated and advance powder coated
- Grouting bolts as std. BOM.
- Power coated to shade RAL : 7035 structure finish.

19" Open Racks

HSN Code : 8538

Dimensions (H x W) mm	MOQ Nos.	Cat. No.	List Price [₹]
36U X 600	1	ITE-OF-0636	On request
45U X 600	1	ITE-OF-0645	On request

MOQ - Minimum order quantity in nos.

Notes : 1) Above Open Rack configuration does not include Shelves, Doors and Covers. All other accessories prices will be extra and will be furnished on request.

2) The Prices above do not include Freight and this will be extra at actuals.

For more details, visit : www.bchindia.com/technorack

*List Prices are Ex-works Faridabad. For detail refer Enclosure Selling Terms & Conditions.

***GST to be charged extra**

Accessories for 19" Racks

Fixed Shelf/Stationary Shelf

- Compatible to keep monitor, servers, non 19" Networking & allied equipments.

Key-Board Tray

- Sliding & rotatory type.

Canteliver Shelf

- It can accomodate light weighted networking & allied equipments like modem, routers etc.

Equipment Support Angle

- "L" type angles. Useful to keep non 19" heavy duty equipment in rack mounting position.

Sliding Shelf

- Useful to keep servers, networking & allied equipment which are required to slide out for operational & other purpose.

Fans/Fan Tray

- 220V 90 CFM Capacity. Can be mounted at the top either directly or through Fan housing unit (Fan Tray)

6-Point 5A Hor. Power Strip

- All universal type socket along with on/off switch with fuse & indicator. Internal strips are made up of Berellium copper that has high rate of heat & mechanical tolerance.
- Other 5A or 5/15A Power strips have Indian style (Anchor) Sockets with on/off switch/MCB.

Castors

- 1-Set includes 4Nos. of castors, 2Nos. with foot operated brake & remaining 2 are free.

Levelling Feet

- 1-Set includes 4Nos. of Levelling Feet.

Stability Plate

- It Prevents the racks from toppling while taking out heavy duty servers.

Shelves

HSN Code : 8538

Description	Cat No.	List Price [₹]
Fixed Shelf (600mmD)	BIL-A-FS-L-06	1545
Fixed Shelf (800mmD)	BIL-A-FS-L-08	2390
Fixed Shelf (900mmD)	BIL-A-FS-L-09	2655
Fixed Shelf (1000mmD)	BIL-A-FS-L-10	2860
Key board tray (Sliding & Rotatory)	BIL-A-KB-06	4565
Canteliver Shelf (1U)	BIL-A-CS-1	925
Canteliver Shelf (2U)	BIL-A-CS-2	1370
Equipment Support Angle (600mmD)	BIL-A-ESA-06	580
Equipment Support Angle (800mmD)	BIL-A-ESA-08	655
Equipment Support Angle (900mmD)	BIL-A-ESA-09	810
Equipment Support Angle (1000mmD)	BIL-A-ESA-10	940
Sliding Shelf (900mmD)	BIL-A-SS-09	4565
Sliding Shelf (1000mmD)	BIL-A-SS-10	4740

Thermal Management

HSN Code : 8538

Description	Cat No.	List Price [₹]
1-Fan (Direct mounted)	BIL-A-SF	1545
Fan-tray with 2-Fans (FHU)	BIL-A-FHU-2FANS	3300
Fan-tray with 4-Fans (FHU)	BIL-A-FHU-4FANS	5745

Cable Management

HSN Code : 8538

Description	Cat No.	List Price [₹]
Horizontal Cable Manager (1U)	BIL-A-HCM-1U	370
Horizontal Cable Manager (2U)	BIL-A-HCM-2U	455
Vertical Cable Manager (24U)	BIL-A-VCM-24U	580
Vertical Cable Manager (30U)	BIL-A-VCM-30U	735
Vertical Cable Manager (36U)	BIL-A-VCM-36U	835
Vertical Cable Manager (42U)	BIL-A-VCM-42U	925
Vertical Cable Manager (45U)	BIL-A-VCM-45U	1010

Power Management

HSN Code : 8538

Description	Cat No.	List Price [₹]
6-Point 5Amp Horizontal Power Strip (19")	BIL-A-HPS-5AMP	1510
5-Point 5/15Amp Horizontal Power Strip (19")	BIL-A-HPS-15AMP	2010
12-Point 5Amp Vertical Power Strip	BIL-A-12VPS-5AMP	2940
10-Point 5/15Amp Vertical Power Strip	BIL-A-10VPS-15AMP	3375
Earth continuity Kit (Earthing Kit)	BIL-A-ECT	1145

Stability Management

HSN Code : 8538

Description	Cat No.	List Price [₹]
Castors (1-Set) Heavy Duty	BIL-A-CAS-HD	5510
Castors (1-Set) Light Duty	BIL-A-CAS	4385
Levelling Feet (1-Set)	BIL-A-LF	750

Miscellaneous

HSN Code : 8538

Description	Cat No.	List Price [₹]
BAYING KIT	BIL-A-BK	545
BLANKING PANEL (1U)	BIL-A-BP-1U	255
BLANKING PANEL (2U)	BIL-A-BP-2U	340
BLANKING PANEL (3U)	BIL-A-BP-3U	425
BLANKING PANEL (4U)	BIL-A-BP-4U	525
BLANKING PANEL (5U)	BIL-A-BP-5U	590
Captive H/w (set of 10)	BIL-A-Captive-M6	255
Wallmounting H/w (set of 4)	BIL-A-WALLMOUNTHW	265

Notes : Packing & forwarding will be extra if accessories are ordered separately.

*List Prices are Ex-works Faridabad. For detail refer Enclosure Selling Terms & Conditions.

*GST to be charged extra

www.bchindia.com



Technical Particulars :

- Enclosure with In built hinges for front door
- Pad locking provision for front door
- Suitable for wall & pole mounting
- Front door locked with rust proof hardware
- Silicon Gasket between enclosure and front door for sealing
- Protection Category IP-67

Type-1 (Inbuilt Hinged Door Enclosure)

Box & Cover both in ABS		Box in ABS & Cover in PC(TR)		Box & Cover both in PC	
Cat No.	List Price [₹]	Cat No.	List Price [₹]	Cat No.	List Price [₹]
BIL-AB-1.01	1270	BIL-AP-1.01	1405	BIL-PC-1.01	1550
BIL-AB-1.02	1310	BIL-AP-1.02	1455	BIL-PC-1.02	1590
BIL-AB-1.03	1535	BIL-AP-1.03	1695	BIL-PC-1.03	1860
BIL-AB-1.04	1815	BIL-AP-1.04	2010	BIL-PC-1.04	2195
BIL-AB-1.05A	2570	BIL-AP-1.05A	2860	BIL-PC-105A	3150
BIL-AB-1.05B	2780	BIL-AP-1.05B	3085	BIL-PC-105B	3400
NA	-	NA	-	BIL-PC-1.06	13795

Technical Particulars :

- Plain walled enclosures came along with front removable Cover
- Rust proof polyamide screw for front cover
- Equipped with parallel inner bush ribs for din channels Self-tapping screws
- Silicon Gasket between enclosure and front cover for sealing
- Protection Category IP-67

Type-2 (Plain Walled Industrial Enclosure)

Box & Cover both in ABS		Box in ABS & Cover in PC(TR)		Box & Cover both in PC	
Cat No.	List Price [₹]	Cat No.	List Price [₹]	Cat No.	List Price [₹]
BIL-AB-2.00A	775	BIL-AP-2.00A	845	BIL-PC-2.00A	920
BIL-AB-2.01A	910	BIL-AP-2.01A	1000	BIL-PC-2.01A	1085
BIL-AB-2.01	1030	BIL-AP-2.01	1125	BIL-PC-2.01	1225
BIL-AB-2.02	1280	BIL-AP-2.02	1405	BIL-PC-2.02	1535
BIL-AB-2.03	1895	BIL-AP-2.03	2095	BIL-PC-2.03	2300
BIL-AB-2.04	2925	BIL-AP-2.04	3240	BIL-PC-2.04	3550
BIL-AB-2.04B	3735	BIL-AP-2.04B	4085	BIL-PC-2.04B	4435
BIL-AB-2.05A	5380	BIL-AP-2.05A	6040	BIL-PC-2.05A	6700
NA	-	NA	-	BIL-PC-2.05B	8175
NA	-	NA	-	BIL-PC-2.06	6645

Technical Particulars :

- Modular in nature and ideal for LV compartmentalized Panel
- Knock outs on box walls for bus bar and cables routing
- Molded silicon push lock jointing kits to maintain IP rating of enclosure After joining each other
- Silicon Gasket between enclosure and front cover for sealing
- Can be joined in modules to make any size of electrical LV panel
- Protection Category IP-67

Type-3 (Modular Panel Enclosure)

Box & Cover both in ABS		Box in ABS & Cover in PC(TR)		Box & Cover both in PC	
Cat No.	List Price [₹]	Cat No.	List Price [₹]	Cat No.	List Price [₹]
BIL-AB-3.01A	2030	BIL-AP-3.01A	2215	BIL-PC-3.01A	2400
BIL-AB-3.01B	2390	BIL-AP-3.01B	2610	BIL-PC-3.01B	2820
BIL-AB-3.02	3305	BIL-AP-3.02	3630	BIL-PC-3.02	3955
BIL-AB-3.03	4035	BIL-AP-3.03	4435	BIL-PC-3.03	4840
BIL-AB-3.04	4995	BIL-AP-3.04	5520	BIL-PC-3.04	6040

*List Prices are Ex-works Faridabad. For detail refer Enclosure Selling Terms & Conditions.

*GST to be charged extra

www.bchindia.com

Effective from 17.11.2025

Type-4 (Junction Boxes)

Technical Particulars :

- Equipped with multiple knockouts to accommodate different size of cables
- Front cover fixes with SS304 screws
- No of inner bush for din rail fixing
- Silicon Gasket between enclosure and front cover for sealing
- Outside bushes provided to mount box without tampering enclosures to maintain IP rating
- Protection Category IP-67

Box & Cover both in ABS		Box in ABS & Cover in PC(TR)		Box & Cover both in PC	
Cat No.	List Price [₹]	Cat No.	List Price [₹]	Cat No.	List Price [₹]
BIL-AB-4.01B	350	BIL-AP-4.01B	375	BIL-PC-4.01B	395
BIL-AB-4.02B	450	BIL-AP-4.02B	490	BIL-PC-4.02B	525
BIL-AB-4.03B	560	BIL-AP-4.03B	610	BIL-PC-4.03B	655
BIL-AB-4.04B	655	BIL-AP-4.04B	710	BIL-PC-4.04B	765
BIL-AB-4.05B	720	BIL-AP-4.05B	785	BIL-PC-4.05B	855
BIL-AB-4.06	880	BIL-AP-4.06	955	BIL-PC-4.06	1030
BIL-AB-4.07	1460	BIL-AP-4.07	1725	BIL-PC-4.07	1985

Type-5 (Power Distribution Boxes With Poly Carbonate Window)

Technical Particulars :

- Suitable for wall or Pole mounting
- Polycarbonate hinged window for easy operation of MCB
- Number of horizontal inner bush for din rail fixing
- Rust proof SS304 screw for front cover fixing
- Silicon Gasket between enclosure and front cover for sealing
- Front cover fixed with rust proof SS304 screws
- Protection Category IP-65

Box & Cover both in ABS		Box in ABS & Cover in PC(TR)		Box & Cover both in PC	
Cat No.	List Price [₹]	Cat No.	List Price [₹]	Cat No.	List Price [₹]
NA	-	BIL-AP-5.01 Eco	890	NA	-
NA	-	BIL-AP-5.01B Eco	805	NA	-
NA	-	BIL-AP-5.01	1255	NA	-
NA	-	BIL-AP-5.02 Eco	1145	NA	-
NA	-	BIL-AP-5.02B Eco	1010	NA	-
NA	-	BIL-AP-5.02	1625	NA	-
NA	-	BIL-AP-5.03	2075	NA	-
NA	-	BIL-AP-5.04	2530	NA	-
NA	-	BIL-AP-5.05 A	3745	NA	-
NA	-	BIL-AP-5.05	4630	NA	-
NA	-	BIL-AP-5.06	6620	NA	-

Type-6 (Enclosure With External Mounting)

Technical Particulars :

- Provision of outside mounting on enclosure
- Suitable for heavy duty application like Bus bars, industrial plugs sockets & Solar application
- Number of horizontal inner bush for din rail fixing
- Rust proof SS304 screw for front cover fixing
- Silicon Gasket between enclosure and front cover for sealing
- Protection Category IP-67

Box & Cover both in ABS		Box in ABS & Cover in PC(TR)		Box & Cover both in PC	
Cat No.	List Price [₹]	Cat No.	List Price [₹]	Cat No.	List Price [₹]
BIL-AB-6.01	430	NA	-	NA	-
BIL-AB-6.02A	560	BIL-AP-6.02A	605	NA	-
BIL-AB-6.02B	665	BIL-AP-6.02B	720	NA	-
BIL-AB-6.03	575	BIL-AP-6.03	620	NA	-
BIL-AB-6.04	795	NA	-	NA	-
BIL-AB-6.05	1085	NA	-	NA	-
BIL-AB-6.06A	965	BIL-AP-6.06A	1040	NA	-
BIL-AB-6.06B	1200	BIL-AP-6.06B	1300	NA	-
BIL-AB-6.07	1690	BIL-AP-6.07	1870	NA	-
BIL-AB-6.08	2725	NA	-	NA	-
BIL-AB-6.09	3865	NA	-	NA	-

*List Prices are Ex-works Faridabad. For detail refer Enclosure Selling Terms & Conditions.

*GST to be charged extra

www.bchindia.com

Type-7 (Enclosure With External Mounting)

Technical Particulars :

- Specially designed for IT, electronics and automation industrial solutions
- Available in 31 different sizes
- Provision of PCB & Electronics component mounting
- Rust proof SS304 screw for front cover fixing
- Silicon Gasket between enclosure and front door for sealing
- Suitable for wall & pole mounting
- Protection Category IP-67

Box & Cover both in ABS		Box in ABS & Cover in PC(TR)		Box & Cover both in PC	
Cat No.	List Price [₹]	Cat No.	List Price [₹]	Cat No.	List Price [₹]
BIL-AB-7.01	305	NA	-	BIL-PC-7.01	340
BIL-AB-7.02	460	BIL-AP-7.02	500	NA	-
BIL-AB-7.03	350	NA	-	NA	-
BIL-AB-7.04	450	NA	-	NA	-
BIL-AB-7.05	560	BIL-AP-7.05	615	NA	-
BIL-AB-7.06A	395	NA	-	NA	-
BIL-AB-7.06B	515	NA	-	NA	-
BIL-AB-7.07	720	BIL-AP-7.07	785	NA	-
BIL-AB-7.07B	600	BIL-AP-7.07B	635	NA	-
BIL-AB-7.08	600	NA	-	NA	-
BIL-AB-7.08A	820	BIL-AP-7.08A	900	BIL-PC-7.08A	975
BIL-AB-7.08C	910	BIL-AP-7.08C	995	BIL-PC-7.08C	1075
BIL-AB-7.09A	710	NA	-	NA	-
BIL-AB-7.09B	775	NA	-	NA	-
BIL-AB-7.10A	840	BIL-AP-7.10A	On request	BIL-PC-7.10A	935
BIL-AB-7.10B	830	NA	-	BIL-PC-7.10B	1010
BIL-AB-7.11	460	NA	-	NA	-
BIL-AB-7.12	880	NA	-	NA	-
BIL-AB-7.13	865	NA	-	NA	-
BIL-AB-7.13A	775	NA	-	NA	-
BIL-AB-7.14	900	NA	-	NA	-
BIL-AB-7.15	890	NA	-	NA	-
BIL-AB-7.16	1840	NA	-	NA	-
BIL-AB-7.18	1515	BIL-AP-7.18	1660	BIL-PC-7.18	1805
BIL-AB-7.19	1065	NA	-	NA	-
BIL-AB-7.20	2345	NA	-	NA	-
BIL-AB-7.01L	280	BIL-AP-7.01L	300	NA	-
BIL-AB-7.02L	405	BIL-AP-7.02L	435	BIL-PC-7.02L	460
BIL-AB-7.03L	675	BIL-AP-7.03L	720	NA	-



*List Prices are Ex-works Faridabad. For detail refer Enclosure Selling Terms & Conditions.

***GST to be charged extra**

www.bchindia.com

Wires & Cables

- **3-Core Flat Cables for Submersible Pump Applications**
- **FR & FRLS Single Core Flexible Cables**
- **Multi Core PVC Flexible Cables**
- **Shielded Cables**
- **Steel Braided Cable**



BCH Three Core Flat Cables with annealed bare & bunched copper conductor insulated & sheathed with PVC for submersible pump motors for voltage grade 1100 V as per I.S. 694 / 2010, conforming & marked with I.S. 694 / 2010 upto 95 sqmm. 3 Core Flat Cable PVC Insulated Type CS

HSN Code : 8544

BCH Code	Flat Cable	LP Per 500 Mtrs in [₹]	Remark
CS0010BM	1.0 Sqmm x 3 core Flat cable	On request	Also Available in 100 mtrs,500 mtrs 1000 mtrs in drum as well as in wrap packing
CS0015BM	1.5 Sqmm x 3 core Flat cable	On request	
CS0025BM	2.5 Sqmm x 3 core Flat cable	On request	
CS0040BM	4.0 Sqmm x 3 core Flat cable	On request	
CS0060BM	6.0 Sqmm x 3 core Flat cable	On request	
CS0080BM	8.0 Sqmm x 3 core Flat cable	On request	
CS0100BM	10 Sqmm x 3 core Flat cable	On request	
CS0160BM	16 Sqmm x 3 core Flat cable	On request	
CS0250BM	25 Sqmm x 3 core Flat cable	On request	
CS0350BM	35 Sqmm x 3 core Flat cable	On request	
CS0500BM	50 Sqmm x 3 core Flat cable	On request	
CS0700BM	70 Sqmm x 3 core Flat cable	On request	
CS0950BM	95 Sqmm x 3 core Flat cable	On request	
CS1200BM	120 Sqmm x 3 core Flat cable	On request	



BCH Three Core Flat Cables with XLPE insulation & ROHS PVC sheath for withstanding temperature upto 90 deg.C.

HSN Code : 8544

BCH Code	FLAT CS XLPE CABLE	LP Per 500 Mtrs in	Remark
CFTEX-03-0015BM	1.5 Sq. mm x 3 core Flat CS XLPE CABLE	On request	Also Available in 100 mtrs,500 mtrs 1000 mtrs in drum as well as in wrap packing
CFTEX-03-0025BM	2.5 Sq. mm x 3 core Flat CS XLPE CABLE	On request	
CFTEX-03-0040BM	4.0 Sq. mm x 3 core Flat CS XLPE CABLE	On request	
CFTEX-03-0060BM	6.0 Sq. mm x 3 core Flat CS XLPE CABLE	On request	
CFTEX-03-0080BM	8.0 Sq. mm x 3 core Flat CS XLPE CABLE	On request	
CFTEX-03-0100BM	10 Sq. mm x 3 core Flat CS XLPE CABLE	On request	
CFTEX-03-0160BM	16 Sq. mm x 3 core Flat CS XLPE CABLE	On request	
CFTEX-03-0250BM	25 Sq. mm x 3 core Flat CS XLPE CABLE	On request	
CFTEX-03-0350BM	35 Sq. mm x 3 core Flat CS XLPE CABLE	On request	
CFTEX-03-0500BM	50 Sq. mm x 3 core Flat CS XLPE CABLE	On request	



BCH Three Core Flat Cables with XLPE insulation & ROHS PVC sheath for withstanding temperature upto 90 deg.C.

HSN Code : 8544

BCH Code	Flat Cable	LP Per 500 Mtrs in [₹]	Remark
CFTX-03-0015BM	1.5 Sqmm x 3 core Flat cable XLPE insulated Thick	On request	Also Available in 100 mtrs,500 mtrs 1000 mtrs in drum as well as in wrap packing
CFTX-03-0025BM	2.5 Sqmm x 3 core Flat cable XLPE insulated Thick	On request	
CFTX-03-0040BM	4.0 Sqmm x 3 core Flat cable XLPE insulated Thick	On request	
CFTX-03-0060BM	6.0 Sqmm x 3 core Flat cable XLPE insulated Thick	On request	
CFTX-03-0080BM	8.0 Sqmm x 3 core Flat cable XLPE insulated Thick	On request	
CFTX-03-0100BM	10 Sqmm x 3 core Flat cable XLPE insulated Thick	On request	
CFTX-03-0160BM	16 Sqmm x 3 core Flat cable XLPE insulated Thick	On request	



Note:

At the end of every code "A" stand for 100 mtrs. , "BM" stand for 500 mtrs. , "CM" stand for 1000 mtrs.

For price, please contact our nearest sales office.

Single Core FR PVC Flexible Cables As Per IS 694: 2010 - With ISI Marking

HSN Code : 8544

- Individual conductors drawn from 99.98% bright electrolytic grade copper with more than 100% conductivity
- Special formulation of PVC compounds as per IS 5831:2013 ensures longer and trouble free service life.
- Use only RoHS insulation and sheathing compounds. Ensures cleaner environment and better health.
- Online measurement and monitoring of O.D., core dia and dielectric strength.
- Suitable for -15 to +70°C.
- Flame Retardent

Cat. No.	Conductor Area (nominal)	Safe Current Carrying Capacity 2 wires, Single Phase		LP Per 100 mtrs
		In conduit / Trunking	Unenclosed clipped directly to a surface or on cable tray	
Single Core	(Sq. mm)	(Amp.)	(Amp.)	in [₹]
CRFR01-0005A-AAA	0.5	4	4.5	On request
CRFR01-0008A-AAA	0.75	7	8	On request
CRFR01-0010A-AAA	1	11	12	On request
CRFR01-0015A-AAA	1.5	13	16	On request
CRFR01-0025A-AAA	2.5	18	22	On request
CRFR01-0040A-AAA	4	24	29	On request
CRFR01-0060A-AAA	6	31	37	On request
CRFR01-0100A-AAA	10	42	51	On request
CRFR01-0160A-AAA	16	57	68	On request
CRFR01-0250A-AAA	25	71	86	On request
CRFR01-0350A-AAA	35	91	100	On request
CRFR01-0500A-AAA	50	120	145	On request
CRFR01-0700A-AAA	70	-	214	On request
CRFR01-0950A-AAA	95	-	260	On request
CRFR01-1200A-AAA	120	-	305	On request
CRFR01-1500A-AAA	150	-	355	On request
CRFR01-1850A-AAA	185	-	415	On request
CRFR01-2400A-AAA	240	-	500	On request
CRFR01-3000A-AAA	300	-	560	On request

Individual conductors drawn from 99.98% bright electrolytic grade copper with more than 100% conductivity
 Note : Standard packing of 100m, 500m & 1000m available. For price of 500m & 1000m , please contact nearest sales office.

Single Core Double Insulation FR PVC Flexible Cables As Per IS 694: 2010 - With ISI Marking

HSN Code : 8544

- Glossy & smooth surface finish
- Anti Rodent properties
- Lead free
- Energy saving



Cat. No.	Conductor Area (nominal)	Safe Current Carrying Capacity 2 wires, Single Phase		LP Per 90 / 100 mtrs
		In conduit / Trunking	Unenclosed clipped directly to a surface or on cable tray	
Single Core	(Sq. mm)	(Amp.)	(Amp.)	in [₹]
CRDFR01-0005D-AAA	0.5	4	4.5	On request
CRDFR01-0008D-AAA	0.75	7	8	On request
CRDFR01-0010D-AAA	1	11	12	On request
CRDFR01-0015D-AAA	1.5	13	16	On request
CRDFR01-0025D-AAA	2.5	18	22	On request
CRDFR01-0040D-AAA	4	24	29	On request
CRDFR01-0060D-AAA	6	31	37	On request

Note: Standard packing of 90m, 180m & 270m available. For prices of 90m, 180m & 270m, please contact nearest sales office.

Single Core FRLS Flexible Cables As Per IS 694: 2010-With ISI Marking

HSN Code : 8544



Cat. No.	Conductor Area (nominal)	Safe Current Carrying Capacity 2 wires		LP Per 90 mtrs
		In conduit / Trunking	Unenclosed clipped directly to a surface or on cable tray	
Single Core	(Sq. mm)	(Amp.)	(Amp.)	in [₹]
CRLS01-0005A-AAA	0.5	4	4.5	On request
CRLS01-0008A-AAA	0.75	7	8	On request
CRLS01-0010A-AAA	1	11	12	On request
CRLS01-0015A-AAA	1.5	13	16	On request
CRLS01-0025A-AAA	2.5	18	22	On request
CRLS01-0040A-AAA	4	24	29	On request
CRLS01-0060A-AAA	6	31	37	On request
CRLS01-0100A-AAA	10	42	51	On request
CRLS01-0160A-AAA	16	57	68	On request
CRLS01-0250A-AAA	25	71	86	On request
CRLS01-0350A-AAA	35	91	100	On request
CRLS01-0500A-AAA	50	120	145	On request

Note: Standard packing of 100m, 180m & 270m available. For prices of 100m, 180m & 270m, please contact nearest sales office.
 All sizes will be in 100 mtrs packing

Multi Core PVC Flexible Cables

HSN Code : 8544

Conductor area (Normal)	Cat. No. 2 Core	LP per 100 Mtrs	Cat. No. 3 Core	LP per 100 Mtrs	Cat. No. 4 Core	LP per 100 Mtrs	Current Rating (Amps)
0.5 sqmm	CR02-0005A-AAA-M	On request	CR03-0005A-AAA-M	On request	CR04-0005A-AAA-M	On request	4
0.75 sqmm	CR02-0008A-AAA-M	On request	CR03-0008A-AAA-M	On request	CR04-0008A-AAA-M	On request	7
1.0 sqmm	CR02-0010A-AAA-M	On request	CR03-0010A-AAA-M	On request	CR04-0010A-AAA-M	On request	12
1.5 sqmm	CR02-0015A-AAA-M	On request	CR03-0015A-AAA-M	On request	CR04-0015A-AAA-M	On request	15
2.5 sqmm	CR02-0025A-AAA-M	On request	CR03-0025A-AAA-M	On request	CR04-0025A-AAA-M	On request	20
4.0 sqmm	CR02-0040A-AAA-M	On request	CR03-0040A-AAA-M	On request	CR04-0040A-AAA-M	On request	27
6.0 sqmm	CR02-0060A-AAA-M	On request	CR03-0060A-AAA-M	On request	CR04-0060A-AAA-M	On request	35
10 sqmm	CR02-0100A-AAA-M	On request	CR03-0100A-AAA-M	On request	CR04-0100A-AAA-M	On request	46
16 sqmm	CR02-0160A-AAA-M	On request	CR03-0160A-AAA-M	On request	CR04-0160A-AAA-M	On request	62
25 sqmm	CR02-0250A-AAA-M	On request	CR03-0250A-AAA-M	On request	CR04-0250A-AAA-M	On request	80
35 sqmm	CR02-0350A-AAA-M	On request	CR03-0350A-AAA-M	On request	CR04-0350A-AAA-M	On request	102
50 sqmm	CR02-0500A-AAA-M	On request	CR03-0500A-AAA-M	On request	CR04-0500A-AAA-M	On request	138

Conductor area (Normal)	Cat. No. 5 Core	LP per 100 Mtrs	Cat. No. 6 Core	LP per 100 Mtrs	Cat. No. 7 Core	LP per 100 Mtrs	Current Rating (Amps)
0.5 sqmm	CR05-0005A-AAA-M	On request	CR06-0005A-AAA-M	On request	CR07-0005A-NAA-M	On request	4
0.75 sqmm	CR05-0008A-AAA-M	On request	CR06-0008A-AAA-M	On request	CR07-0008A-NAA-M	On request	7
1.0 sqmm	CR05-0010A-AAA-M	On request	CR06-0010A-AAA-M	On request	CR07-0010A-NAA-M	On request	12
1.5 sqmm	CR05-0015A-AAA-M	On request	CR06-0015A-AAA-M	On request	CR07-0015A-NAA-M	On request	15
2.5 sqmm	CR05-0025A-AAA-M	On request	CR06-0025A-AAA-M	On request	CR07-0025A-NAA-M	On request	20
4.0 sqmm	CR05-0040A-AAA-M	On request	CR06-0040A-AAA-M	On request	CR07-0040A-NAA-M	On request	27
6.0 sqmm	CR05-0060A-AAA-M	On request					35

Conductor area (Normal)	Cat. No. 8 Core	LP per 100 Mtrs	Cat. No. 10 Core	LP per 100 Mtrs	Cat. No. 12 Core	LP per 100 Mtrs	Current Rating (Amps)
0.5 sqmm	CR08-0005A-NAA-M	On request	CR10-0005A-NAA-M	On request	CR12-0005A-NAA-M	On request	4
0.75 sqmm	CR08-0008A-NAA-M	On request	CR10-0008A-NAA-M	On request	CR12-0008A-NAA-M	On request	7
1.0 sqmm	CR08-0010A-NAA-M	On request	CR10-0010A-NAA-M	On request	CR12-0010A-NAA-M	On request	12
1.5 sqmm	CR08-0015A-NAA-M	On request	CR10-0015A-NAA-M	On request	CR12-0015A-NAA-M	On request	15
2.5 sqmm	CR08-0025A-NAA-M	On request	CR10-0025A-NAA-M	On request	CR12-0025A-NAA-M	On request	20
4.0 sqmm	CR08-0040A-NAA-M	On request	CR10-0040A-NAA-M	On request	CR12-0040A-NAA-M	On request	27

Conductor area (Normal)	Cat. No. 14 Core	LP per 100 Mtrs	Cat. No. 16 Core	LP per 100 Mtrs	Cat. No. 19 Core	LP per 100 Mtrs	Current Rating (Amps)
0.5 sqmm	CR14-0005A-NAA-M	On request	CR16-0005A-NAA-M	On request	CR19-0005A-NAA-M	On request	4
0.75 sqmm	CR14-0008A-NAA-M	On request	CR16-0008A-NAA-M	On request	CR19-0008A-NAA-M	On request	7
1.0 sqmm	CR14-0010A-NAA-M	On request	CR16-0010A-NAA-M	On request	CR19-0010A-NAA-M	On request	12
1.5 sqmm	CR14-0015A-NAA-M	On request	CR16-0015A-NAA-M	On request	CR19-0015A-NAA-M	On request	15
2.5 sqmm	CR14-0025A-NAA-M	On request	CR16-0025A-NAA-M	On request	CR19-0025A-NAA-M	On request	20
4.0 sqmm	CR14-0040A-NAA-M	On request	CR16-0040A-NAA-M	On request	CR19-0040A-NAA-M	On request	27

Conductor area (Normal)	Cat. No. 24 Core	LP per 100 Mtrs	Cat. No. 25 Core	LP per 100 Mtrs	Cat. No. 30 Core	LP per 100 Mtrs	Current Rating (Amps)
0.5 sqmm	CR24-0005A-NAA-M	On request	CR25-0005A-NAA-M	On request	CR30-0005A-NAA-M	On request	4
0.75 sqmm	CR24-0008A-NAA-M	On request	CR25-0008A-NAA-M	On request	CR30-0008A-NAA-M	On request	7
1.0 sqmm	CR24-0010A-NAA-M	On request	CR25-0010A-NAA-M	On request	CR30-0010A-NAA-M	On request	12
1.5 sqmm	CR24-0015A-NAA-M	On request	CR25-0015A-NAA-M	On request	CR30-0015A-NAA-M	On request	15
2.5 sqmm	CR24-0025A-NAA-M	On request	CR25-0025A-NAA-M	On request	CR30-0025A-NAA-M	On request	20
4.0 sqmm	CR24-0040A-NAA-M	On request	CR25-0040A-NAA-M	On request	CR30-0040A-NAA-M	On request	27

Conductor area (Normal)	Cat. No. 36 Core	LP per 100 Mtrs	Current Rating (Amps)
0.5 sqmm	CR36-0005A-NAA-M	On request	4
0.75 sqmm	CR36-0008A-NAA-M	On request	7
1.0 sqmm	CR36-0010A-NAA-M	On request	12
1.5 sqmm	CR36-0015A-NAA-M	On request	15
2.5 sqmm	CR36-0025A-NAA-M	On request	20
4.0 sqmm	CR36-0040A-NAA-M	On request	27

The conductor construction given above is indicative only and will be such that all requirements of strand diameter and conductor resistance as per IS 694:2010 and IS 8130:2013 are met.

Sizes 0.5 to 50 Sq. mm from 2 to 4 cores & 0.5 to 2.5 Sq. mm upto 24 Core with ISI mark, rest all generally conforming to the IS Standard. packing available in 100 meter coils, longer lengths on drums (500m to 1000m)

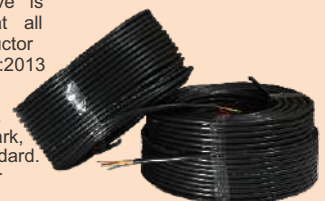

BCH Annealed Bare Cu Flexible Conductor PVC Insulated, TinnedCuBraided(Screened) PVC Sheathed Flexible Unarmoured Cables FOR VOLTAGE

HSN Code : 8544

Conductor area (Normal)	Cat. No. 2 Core	LP per 100 Mtrs	Cat. No. 3 Core	LP per 100 Mtrs	Current Rating (Amps)
0.5 sqmm	CRSCY02-0005A-EAA	On request	CRSCY03-0005A-EAA	On request	4
0.75 sqmm	CRSCY02-0008A-EAA	On request	CRSCY03-0008A-EAA	On request	7
1.0 sqmm	CRSCY02-0010A-EAA	On request	CRSCY03-0010A-EAA	On request	12
1.5 sqmm	CRSCY02-0015A-EAA	On request	CRSCY03-0015A-EAA	On request	15
2.5 sqmm	CRSCY02-0025A-EAA	On request	CRSCY03-0025A-EAA	On request	20



Conductor area (Normal)	Cat. No. 4 Core	LP per 100 Mtrs	Cat. No. 5 Core	LP per 100 Mtrs	Current Rating (Amps)
0.5 sqmm	CRSCY04-0005A-EAA	On request	CRSCY05-0005A-EAA	On request	4
0.75 sqmm	CRSCY04-0008A-EAA	On request	CRSCY05-0008A-EAA	On request	7
1.0 sqmm	CRSCY04-0010A-EAA	On request	CRSCY05-0010A-EAA	On request	12
1.5 sqmm	CRSCY04-0015A-EAA	On request	CRSCY05-0015A-EAA	On request	15
2.5 sqmm	CRSCY04-0025A-EAA	On request	CRSCY05-0025A-EAA	On request	20

Conductor area (Normal)	Cat. No. 6 Core	LP per 100 Mtrs	Cat. No. 7 Core	LP per 100 Mtrs	Current Rating (Amps)
0.5 sqmm	CRSCY06-0005A-EAA	On request	CRSCY07-0005A-EAA	On request	4
0.75 sqmm	CRSCY06-0008A-EAA	On request	CRSCY07-0008A-EAA	On request	7
1.0 sqmm	CRSCY06-0010A-EAA	On request	CRSCY07-0010A-EAA	On request	12
1.5 sqmm	CRSCY06-0015A-EAA	On request	CRSCY07-0015A-EAA	On request	15
2.5 sqmm	CRSCY06-0025A-EAA	On request	CRSCY07-0025A-EAA	On request	20

BCH Flex Bare Copper Conductor, PVC Insulated, Cores Laid Up Together PVC Inner Sheathed, GI Wire Braided (Flexible Armouring), Overall Transparent PVC Sheathed Cable FOR VOLTAGE GRADE UPTO 1100 V CONFORMING TO IS-694:2010.

HSN Code : 8544

Conductor area (Normal)	Cat. No. 2 Core	LP per 100 Mtrs	Cat. No. 3 Core	LP per 100 Mtrs	Current Rating (Amps)
0.5 sqmm	CRSY02-0005A-AAA-M	On request	CRSY03-0005A-AAA-M	On request	4
0.75 sqmm	CRSY02-0008A-AAA-M	On request	CRSY03-0008A-AAA-M	On request	7
1.0 sqmm	CRSY02-0010A-AAA-M	On request	CRSY03-0010A-AAA-M	On request	12
1.5 sqmm	CRSY02-0015A-AAA-M	On request	CRSY03-0015A-AAA-M	On request	15
2.5 sqmm	CRSY02-0025A-AAA-M	On request	CRSY03-0025A-AAA-M	On request	20

Conductor area (Normal)	Cat. No. 4 Core	LP per 100 Mtrs	Cat. No. 5 Core	LP per 100 Mtrs	Current Rating (Amps)
0.5 sqmm	CRSY04-0005A-AAA-M	On request	CRSY05-0005A-AAA-M	On request	4
0.75 sqmm	CRSY04-0008A-AAA-M	On request	CRSY05-0008A-AAA-M	On request	7
1.0 sqmm	CRSY04-0010A-AAA-M	On request	CRSY05-0010A-AAA-M	On request	12
1.5 sqmm	CRSY04-0015A-AAA-M	On request	CRSY05-0015A-AAA-M	On request	15
2.5 sqmm	CRSY04-0025A-AAA-M	On request	CRSY05-0025A-AAA-M	On request	20



Conductor area (Normal)	Cat. No. 6 Core	LP per 100 Mtrs	Cat. No. 7 Core	LP per 100 Mtrs	Current Rating (Amps)
0.5 sqmm	CRSY06-0005A-AAA-M	On request	CRSY07-0005A-AAA-M	On request	4
0.75 sqmm	CRSY06-0008A-AAA-M	On request	CRSY07-0008A-AAA-M	On request	7
1.0 sqmm	CRSY06-0010A-AAA-M	On request	CRSY07-0010A-AAA-M	On request	12
1.5 sqmm	CRSY06-0015A-AAA-M	On request	CRSY07-0015A-AAA-M	On request	15
2.5 sqmm	CRSY06-0025A-AAA-M	On request	CRSY07-0025A-AAA-M	On request	20

Power Quality & Energy Management

- LT Power Capacitors - Cylindrical Type
- LT Power Capacitors - Box Type
- Super Heavy Duty Box Type Capacitor
- Automatic Power Factor Controllers (APFC) & Intelligent Power Factor Controllers (IPFC)
- Detuned Reactors



MPP Can type capacitors



MPP Can Type Capacitors(with ISI Mark) (440V)

HSN Code : 8532

KVAR	Normal Duty		Heavy Duty	
	Cat. No.	MRP [₹]	Cat. No.	MRP [₹]
1	BCHMCN001B	405	BCHMCH001B	585
2	BCHMCN002B	805	BCHMCH002B	1160
3	BCHMCN003B	1200	BCHMCH003B	1735
4	BCHMCN004B	1615	BCHMCH004B	2310
5	BCHMCN005B	1950	BCHMCH005B	2620
7.5	BCHMCN007B	2915	BCHMCH007B	3925
10	BCHMCN010B	3490	BCHMCH010B	4835
12.5	BCHMCN012B	4375	BCHMCH012B	6045
15	BCHMCN015B	5235	BCHMCH015B	7255
20	BCHMCN020B	6980	BCHMCH020B	9680
25	BCHMCN025B	8725	BCHMCH025B	12085

Price of 480V & 525V Capacitors available on request.

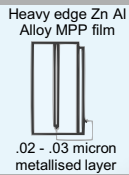

MPP Capacitors (IS13340)

MPP capacitors are manufactured using Zn-Al metallized polypropylene film. These modules are provided with pressure interrupter arrangement for safety against bursting due to internal pressure arised due to prolonged high voltage / current. The modules are assembled in aluminium case or CRCA container

MPP Box Type Capacitors(with ISI Mark) (440V)

HSN Code : 8532



KVAR	Normal Duty		Heavy Duty	
	Cat. No.	MRP [₹]	Cat. No.	MRP [₹]
1	BCHMBN001B	465	BCHMBH001B	585
2	BCHMBN002B	910	BCHMBH002B	1160
3	BCHMBN003B	1360	BCHMBH003B	1735
4	BCHMBN004B	1805	BCHMBH004B	2320
5	BCHMBN005B	2120	BCHMBH005B	2725
7.5	BCHMBN007B	3190	BCHMBH007B	4080
10	BCHMBN010B	4220	BCHMBH010B	5425
12.5	BCHMBN012B	5300	BCHMBH012B	6790
15	BCHMBN015B	6350	BCHMBH015B	8145
20	BCHMBN020B	8455	BCHMBH020B	10870
25	BCHMBN025B	10565	BCHMBH025B	13590

Price of 480V & 525V Capacitors available on request.



Double thick
double hazy pp film

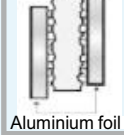

APP Capacitors

Non self healing APP capacitors manufactured using double hazy and double thick polypropylene films between two electrodes of thick aluminium foil have extended foil construction to ensure low watt losses

APP Box Type Single Layer Capacitors & Super Heavy Duty Box Type Capacitors (with ISI Mark) (440V)

HSN Code : 8532

KVAR	APP Capacitor		SHD Capacitor	
	Cat. No.	MRP [₹]	Cat. No.	MRP [₹]
1	BCHAPS001B	1205	BCHSHD001B	2385
2	BCHAPS002B	2385	BCHSHD002B	4730
3	BCHAPS003B	3560	BCHSHD003B	7085
4	BCHAPS004B	4735	-	-
5	BCHAPS005B	5760	BCHSHD005B	10115
7.5	BCHAPS007B	8010	BCHSHD007B	15183
10	BCHAPS010B	10690	BCHSHD010B	20242
12.5	BCHAPS012B	13375	BCHSHD012B	25291
15	BCHAPS015B	16030	BCHSHD015B	30350
20	BCHAPS020B	21385	BCHSHD020B	40474
25	BCHAPS025B	26745	BCHSHD025B	50582

Price of 480V & 525V Capacitors available on request.

7% Aluminium wound & Copper wound 440V Detuned Reactors

HSN Code : 8504

KVAR	Aluminium wound		Copper wound	
	Cat. No.	MRP [₹]	Cat. No.	MRP [₹]
5	BCHRAL005B	On request	BCHRCU005B	On request
10	BCHRAL010B	On request	BCHRCU010B	On request
15	BCHRAL015B	On request	BCHRCU015B	On request
20	BCHRAL020B	On request	BCHRCU020B	On request
25	BCHRAL025B	On request	BCHRCU025B	On request
50	BCHRAL050B	On request	BCHRCU050B	On request
75	BCHRAL075B	On request	BCHRCU075B	On request
100	BCHRAL100B	On request	BCHRCU100B	On request



Price for 14% Aluminium & Copper bound reactor available on request

APFC Relay

Intelligent Power Factor Controllers (IPFC)

Steps	Cat. No.	Voltage	Brief description	MRP [₹]
12 STEP - 3φ	RG3-12C	230V	12 Step intelligent PFC	44270
12 STEP - 3φ	RG3-12CS	230V	12 Step intelligent PFC with RS 485 communication	49788
15 STEP - 3φ	RG3-15C	230V	15 Step , Intelligent PFC relay	46396
15 STEP - 3φ	RG3-15CL	230V	15 Step , Intelligent PFC relay with 3 steps for reactor	On request
15 STEP - 3φ	RG3-15CS	230V	15 Step , Intelligent PFC relay with RS485 communication	56130
15 STEP - 3φ	RG3-15CLS	230V	15 Step , Intelligent PFC relay with 3 steps for reactor and RS485 communication	On request

Note : **RG3-8/12/15 and RG3-12/15CS available in 230V only



- 3-Phase / 3CTs
- Connecting Single-Phase & 3-Phase Capacitors
- Compensation of Each Phase
- Measures : A, Cos-Ø, Total W, Total VAR, Total VA, Total KWH, Total KVArh
- Harmonic Measurement (up to 19th)
- THD 1% THD V%
- Programmable THD Protection
- Programmable Discharge Time
- Programmable THD Alarm
- Password Protection for setup
- Overheat Protection (Optional)
- RS-485 Communication (Optional)
- RG-15C - Intelligent relay PFC with smart switching with all 15 steps relay connection
- RG-15C - Intelligent relay PFC with smart switching with all 15 steps relay connection with communication

Automatic Power Factor Controllers (APFC)

Steps	Cat. No.	Voltage	Brief description	MRP [₹]
6 STEP - 1 φ	RG-6T-230-96	230V	PFC (96X96) WITH 6 STEPS , 230 V	17155
6 STEP - 1 φ	RG-6T-415-96	415V	PFC (96X96) WITH 6 STEPS , 415 V	17155
6 STEP - 1 φ	RG-6T-230	230V	PFC (144X144) WITH 6 STEPS, 230 V	17925
6 STEP - 1 φ	RG-6T-415	415V	PFC (144X144) WITH 6 STEPS, 415 V	17925
8 STEP - 1 φ	RG-8T-230	230V	PFC (144X144) WITH 8 STEPS, 230 V	20375
8 STEP - 1 φ	RG-8T-415	415V	PFC (144X144) WITH 8 STEPS, 415 V	20375
8 STEP - 3 φ	RG3-8T-230	230V	PFC 144X144, 8 STEPS, 230V UNBALANCE LOAD	27380
12 STEP - 1 φ	RG-12T-230	230V	PFC (144X144) WITH 12 STEPS, 230 V	25515
12 STEP - 1 φ	RG-12T-415	415V	PFC (144X144) WITH 12 STEPS, 415 V	25515
12 STEP - 3 φ	RG3-12T-230	230V	PFC 144X144, 12 STEPS, 230V UNBALANCE LOAD	33160

Note : **RG3-8/12/15 and RG3-12/15CS available in 230V only



Thyristor Switched Module with Visual Circuit Indicator

HSN Code : 8538

KVAR	Type	Rated Voltage (V)	Cat. No.	MRP [₹]
5	TSM	440	BCHTSM005	On request
10	TSM	440	BCHTSM010	On request
15	TSM	440	BCHTSM015	On request
20	TSM	440	BCHTSM020	On request
25	TSM	440	BCHTSM025	On request
50	TSM	440	BCHTSM050	On request
75	TSM	440	BCHTSM075	On request
100	TSM	440	BCHTSM100	On request

Electric Motors

IE2, IE3 & IE4

50°C
ambient temperature



- Wide Range
- Range: 0.16 HP to 425 HP
- Robust Design - IE2/IE3/IE4 Versions
- Dynamically Balanced Motors
- Corrosion-Resistant Stator Frames
- High Efficient Stator Laminations With Superior Low Loss CRNGO Steel
- Full Tropicalised Design for Indian Conditions
- Class F Insulation
- Six Terminal Terminal Box Across the Range
- Various Mounting Possibilities
- Superior Aesthetics - RAL-5014 Paint Shade As Standard
- Customised Motore Design Capability
- Compatible A.C Drive & Soft Starter Range
- Nationwide sales & service network



Crane Duty Motors
Power: 0.18 to 200.0 kW



Brake Motors
Power: 0.12 to 55.0 kW



Multi Speed Motors
Power: 0.12 to 150.0 kW



Duplex Cooling Motors
Power: 160.0 to 500.0 kW



Fire Fighting Motors
Power: 3.7 to 250.0 kW

- Manufacturing in Quality Assurance System Compliant With ISO 9001

Switchboards & Solutions

- **MCC & PCC**
- **APFC Panels**
- **Crane Control Panels**
- **Punch Grid Resistors & Panels, NGR & DBR**
- **Special Purpose Starters**
- **Power Receptacles**
- **Auto Transformer Starters**



Motor Control Centres (MCC) & Power Control Centres (PCC)



SWITCHBOARD DATA SHEET

BCH Switchboards are manufactured at Faridabad works complying to latest design standard & manufacturing processes, with inhouse powder coating paint shop, gasketing shop, fabrication shop equipped with AMADA punching & bending machines. Switchboards are modular in design, metal clad, free standing, air insulated, floor mounted & compartmentalized type suitable for most critical and rugged indoor/outdoor application & tough industrial environment.

TECHNICAL DATA

Standard & Specification

Power Switchgear & Controlgear assembly as per IEC 61439 - 1 & 2

- Short circuit Test - Bus-bar system designed for 50 KA rms / 1sec, and peak fault withstanding Strength 105 KA & 65KA rms/1sec & 143KA peak fault withstand as per IS: 8623 and IEC: 61439
- Temperature rise - Panel tested for 800 A to 4000 A from CPRI Bhopal as per IS: 8623 and IEC: 61439
- Impulse withstand test - Rated impulse withstand test for 8Kv from CPRI, Bangalore as per Sub clause 10.9 of IEC 61439-1 & 2
- Seismic Zone & Resonance search test - As per IEE693:2018, PERFORMANCE LEVEL ZPA0.5g

Product range

- PCC upto 6300A- Single Tire/Two Tire/Three Tire version
- PMCC/IMCC/CMCC- Fixed/drawout version
- Power Distribution Panel / Lighting panel

Electrical Data

- Rated insulation voltage (Ui) 1000V
- Rated operating voltage (Ue) Upto 690V
- Rated impulse withstand voltage (Uimp) 8KV
- Rated frequency (fn) 50 / 60 Hz

Main Horizontal Bus Bar -

Aluminum grade E 91E as per IS:5082 & Electrolytic grade Copper Bus-bars

- Rated current (Ie) Up to 6300 A
- Rated peak withstand current (Ipk) Up to 220 KA
- Rated short-time withstand current (Icw) Up to 80 KA-1sec

Vertical Distribution Bus Bar

- Rated current (Ie) up to 2000 A
- Rated peak withstand current (Ipk) up to 220 KA
- Rated short-time withstand current (Icw) up to 80 KA-1sec

Insulation characteristics

- Clearence >20 mm
- Creepage distance >20 mm
- Pollution degree 3

Degree of protection

- According to IEC 60529 :
 - IP 54/IP 55 for switchboards & IP-65 for non compartmentalized distribution Boards. CPRI & ERDA TESTED

Gasketing

- Joint-less, seamless self adhesive, PU foam Gasketing to ensure defined IP.

Enclosure

- Modular design, uses CR Grade CRCA and Electro galvanized steel for structures are SKIN Pass, Zero spangle with high GSM zinc coating. Ensuring high corrosion resistance against extreme climatic condition after powder coating.

Mechanical Impact

- According to IEC 62262 : 2002 IK-10 followed by IP 55; ERDA tested

Forms of seperation

- According to IEC 61439-2 Up to Form 4 Type 6

Structure components

- Sheet steel of frame & load bearing member 2.0mm/GI
- Door partition & Cover with stiffner Upto 2mm
- Gland plate Upto 3mm
- Base frame channel ISMC 75/100 or 3mm CRCA

Surface treatment / Painting

- Frame including internal subdivisions & external Standard paint shade - RAL-7035, RAL-7032 and 631 as per IS:5. Ten tank spray type pre-treatment prior to powder coating with fully automated powder coating shop.

Plastic components

- Flame retardant, halogen free flame retardant, halogen free

Resistance to corrosion

- Salt spray test - Tri Cataionic Zinc Phosphate based powder coated enclosure can withstand 1000 Hrs in SST as per IS

Bus bar systems

- Bus bar insulation
 - Main Bus bars & vertical bus bars are fully sleeved with insulated heat shrunk PVC Sleeves except at the joints for electrical insulation.
- Bus bar support
 - All bus bars are supported with rigid SMS/DMC supports & are shrouded with FRP from rear side.

3Phase Automatic Power Factor Correction (APFC) Panels

Key Features

- Advanced Micro Controller based Power Factor Controller with Self-diagnostic Sensing and Control of Capacitor Bank Stages.
- High performance 'BCH' Cylindrical & Box type Capacitors.
- Capacitor duty Contactors for reliable & trouble free operation.
- Choice of BCH Make Thyristor switch for capacitor switching & CU/AL wound Detuned reactor as an option.
- Choice of selection of Capacitors as per application & site conditions.
- Thoughtfully designed Panels with provision for louvres & cooling fan for proper ventilation to manage heat load.
- Enclosure with Epoxy based paint shade RAL 7035
- PU Foam Gasketing for sustained Ingress Protection of the Panel.



Five Standard Versions of APFC Panels are available depending upon Switching Sequence, Mode of Control (Automatic & Manual options) & Type of Capacitors (Cylindrical / Box type) used.

VERSION 1 - With BCH MPP Heavy Duty Cylindrical Capacitors & **WITHOUT** Manual option.

VERSION 2 - With BCH MPP Heavy Duty Box Capacitors & **WITHOUT** Manual option.

VERSION 3 - With BCH MPP Heavy Duty Cylindrical Capacitors & **WITH** Manual option.

VERSION 4 - With BCH MPP Heavy Duty Box Capacitors & **WITH** Manual option.

VERSION 5 - With BCH APP Box Type Capacitors & **WITH** Manual option.

(Other tailor made versions on request)

Common Features

CAPACITOR RATING - 40 to 200KVA in Standard Ratings of 40, 50, 60, 75, 100, 125, 150, 175 & 200 KVA with suitable banking arrangement.

MOUNTING - Wall Mounting up-to 75KVA & Floor Mounting above 75 KVA ratings.

INCOMING - BCH-Resilient 3-P MCCB with Rotary handle.

OUTGOING - TP MCB or HRC fuses with fuse base as standard (BCH-Resilient 3-P MCCB or SDFU and Compartmentalized outgoing feeders can also be provided depending upon size of panel on request).

CONTACTORS - BCH Capacitor Duty Contactors as standard (BCH Thyristor switches on request).

R-Y-B INDICATIONS - RYB for Incomer & ON-OFF for Outgoing

AMMETER/VOLTMERS - Provided for VERSIONS 3, 4 & 5 only.

For prices contact our nearest sales office.

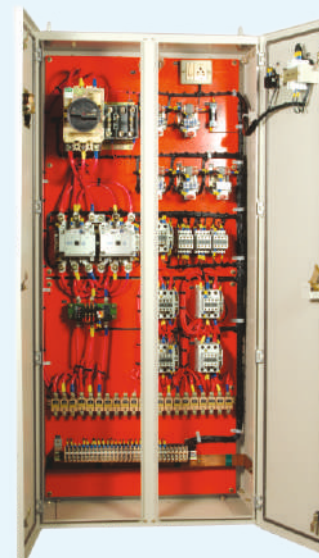



AC Crane Control Bridge and Trolley Motion

This controller provides reversing and plugging operation of slip ring induction motors in heavy duty cranes on Trolley services. Upto 5 motor speeds are achieved in conjunction with a master controller.



Design Features

- Simplified reliable circuitary
- Inverse Time delay Magnetic Overload protection
- Time Limit acceleration
- Speed Control by series resistors
- No Volt protection
- Special Unique plugging circuit with a voltage relay
- CRCA Sheet steel construction of the panel.
- 7 Tank pretreated panels for extremely long life
- Panels for indoor and outdoor protection



AC Crane Control Hoisting Motion

- Plain rotor resistance
- AC Single phase dynamic braking
- Counter torque lowering
- Oprotor Control
- Creep Speed

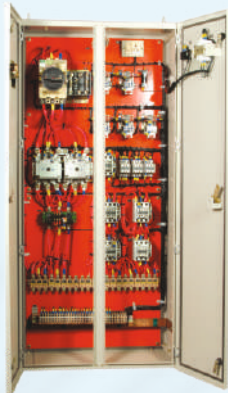

DC Crane Control Hoisting Motion

This control is for use with series wound motors drive for crane hoists and is arranged for reversing and dynamic lowering service. control



DC Crane Control (Bridge and Trolley motion)

This controller provides reversing and plugging operation of series wound motors in heavy duty cranes on Trolley services. Upto 5 motor speeds are achieved in conjunction with a master controller.

Design Features

- Simplified reliable circuitary
- Inductive time limit acceleration on hoisting & lowering
- Better speed control on light or heavy loads when hoisting or lowering
- CRCA Sheet steel construction of the panel.
- 7 Tank pretreated panels for extremely long life

Design Features

- Simplified, reliable circuitary
- Rectifier controlled plugging
- Instantaneous and Inverse time delay magnetic overload protection
- No volt protection
- Heavy duty DC Contactors equipped with magnetic blowouts
- CRCA Sheet steel construction of the panel.
- 7 Tank pretreated panels for extremely long life

Power Receptacles

Range

- Single / Multiple outlet boxes
- 16/32/63/125A rating
- With or without protection
- Option of back up protection with :
MCBs
SDFUs
MCCBs
- Modular and compact construction
- Loop in Loop out facility
- Higher degree of Ingress Protection
- 7 Tank processed powder coated enclosure
- PU Gasketing for excellent sealing against dust and water

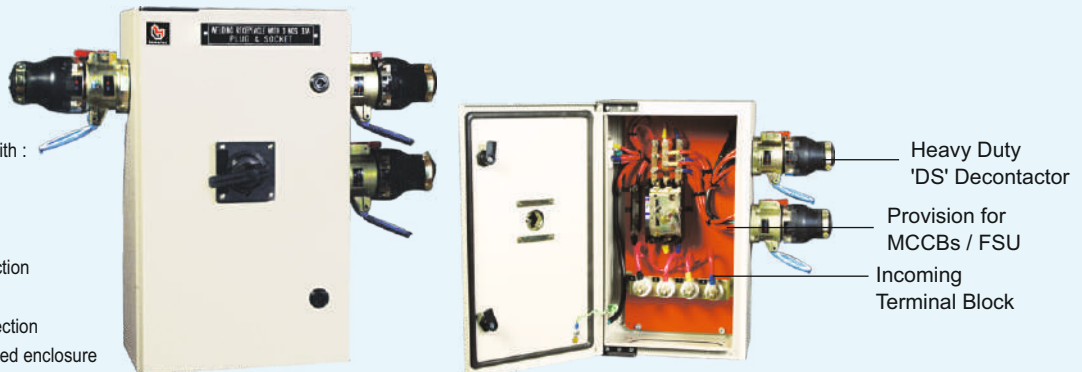

Plugs and Socket outlets with / without protection, mounted in CRCA enclosure of suitable size

Single Outlet	Incomer (1 No.)			Standard Version Cat reference	Loop in loop out version Cat reference
	Switch Type	MCCB Type	MCB		
1 No DS1A7A1 and 1 No. DS1B7A1	PSFS323ND000/ PSFS323ND00	-	-	PR16SDF-1	PR16SDF-1-LILO
1 No DS1A7A1 and 1 No. DS1B7A1	-	-	16A,TPN	PR16MCB-1	PR16MCB-1-LILO
1 No DS1A7A1 and 1 No. DS1B7A1	-	-	-	PR16WP-1	PR16WP-1-LILO
1 No DS3A7A1 and 1 No. DS3B7A1	PSFS323ND000/ PSFS323ND00	-	-	PR32SDF-1	PR32SDF-1-LILO
1 No DS3A7A1 and 1 No. DS3B7A1	-	-	32A,TPN	PR32MCB-1	PR32MCB-1-LILO
1 No DS3A7A1 and 1 No. DS3B7A1	-	-	-	PR32WP-1	PR32WP-1-LILO
1 No DS6A7A1 and 1 No. DS6B7A1	PSFS633ND000/ PSFS633ND00	-	-	PR63SDF-1	PR63SDF-1-LILO
1 No DS6A7A1 and 1 No. DS6B7A1	-	XFE063N+ separate Neutral Link + Rotary Handle	-	PR63MCCB-1	PR63MCCB-1-LILO
1 No DS6A7A1 and 1 No. DS6B7A1	-	-	63A,TPN	PR63MCB-1	PR63MCB-1-LILO
1 No DS6A7A1 and 1 No. DS6B7A1	-	-	-	PR63WP-1	PR63WP-1-LILO
1 No DS9A7A1 and 1 No. DS9B7A1	PSFS1253ND	-	-	PR125SDF-1	PR125SDF-1-LILO
1 No DS9A7A1 and 1 No. DS9B7A1	-	XF2H125NV+ separate Neutral Link + Rotary Handle	-	PR125MCCB-1	PR125MCCB-1-LILO
1 No DS9A7A1 and 1 No. DS9B7A1	-	-	-	PR125WP-1	PR125WP-1-LILO

Double Outlet

2 No DS6A7A1 and 2 No. DS6B7A1	-	XF2H125NV+ separate Neutral Link + Rotary Handle	-	PR63MCCB-2	PR63MCCB-2-LILO
2 No DS6A7A1 and 2 No. DS6B7A1	PSFS1253ND	-	-	PR63SDF-2	PR63SDF-2-LILO

* Prices : Available on request

Auto Transformer Starter Panels upto 800 HP

Advantages

Good Starting Torque and current performance
 Possibility of adjusting starting parameters
 No break in supply to the motor during starting
 Best suited when maximum reduction of Inrush current is desired or motor requires longer acceleration time with Good starting torque

- Blowers ■ Compressors ■ Crushers
- Pumps ■ Extruders

Range & Specifications

- Available upto 800HP
- Standard Tappings : 50% , 65% and 80%
- Air Cooled design & Oil cooled
- 7 Tank pre treated bolted construction enclosure
- Superior gasket

Protections

- Short Circuit
- Overload and Single Phasing (Thru Overload relay)
- Under voltage
- Other protections available on request

Metering and indication

- Voltmeter with selector switch
- Ammeter with selector switch
- R, Y, B phase indication
- Motor ON, OFF and Trip indication



HSN Code - 8537

BIL Auto Transformer Starter - STANDARD RATINGS	MODEL 1 - BASICATS : PU door-gasket Enclosure, 3nos. Power Contactor, Citation OLR, Start/Stop PB, Motor ON LED		MODEL 2 - PREMIUM Version : PU door- gasket Enclosure, MCCB Incomer, 3nos. Power Contactor, Citation OLR, Electronic SPP, Ammeter/voltmeter with selector switches, Start/Stop PB, Phase & Motor ON/Trip LEDs.	
	HP	Cat. code for Air cooled	Cat. code for Oil cooled	Cat. code for Air cooled
20	ATEA20	ATEO20	ATPA20	ATPO20
25	ATEA25	ATEO25	ATPA25	ATPO25
30	ATEA30	ATEO30	ATPA30	ATPO30
35	ATEA40	ATEO40	ATPA40	ATPO40
40	ATEA40	ATEO40	ATPA40	ATPO40
50	ATEA50	ATEO50	ATPA50	ATPO50
60	ATEA60	ATEO60	ATPA60	ATPO60
75	ATEA75	ATEO75	ATPA75	ATPO75
100	ATEA100	ATEO100	ATPA100	ATPO100
125	ATEA125	ATEO125	ATPA125	ATPO125
150	ATEA150	ATEO150	ATPA150	ATPO150
175	ATEA175	ATEO175	ATPA175	ATPO175
200	ATEA200	ATEO200	ATPA200	ATPO200
225	ATEA225	ATEO225	ATPA225	ATPO225
250	ATEA250	ATEO250	ATPA250	ATPO250
300	ATEA300	ATEO300	ATPA300	ATPO300
350	ATEA350	ATEO350	ATPA350	ATPO350
400	ATEA400	ATEO400	ATPA400	ATPO400

* Contact nearest sales office for Prices



BCH

Price List

General Terms & Conditions

Prices are subject to change without any prior notice and will be applicable as prevailing at the time of dispatch.

- The prices are ex-works basis..
- The prices given in this list are effective as on date and are subject to change without notice.
- Maximum Retail Price (MRP) mentioned are inclusive of GST.
- The List Prices (LP) mentioned are exclusive of GST.
- The duties, taxes and other statutory levies are based on rates prevailing at the time of billing. Any subsequent revision of those rates having retrospective effective shall be to customer's account.
- In case where any GST exemption has been claimed, the purchaser is responsible for providing the necessary GST exemption form within the specified period, failing which the purchaser would be liable for the payment of full GST plus applicable interest and penalties
- All Prices are in Indian Rupees (₹).
- Alteration made after receipt of confirmation of order are subject to price & delivery revisions and any other expenses or levies
- The dispute, if any, will be resolved mutually by discussion. However, if no settlement is forthcoming then, the Courts at New Delhi shall only have territorial jurisdiction to hear and decide the dispute.

Warranty

Other range of BCH Products :

These products are warranted, against manufacturing defects for a period of 18* months from the date of invoicing & 24 months from date of manufacturing whichever is later subject to the provision of proper usage and does not cover defects arising out of fire, accident, inefficient maintenance, faulty operation and willful or accidental damage. The manufacturer shall not be liable for any consequential loss, injury or damages attributable to defect or failure of its products.

BCH Products Ultra Power ACBs, Mega Power ACBs, MCCBs-XA,XB,XG range, X-Line SDF & BCH4-4P Contactors:

These products are warranted, against manufacturing defects for a period of 18* months from the date of invoice, subject to the provision of proper usage and does not cover defects arising out of fire, accident, inefficient maintenance, faulty operation and willful or accidental damage. It also does not covers damage to power electronic components caused predominantly due to higher temperature or over voltages. The manufacturer shall not be liable for any consequential loss, injury or damages attributable to defect or failure of its products.

* Proof of purchase to be retained to avail warranty.



a strong commitment
to serve better
always ...



**Switchgear | Controlgear | Enclosures | Motor Starters & Submersible Pump Starters |
Brakes and Crane Controls | MCC | PCC | Customised Solutions | Automation |
Wires & Cables | Motors | Reactive Power Management**



**BCH
ELECTRIC
LIMITED**

www.bchindia.com

Power Control Products

Starters & Submersible Pump Starters

Industrial Enclosures

Industrial Products

Wires & Cables

Motor Control Products

Power Bus Duct

Customised Solution

Automation

a strong commitment to serve better always ...



BCH

BCH
ELECTRIC
LIMITED



1800-103-9262

customer care@bchindia.com

Visit us at : www.bchindia.com

Registered & Corporate Office : 1105, New Delhi House, 27, Barakhamba Road, New Delhi - 110 001 Tel. : 91-11- 43673100

CIN : U31103DL1965PLC425953, Customer care No. 1800-103-9262, E-mail : marketing@bchindia.com

Works 1 : 20/4, Mathura Road, Faridabad - 121 006 (Haryana) Tel. : 0129-4063000/4293000 Fax : 0129-2304016

Works 2 : 64-68, Sector-7, IIE, Pant Nagar, Rudrapur, Udham Singh Nagar - 263 153 (Uttarakhand) Tel. : 05944-250214/16 Fax : 05944-250215

Sales Offices :

Ahmedabad
401, Shilp Zeveri,
Beside Shyamal Iconic,
Above Westside,
Shyamal Cross Road,
Ahmedabad - 380015
E-mail : ahmedabad@bchindia.com

Bangalore
2nd Floor, 130/5,
K.H. Road (Double road),
Bangalore - 560 027
Tel. : 080-41144879 / 22236759
E-mail : bangalore@bchindia.com

Bhubaneswar
Mallick Commercial
Complex Plot No.: A/69, unit - 3
Bhubaneswar - 751 001
Tel. : 0674-2380988
E-mail : bhubaneswar@bchindia.com

Chandigarh (Panchkula)
SCO -270, 2nd Floor,
Sector-16, Panchkula
Haryana-134 113
Tel. : 0172-5078957 / 5049905
E-mail : chandigarh@bchindia.com

Chennai
Flat No. 3A, 3rd Floor,
Sree Apartments,
No.508, TTK Road,
Alwarpet, Chennai 600 018
Tel. : 044-24337046, 24337047
E-mail : chennai@bchindia.com

Coimbatore
87, Dr. Nanjappa Road,
Coimbatore - 641 018
Tel. : 0422-2305311 / 2302599
E-mail : coimbatore@bchindia.com

Delhi 1
801, Akash Deep Building,
26A, Barakhamba Road,
New Delhi - 110 001
Tel. : 011-23313878 / 43518200
E-mail : delhi1@bchindia.com

Delhi 2
710, Deepali Building, 92
Nehru Place, New Delhi - 110
019 Tel. : 011-45720334
E-mail : delhi2@bchindia.com

Dehradun
8, Co-operative Industrial Estate,
Patel Nagar, Dehradun-248001
E-mail : dehradun@bchindia.com

Faridabad
20/4, Mathura Road,
Faridabad - 121 006 (Haryana)
Tel. : 0129-4293009
E-mail : faridabad@bchindia.com

Hyderabad
1-8-303/48/13/102, Arya One,
2nd Floor, P. G. Road,
Secunderabad - 500 003
Tel. : 040-68206263/27890306
Fax : 040-68207273
E-mail : hyderabad@bchindia.com

Indore
330-331, Indraprastha Tower,
3rd Floor, 6, M.G. Road,
Indore - 452 001
Tel. : 0731-2510011 / 2510012
E-mail : indore@bchindia.com

Jaipur
25, Hathroi, Gopalbari,
Jaipur - 302 001
Tel. : 0141-2363521
E-mail : jaipur@bchindia.com

Jamshedpur
A.J. Tower, 2B,
2nd Floor, R-Road, Bistupur,
Jamshedpur - 831 001
E-mail : jamshedpur@bchindia.com

Kolkata
Block 1E, 216,
Acharya Jagadish Chandra Bose
Road, Kolkata - 700 017
Tel. : 033-22871728 / 46021884
E-mail : kolkata@bchindia.com

Lucknow
Shop No. 3, First Floor,
Tower T-10, Millennium Place IBB - 2,
Sushant Golf City, Sultanpur Road,
Lucknow U.P. - 226030
Tel. : 0522-4025597/4025997
E-mail : lucknow@bchindia.com

Ludhiana
S.C.O.-18, 2nd Floor,
Feroze Gandhi Market,
Ludhiana - 140 001
Tel. : 0161-5021807/5022808
E-mail : ludhiana@bchindia.com

Madurai
12, Parvathi Plaza-3rd Floor,
70 Feet Road, Ellis Nagar
Madurai-625016, Tamilnadu
Email: madurai@bchindia.com

Mumbai
A-151, Mittal Tower,
Nanman Point,
Mumbai - 400 021
Tel. : 022-22822947/22850162
Fax : 022-22822858
E-mail : mumbai@bchindia.com

Patna
No.703, 7th Floor, Luv Kush
Tower, Exhibition Road,
Patna - 800001

Pune
8, Sarosh Bhavan,
16-B/1, Dr. Ambedkar Road,
Pune - 411 001
Tel. : 020-41210002
E-mail : pune@bchindia.com

Raipur
6th Floor, Office No. 607,
Babylon Capital, Near Oswal
Petrol Pump, VIP Chowk,
G.E. Road, Raipur - 492 006
Tel. : 0771-4045053
E-mail : raipur@bchindia.com

Vadodara
301, Third Floor, "Florence Classic",
10, Ashapuri Co-Op. Hsg. Soc. Ltd., Opp. VUDA
Housing, Near Cow Circle, Akota, Vadodara - 390 020
Tel. : 0265-2345068/2345069
Telefax : 0265-2345068,
E-mail : vadodara@bchindia.com

Other Branch Locations

Cochin : cochin@bchindia.com, Guwahati : guwahati@bchindia.com, Vishakapatnam : vizag@bchindia.com, Surat : surat@bchindia.com, Trichy : Trichy@bchindia.com

Resident Engineer Locations

Agra	Bhopal	Hospet	Kanpur	Muzaffarnagar	Rajahmundry	Silliguri	Varanasi
Ahmednagar	Calicut	Hubli	Karimnagar	Nanded	Ranchi	Solapur	Vijaywada
Ambala	Goa	Idukki	Karnal	Nashik	Rourkela	Srinagar	Vishakapatnam
Anantapur	Gulbarga	Jabalpur	Kota	Panipat	Rudarpur	Trivendrum	Vellore
Ankleshwar	Gurgaon	Jalandhar	Kurnool	Patna	Salem	Tirunelveli	Vilupuram
Aurangabad	Haridwar	Jodhpur	Midnapore	Puducherry	Sikar	Udaipur	Warangal
Bhiwadi	Hisar	Kashipur	Mahua	Rajkot	Silchar	Vapi	Yamunanagar

Since product improvement is a continuous process, the data furnished in this brochure may undergo revision without prior notice.



BCH

BCH
ELECTRIC
LIMITED

FINAL DISTRIBUTION PRODUCTS

Price List effective 17th November 2025

Modern facilities at Faridabad & Rudrapur



Our Strengths

- ◆ State-of-the-art product development and R&D
- ◆ Modern manufacturing facilities
- ◆ Tool room with latest facilities
- ◆ Serving customers for five decades
- ◆ Presence in ~50 locations
- ◆ 650 channel partners
- ◆ ISO 9001:2015 & ISO 14001:2015, ISO 45001: 2018 certified company

Core Values

- ◆ Integrity
- ◆ Nurturing People
- ◆ Commitment to Customers
- ◆ Striving for Excellence
- ◆ Long Term Thinking

Quality Policy

We as a member of BCH Electric Limited manufacturer of Low Voltage Switchgear & Controlgear products, are fully committed to provide Quality products and service in compliance with applicable Statutory and Regulatory requirements, to meet or exceed the customer need and expectations through -

- ◆ Continual improvement
- ◆ Involvement of employees
- ◆ Setting Quality objectives
- ◆ Training and development of employees

Health & Safety Policy

We as a member of BCH Electric Limited manufacturer of Low Voltage Switchgear & Controlgear products, are fully committed to conduct Business in compliance to applicable Health & Safety legislation and regulation.

We shall continually improve through -

- ◆ Provide Safe & Healthy working conditions for the prevention of work related injury and ill health.
- ◆ Develop & maintain the Health & Safety objectives & targets and conduct health & safety programs for achieving the objectives and target.
- ◆ The prevention of accidents through the identification, assessment and elimination of workplace hazards and the promotion of health & safety awareness among its employees and contractors.
- ◆ Encourage employee's participation and consultation in matters affecting the health, safety and well being of our people and seek suggestions from our employees of ways in which health, safety & well being can be furthered.

The Health & safety policy is publicly available on request.

Environmental Policy

We as a member of BCH Electric Limited manufacturer of Low Voltage Switchgear & Controlgear products, are fully committed to conduct Business in compliance to applicable Environmental legislation and regulation.

We shall continually improve through -

- ◆ Provide a framework for setting and reviewing environmental objectives and targets.
- ◆ Regularly review the impact of our activities on environment and strive to reduce the pollution/waste.
- ◆ Involve employees in our environmental program and provide necessary training to enable them to discharge their responsibilities towards environment management.
- ◆ Sustain the program of continual improvement in environment in environmental performance incorporating suitable metrics and monitoring.

The Environment policy is publicly available on request.

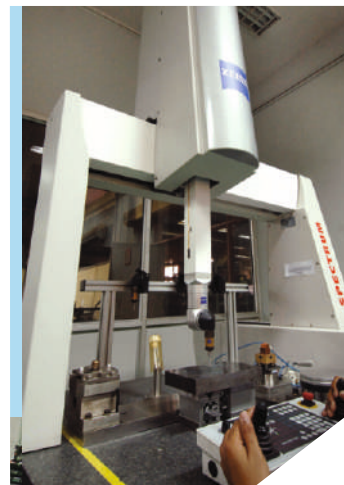

www.bchindia.com

Miniature Circuit Breaker

Product Range

- Current ratings : 0.5A - 63A
- Possible configuration : 1P / 1P+N / 2P / 3P / 3P+N / 4P
- Insulation voltage : 690V
- Impulse withstand : 4kV
- Breaking capacity : 10kA
- Terminal capacity : 35 Sq mm (Cu)
- Magnetic tripping curve : B Curve & C Curve
- Compliance with standards : IS/IEC 60898-1
IS/IEC 60947-2
- Operating temperature range : -5°C to +55°C
- Electrical life : Up to 10000 operations
(IS recommend & certifies 4000 operations)
- Mechanical life : Up to 10000 operations
- Energy Limiting Class : 3

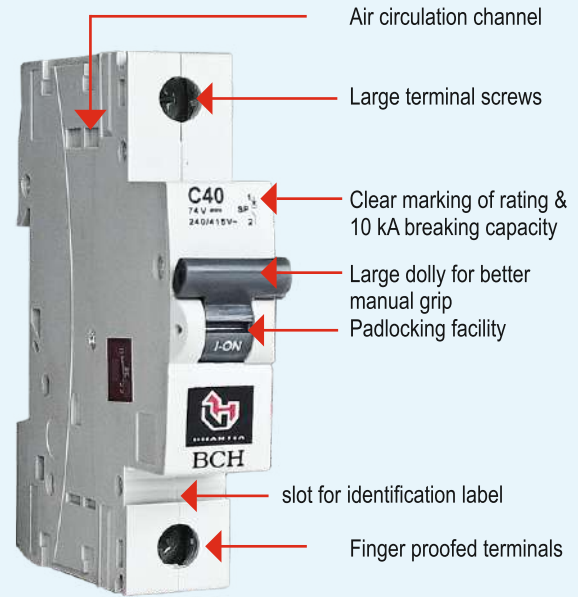

Salient Features

- Line load interchangeability
- Dual Position Mounting Clip for easy installation
- Fast Tripping
- Current limiting design
- 45mm panel cutout, suitable for standard MCB distribution boards
- Possibility of busbar termination at both ends

PRODUCT CERTIFICATION

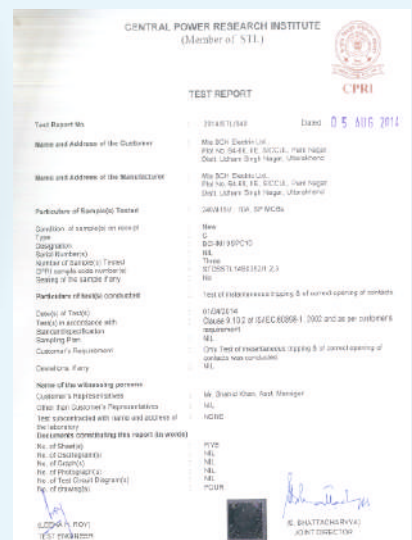

Tripping Curves

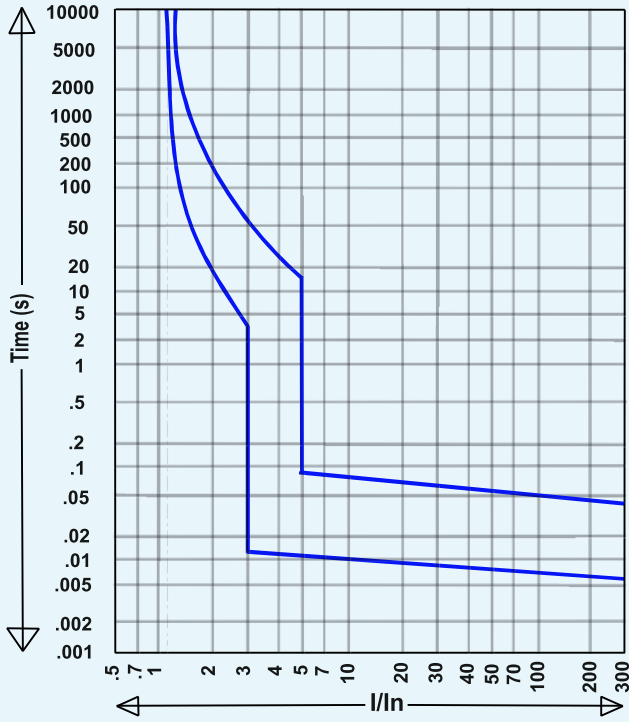

'B' Characteristics

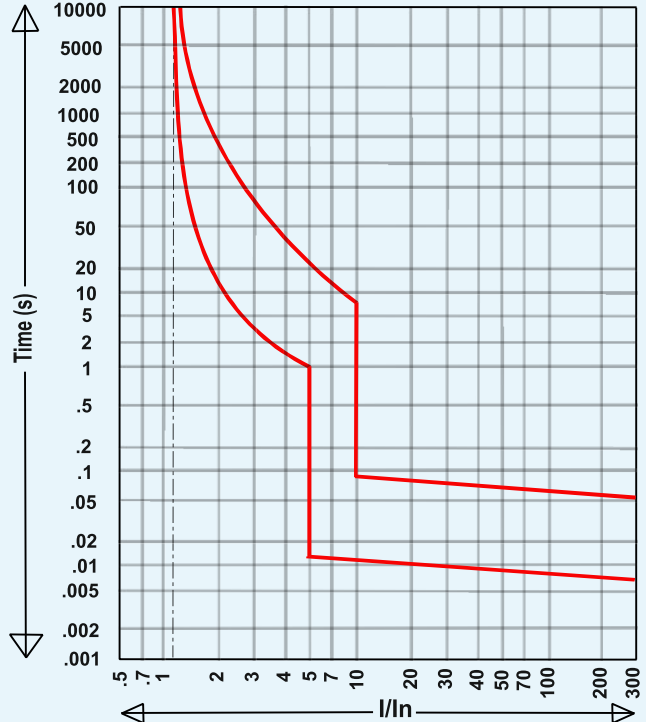

'C' Characteristics

Low Watt Loss to Save Energy

Comparison w.r.t. IS/IEC - 60898 -1-2002		
Rating (Amp)	As per IS/IEC 60898-1-2002 Maximum Watt Loss	BCH Watt Loss / pole (Watt)
6	3.0W	1.4
10	3.0W	1.95
16	3.5W	2.19
20	4.5W	2.4
25	4.5W	2.9
32	6.0W	4.5
40	7.5W	5
50	7.5W	5.5
63	13.W	6.93



Pole	Standard pack of	Rating	B Curve Cat. No.	MRP [₹]	C Curve Cat. No.	MRP (per unit)[₹]	Rating	Lower Rating Cat. No.	MRP (per unit)[₹]
1P	12 units	6A	BCHX10SPB06	285	BCHX10SPC06	285	0.5A 1A 2A 3A 4A 5A	BCHX10SPCL5	500
		10A	BCHX10SPB10	285	BCHX10SPC10	285		BCHX10SPC01	500
		16A	BCHX10SPB16	285	BCHX10SPC16	285		BCHX10SPC02	500
		20A	BCHX10SPB20	285	BCHX10SPC20	285		BCHX10SPC03	500
		25A	BCHX10SPB25	285	BCHX10SPC25	285		BCHX10SPC04	500
		32A	BCHX10SPB32	285	BCHX10SPC32	285		BCHX10SPC05	500
		40A	BCHX10SPB40	695	BCHX10SPC40	695			
		50A	BCHX10SPB50	695	BCHX10SPC50	695			
1P+N	6 units	6A			BCHX10SNC06	1000			
		10A			BCHX10SNC10	1000			
		16A			BCHX10SNC16	1000			
		20A			BCHX10SNC20	1000			
		25A			BCHX10SNC25	1000			
		32A			BCHX10SNC32	1000			
		40A			BCHX10SNC40	1490			
		50A			BCHX10SNC50	1490			
2P	6 units	6A	BCHX10DPB06	1055	BCHX10DPC06	1055	0.5A 1A 2A 3A 4A 5A	BCHX10DPCL5	1485
		10A	BCHX10DPB10	1055	BCHX10DPC10	1055		BCHX10DPC01	1485
		16A	BCHX10DPB16	1055	BCHX10DPC16	1055		BCHX10DPC02	1485
		20A	BCHX10DPB20	1055	BCHX10DPC20	1055		BCHX10DPC03	1485
		25A	BCHX10DPB25	1055	BCHX10DPC25	1055		BCHX10DPC04	1485
		32A	BCHX10DPB32	1055	BCHX10DPC32	1055		BCHX10DPC05	1485
		40A	BCHX10DPB40	1640	BCHX10DPC40	1640			
		50A	BCHX10DPB50	1640	BCHX10DPC50	1640			
3P	4 units	6A	BCHX10TPB06	1660	BCHX10TPC06	1660	0.5A 1A 2A 3A 4A 5A	BCHX10TPCL5	2030
		10A	BCHX10TPB10	1660	BCHX10TPC10	1660		BCHX10TPC01	2030
		16A	BCHX10TPB16	1660	BCHX10TPC16	1660		BCHX10TPC02	2030
		20A	BCHX10TPB20	1660	BCHX10TPC20	1660		BCHX10TPC03	2030
		25A	BCHX10TPB25	1660	BCHX10TPC25	1660		BCHX10TPC04	2030
		32A	BCHX10TPB32	1660	BCHX10TPC32	1660		BCHX10TPC05	2030
		40A	BCHX10TPB40	2520	BCHX10TPC40	2520			
		50A	BCHX10TPB50	2520	BCHX10TPC50	2520			
3P+N	3 units	6A			BCHX10TNC06	2135			
		10A			BCHX10TNC10	2135			
		16A			BCHX10TNC16	2135			
		20A			BCHX10TNC20	2135			
		25A			BCHX10TNC25	2135			
		32A			BCHX10TNC32	2135			
		40A			BCHX10TNC40	2890			
		50A			BCHX10TNC50	2890			
4P	3 units	6A	BCHX10FPB06	2230	BCHX10FPC06	2230	0.5A 1A 2A 3A 4A 5A	BCHX10FPCL5	2785
		10A	BCHX10FPB10	2230	BCHX10FPC10	2230		BCHX10FPC01	2785
		16A	BCHX10FPB16	2230	BCHX10FPC16	2230		BCHX10FPC02	2785
		20A	BCHX10FPB20	2230	BCHX10FPC20	2230		BCHX10FPC03	2785
		25A	BCHX10FPB25	2230	BCHX10FPC25	2230		BCHX10FPC04	2785
		32A	BCHX10FPB32	2230	BCHX10FPC32	2230		BCHX10FPC05	2785
		40A	BCHX10FPB40	3175	BCHX10FPC40	3175			
		50A	BCHX10FPB50	3175	BCHX10FPC50	3175			
	63A	BCHX10FPB63	3250	BCHX10FPC63	3250				



HSN Code : 8536

Poles	Standard Pack of	Rating	Cat. No.	MRP (per unit) [₹]
2P	6 units	40A	BCHISODP40	715
	6 units	63A	BCHISODP63	880
3P	4 units	40A	BCHISOTP40	1270
	4 units	63A	BCHISOTP63	1455
4P	3 units	40A	BCHISOFP40	1490
	3 units	63A	BCHISOFP63	1615

MCB DISTRIBUTION BOXES



HSN Code : 8537



No. Of Way	No. of Modules (Incoming + Outgoing)	Cat. No. (Single Door)	MRP [₹]
4 WAY	4	BCHPSPNSD04W	1435
6 WAY	6	BCHPSPNSD06W	1535
8 WAY	8	BCHPSPNSD08W	1800
12 WAY	12	BCHPSPNSD12W	2355
16 WAY	16	BCHPSPNSD16W	3015

No. Of Way	Cat. No. (Double Door)	MRP [₹]
4 WAY	BCHPSPNDD04W	2310
6 WAY	BCHPSPNDD06W	2360
8 WAY	BCHPSPNDD08W	2710
12 WAY	BCHPSPNDD12W	3630
16 WAY	BCHPSPNDD16W	4635



No. Of Way	No. of Modules (Incoming + Outgoing)	Cat. No. (Single Door)	MRP [₹]
4 WAY	4	BCHPHTPNSD04W	4655
6 WAY	6	BCHPHTPNSD06W	5585
8 WAY	8	BCHPHTPNSD08W	6145

No. Of Way	Cat. No. (Double Door)	MRP [₹]
4 WAY	BCHPHTPNDD04W	5835
6 WAY	BCHPHTPNDD06W	7255
8 WAY	BCHPHTPNDD08W	9010

HSN Code : 8537



Description	No. of Modules (Incoming + Outgoing)	Cat. No. (Single Door)	MRP [₹]	Cat. No. (Double Door)	MRP [₹]
4 WAY, SPN DB	4	BCHSPNSD04W	1460	BCHSPNDD04W	2375
6 WAY, SPN DB	6	BCHSPNSD06W	1555	BCHSPNDD06W	2430
8 WAY, SPN DB	8	BCHSPNSD08W	1825	BCHSPNDD08W	2785
12 WAY, SPN DB	12	BCHSPNSD12W	2395	BCHSPNDD12W	3725
16 WAY, SPN DB	16	BCHSPNSD16W	3055	BCHSPNDD16W	4760

HSN Code : 8537



Description	No. of Modules (Incoming + Outgoing)	Cat. No. (Single Door)	MRP [₹]	Cat. No. (Double Door)	MRP [₹]
4 WAY, HTPN DB	8+12	BCHHTPNSD04W	4785	BCHHTPNDD04W	5995
6 WAY, HTPN DB	8+18	BCHHTPNSD06W	5740	BCHHTPNDD06W	7455
8 WAY, HTPN DB	8+24	BCHHTPNSD08W	6315	BCHHTPNDD08W	9260
12 WAY, HTPN DB	8+36	BCHHTPNSD12W	8375	BCHHTPNDD12W	13245



HSN Code : 8537

Description	Cat. No.	No. of Modules (Incoming + Outgoing)	MRP [₹]
4 WAY, DD, MCB I/C, VERTICAL TPN DB	BCHVTPNDD04W-A	8+12	12990
6 WAY, DD, MCB I/C, VERTICAL TPN DB	BCHVTPNDD06W-A	8+18	16260
8 WAY, DD, MCB I/C, VERTICAL TPN DB	BCHVTPNDD08W-A	8+24	18315
12 WAY, DD, MCB I/C, VERTICAL TPN DB	BCHVTPNDD12W-A	8+36	23400

All above DB's are double door



HSN Code : 8537

Description	Cat. No.	Suitable for MCCB Frame	MRP [₹]
4 WAY, DD, 125A, 3P MCCB I/C VERTICAL TPN DB	BCHVTPNDD04W-B	FRAME 1	17700
8 WAY, DD, 125A, 3P MCCB I/C VERTICAL TPN DB	BCHVTPNDD08W-B	FRAME 1	20285
12 WAY, DD, 125A, 3P MCCB I/C VERTICAL TPN DB	BCHVTPNDD12W-B	FRAME 1	27475
4 WAY, DD, 250A, 3P MCCB I/C VERTICAL TPN DB	BCHVTPNDD04W-C	FRAME 2	21565
8 WAY, DD, 250A, 3P MCCB I/C VERTICAL TPN DB	BCHVTPNDD08W-C	FRAME 2	26350
12 WAY, DD, 250A, 3P MCCB I/C VERTICAL TPN DB	BCHVTPNDD12W-C	FRAME 2	30765

All above DB's are double door



HSN Code : 8537

Description	Cat. No.	Suitable for MCCB Frame	MRP [₹]
4 WAY, DD 125A 4P MCCB I/C, VERTICAL TPN DB	BCHVTPNDD04W-XA1B0	XA1/XB0/XD0	18590
8 WAY, DD, 125A, 4P MCCB I/C, VERTICAL TPN DB	BCHVTPNDD08W-XA1B0	XA1/XB0/XD0	21300
12 WAY, DD, 125A, 4P MCCB I/C, VERTICAL TPN DB	BCHVTPNDD12W-XA1B0	XA1/XB0/XD0	28850



HSN Code : 8537

Description	Cat. No.	No. of Modules (Incoming + Outgoing)	MRP [₹]
4 WAY, DD, 7 SEGMENT PHASE SEGREGATED DB	BCHPHSGDD04W	8+12+12	19455
6 WAY, DD, 7 SEGMENT PHASE SEGREGATED DB	BCHPHSGDD06W	8+12+18	21915
8 WAY, DD, 7 SEGMENT PHASE SEGREGATED DB	BCHPHSGDD08W	8+12+24	24475
12 WAY, DD, 7 SEGMENT PHASE SEGREGATED DB	BCHPHSGDD12W	8+12+36	31095

All above DB's are double door



HSN Code : 8537

Description	Cat. No.	No. of Modules (Incoming + Outgoing)	MRP [₹]
4 WAY, 40A, DD, PHASE SELECTOR DB	BCHPHSLDD04W-40		20010
6 WAY, 40A, DD, PHASE SELECTOR DB	BCHPHSLDD06W-40		20545
8 WAY, 40A, DD, PHASE SELECTOR DB	BCHPHSLDD08W-40		23005
12 WAY, 40A, DD, PHASE SELECTOR DB	BCHPHSLDD12W-40		26215
4 WAY, 63A, DD, PHASE SELECTOR DB	BCHPHSLDD04W-63		20170
6 WAY, 63A, DD, PHASE SELECTOR DB	BCHPHSLDD06W-63		20865
8 WAY, 63A, DD, PHASE SELECTOR DB	BCHPHSLDD08W-63		23970
12 WAY, 63A, DD, PHASE SELECTOR DB	BCHPHSLDD12W-63		26645

All above DB's are double door



HSN Code : 8537

Description	Cat. No.	No. of Modules (Incoming + Outgoing)	MRP [₹]
2 ROW, 13 MODULE, DD, ROW DB	BCHROWDB2R13	13	8895
3 ROW, 13 MODULE, DD, ROW DB	BCHROWDB3R13	13	10480
4 ROW, 13 MODULE, DD, ROW DB	BCHROWDB4R13	13	11610

All above DB's are double door

★ All above DB's are Non Stockable with leadtime of 45 days



HSN Code : 8537

Description	Cat. No.	No. of Modules (Incoming + Outgoing)	MRP [₹]
SPN-10A, P&S DB	BCHPSDBSPN10		1800
SPN-20A, P&S DB	BCHPSDBSPN20		1800
TPN-20A, P&S DB	BCHPSDBTPN20		5150
TPN-30A, P&S DB	BCHPSDBTPN30		5150



HSN Code : 8537

Description	Cat. No.	No. of Modules (Incoming + Outgoing)	MRP [₹]
SP, ONE WAY MCB DB	BCHOWMCBDBSP		745
DP, ONE WAY MCB DB	BCHOWMCBDBDP		745
TP, ONE WAY MCB DB	BCHOWMCBDBTP		805
FP, ONE WAY MCB DB	BCHOWMCBDBFP		805

RCCB



RCCB, Double Pole

HSN Code : 8536

Description	Cat. No.	MRP [₹]
25A - 30mA	BCHRCCR030DPC25	4135
40A - 30mA	BCHRCCR030DPC40	4225
63A - 30mA	BCHRCCR030DPC63	5675
25A - 100mA	BCHRCCR100DPC25	4180
40A - 100mA	BCHRCCR100DPC40	4335
63A - 100mA	BCHRCCR100DPC63	5795
25A - 300mA	BCHRCCR300DPC25	4180
40A - 300mA	BCHRCCR300DPC40	4640
63A - 300mA	BCHRCCR300DPC63	5795

All above RCCB's are 'AC' type



RCCB, Four Pole

HSN Code : 8536

Description	Cat. No.	MRP [₹]
25A - 30mA	BCHRCCR030FPC25	5325
40A - 30mA	BCHRCCR030FPC40	5480
63A - 30mA	BCHRCCR030FPC63	6165
25A - 100mA	BCHRCCR100FPC25	5480
40A - 100mA	BCHRCCR100FPC40	5715
63A - 100mA	BCHRCCR100FPC63	6165
25A - 300mA	BCHRCCR300FPC25	5480
40A - 300mA	BCHRCCR300FPC40	5745
63A - 300mA	BCHRCCR300FPC63	6165

All above RCCB's are 'AC' type

- Zone:** Effects
- Zone 1:** Usually no reactions.
- Zone 2:** Usually no harmful effects.
- Zone 3:** Muscle cramps can occur. There is normally no danger of ventricular fibrillation.
- Zone 4:** Ventricular fibrillation may occur which can be fatal.



RCCB, Double Pole

HSN Code : 8536

Description	Cat. No.	MRP [₹]
25A - 30mA	BCHRCB030DPC25	4210
40A - 30mA	BCHRCB030DPC40	4300
63A - 30mA	BCHRCB030DPC63	5775
25A - 100mA	BCHRCB100DPC25	4250
40A - 100mA	BCHRCB100DPC40	4410
63A - 100mA	BCHRCB100DPC63	5905
25A - 300mA	BCHRCB300DPC25	4250
40A - 300mA	BCHRCB300DPC40	4720
63A - 300mA	BCHRCB300DPC63	5905

All above RCCB's are 'AC' type



RCCB, Four Pole

HSN Code : 8536

Description	Cat. No.	MRP [₹]
25A - 30mA	BCHRCB030FPC25	5420
40A - 30mA	BCHRCB030FPC40	5585
63A - 30mA	BCHRCB030FPC63	6280
25A - 100mA	BCHRCB100FPC25	5585
40A - 100mA	BCHRCB100FPC40	5825
63A - 100mA	BCHRCB100FPC63	6280
25A - 300mA	BCHRCB300FPC25	5585
40A - 300mA	BCHRCB300FPC40	5845
63A - 300mA	BCHRCB300FPC63	6280

All above RCCB's are 'AC' type

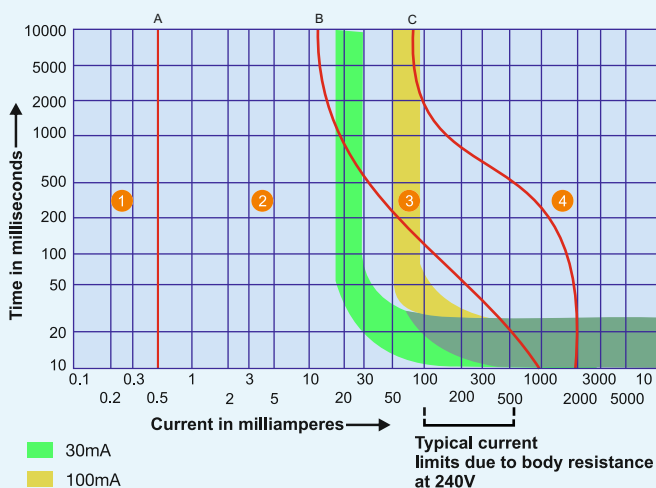

Effect of Current

Zone	Effects
Zone 1	Usually no reactions
Zone 2	Usually no harmful effects
Zone 3	Muscle cramps can occur. There is normally no danger of ventricular fibrillation.
Zone 4	Chances of ventricular fibrillation increased upto 5% (Curve C2) upto 50% (Curve C3) and above 50% beyond Curve C3. Effects such as cardiac arrest, breathing arrest and heavy burns may also occur.

MCB - SELECTION CHART

	Appliances	Capacity	AMP	MCB Type
	Washing Machine	10KG	10A	C Type
	Air-Conditioner	1.0 T 1.5 T 2.0 T	16A 20A 20A	C Type C Type C Type
	Oven + Griller	1750 W 4500 W	10A 25A	B Type B Type
	Oven	750 W	6A	B Type
	Toaster	1200 W	10A	B Type
	Mixer	200 W	2A	C Type
	Refrigrator	165 L 350 L	4A-6A	C Type C Type
	Electric Geyser	4000 W	20A	B Type
	Electric Iron	750 W	6A	B Type
	Electric Kettle	1500 W	10A	B Type



BCH

Price List

General Terms & Conditions

Prices are subject to change without any prior notice and will be applicable as prevailing at the time of dispatch.

- The prices are ex-works basis..
- The prices given in this list are effective as on date and are subject to change without notice.
- The List Prices (LP) mentioned are exclusive of GST.
- The duties, taxes and other statutory levies are based on rates prevailing at the time of billing. Any subsequent revision of those rates having retrospective effective shall be to customer's account.
- In case where any GST exemption has been claimed, the purchaser is responsible for providing the necessary GST exemption form within the specified period, failing which the purchaser would be liable for the payment of full GST plus applicable interest and penalties
- All Prices are in Indian Rupees (₹).
- Alteration made after receipt of confirmation of order are subject to price & delivery revisions and any other expenses or levies
- The dispute, if any, will be resolved mutually by discussion. However, if no settlement is forthcoming then, the Courts at New Delhi shall only have territorial jurisdiction to hear and decide the dispute.

Warranty

All products, unless specifically mentioned otherwise, shall have warranty, against manufacturing defects for a period of 18* months from the date of invoicing & 24 months from date of manufacturing whichever is later subject to the provision of proper usage and does not cover defects arising out of fire, accident, inefficient maintenance, faulty operation and willful or accidental damage. The manufacturer shall not be liable for any consequential loss, injury or damages attributable to defect or failure of its products.

* Proof of purchase to be retained to avail warranty.

- Power Control Products
- Starters & Submersible Pump Starters
- Industrial Enclosures
- Industrial Products
- Wires & Cables
- Motor Control Products
- Power Bus Duct
- Customised Solution
- Automation

a strong commitment to serve better always ...



BCH ELECTRIC LIMITED



1800-103-9262

customercare@bchindia.com

Visit us at : www.bchindia.com

Registered & Corporate Office : 1105, New Delhi House, 27, Barakhamba Road, New Delhi - 110 001 Tel. : 91-11- 43673100

CIN : U31103DL1965PLC425953, **Customercare No.** 1800-103-9262, **E-mail :** marketing@bchindia.com

Works 1 : 20/4, Mathura Road, Faridabad - 121 006 (Haryana) Tel. : 0129-4063000/4293000 Fax : 0129-2304016

Works 2 : 64-68, Sector-7, IIE, Pant Nagar, Rudrapur, Udham Singh Nagar - 263 153 (Uttarakhand) Tel. : 05944-250214/16 Fax : 05944-250215

Sales Offices :

Ahmedabad
401, Ship Zeveri,
Beside Shyamal Iconic,
Above Westside,
Shyamal Cross Road,
Ahmedabad - 380015
E-mail: ahmedabad@bchindia.com

Bangalore
2nd Floor, 130/5,
K.H. Road (Double road),
Bangalore - 560 027
Tel. : 080-41144879 / 22236759
E-mail : bangalore@bchindia.com

Bhubaneswar
Mallick Commercial
Complex Plot No.: A/69, unit - 3
Bhubaneswar - 751 001
Tel.: 0674-2380988
E-mail: bhubaneswar@bchindia.com

Chandigarh (Panchkula)
SCO -270, 2nd Floor,
Sector-16, Panchkula
Haryana-134 113
Tel.: 0172-5078957 / 5049905
E-mail : chandigarh@bchindia.com

Chennai
Flat No. 3A, 3rd Floor,
Sree Apartments,
No.508, TTK Road,
Alwarpet, Chennai 600 018
Tel.: 044-66237046, 24337047
E-mail : chennai@bchindia.com

Coimbatore
87, Dr. Nanjappa Road,
Coimbatore - 641 018
Tel.: 0422-2305311 / 2302599
E-mail : coimbatore@bchindia.com

Delhi 1
801, Akash Deep Building,
26A, Barakhamba Road,
New Delhi - 110 001
Tel. : 011-23313878 / 43518200
E-mail : delhi@bchindia.com

Delhi 2
710, Deepali Building, 92
Nehru Place, New Delhi - 110
019 Tel. : 011-45720334
E-mail : delhi2@bchindia.com

Dehradun
8, Co-operative Industrial Estate,
Patel Nagar, Dehradun-248001
E-mail : dehradun@bchindia.com

Faridabad
20/4, Mathura Road,
Faridabad - 121 006 (Haryana)
Telfax : 0129-4293009
E-mail : faridabad@bchindia.com

Hyderabad
1-8-303/48/13/102, Arya One,
2nd Floor, P. G. Road,
Secunderabad - 500 003
Tel. : 040-66206263/27890306
Fax : 040-66207273
E-mail : hyderabad@bchindia.com

Indore
330-331, Indraprastha Tower,
3rd Floor, 6, M.G. Road,
Indore - 452 001
Tel. : 0731-2510011 / 2510012
E-mail : indore@bchindia.com

Jaipur
25, Hathroi, Gopalbari,
Jaipur - 302 001
Tel. : 0141-2363521
E-mail : jaipur@bchindia.com

Jamshedpur
A.J. Tower, 2B,
2nd Floor, R-Road, Bistupur,
Jamshedpur - 831 001
E-mail : jamshedpur@bchindia.com

Kolkata
Block 1E, 216,
Acharya Jagadish Chandra Bose
Road, Kolkata - 700 017
Tel. : 033-22871728 / 46021884
E-mail : kolkata@bchindia.com

Lucknow
Shop No. 3, First Floor,
Tower T-10, Millennium Place IBB - 2,
Sushant Golf City, Sultanpur Road,
Lucknow U.P. - 226030
Tel. : 0522-4025597/4025997
E-mail : lucknow@bchindia.com

Ludhiana
S.C.O.- 18, 2nd Floor,
Feroze Gandhi Market,
Ludhiana - 140 001
Tel. : 0161-5021807/5022808
E-mail : ludhiana@bchindia.com

Madurai
12, Parvathi Plaza-3rd Floor,
70 Feet Road, Ellis Nagar
Madurai-625016, Tamilnadu
Email: madurai@bchindia.com

Mumbai
A-151, Mittal Tower,
Nariman Point,
Mumbai - 400 021
Tel. : 022-22822947/22850162
Fax : 022-22822858
E-mail : mumbai@bchindia.com

Patna
No.703, 7th Floor, Luv Kush
Tower, Exhibition Road,
Patna - 800001

Pune
8, Sarosh Bhavan,
16-B/1, Dr. Ambedkar Road,
Pune - 411 001
Tel. : 020-41210002
E-mail : pune@bchindia.com

Raipur
6th Floor, Office No. 607,
Babylon Capital, Near Oswal
Petrol Pump, VIP Chowk,
G.E. Road, Raipur - 492 006
Tel. : 0771-4045053
E-mail : raipur@bchindia.com

Vadodara
301, Third Floor, "Florence Classic",
10, Ashapur Co-Op. Hsg. Soc. Ltd., Opp. VUDA
Housing, Near Cow Circle, Akota, Vadodara - 390 020
Tel. : 0265-2345068/2345069
Telefax : 0265-2345068,
E-mail : vadodara@bchindia.com

Other Branch Locations

Cochin : cochin@bchindia.com, **Guwahati :** guwahati@bchindia.com, **Vishakapatnam :** vizag@bchindia.com, **Surat :** surat@bchindia.com, **Trichy :** Trichy@bchindia.com

Resident Engineer Locations

Agra	Bhopal	Hospet	Kanpur	Muzaffarnagar	Rajahmundry	Silliguri	Varanasi
Ahmednagar	Calicut	Hubli	Karimnagar	Nanded	Ranchi	Solapur	Vijaywada
Ambala	Goa	Idukki	Karnal	Nashik	Rourkela	Srinagar	Vishakapatnam
Anantapur	Gulbarga	Jabalpur	Kota	Panipat	Rudarpur	Trivendrum	Vellore
Ankleshwar	Gurgaon	Jalandhar	Kurnool	Patna	Salem	Tirunelveli	Vilupuram
Aurangabad	Haridwar	Jodhpur	Midnapore	Puducherry	Sikar	Udaipur	Warangal
Bhiwadi	Hisar	Kashipur	Mahua	Rajkot	Silchar	Vapi	Yamunanagar

Since product improvement is a continuous process, the data furnished in this brochure may undergo revision without prior notice.



BCH
ELECTRIC
LIMITED



MOTOR STARTERS

Price List effective 17th November 2025



*Farmer's trusted
irrigation partner
Since 1965*

Modern facilities at Faridabad & Rudrapur



Our Strengths

- ◆ State-of-the-art product development and R&D
- ◆ Modern manufacturing facilities
- ◆ Tool room with latest facilities
- ◆ Serving customers for five decades
- ◆ Presence in ~50 locations
- ◆ 650 channel partners
- ◆ ISO 9001:2015 & ISO 14001:2015, ISO 45001: 2018 certified company

Core Values

- ◆ Integrity
- ◆ Nurturing People
- ◆ Commitment to Customers
- ◆ Striving for Excellence
- ◆ Long Term Thinking

Quality Policy

We as a member of BCH Electric Limited manufacturer of Low Voltage Switchgear & Controlgear products, are fully committed to provide Quality products and service in compliance with applicable Statutory and Regulatory requirements, to meet or exceed the customer need and expectations through -

- ◆ Continual improvement
- ◆ Involvement of employees
- ◆ Setting Quality objectives
- ◆ Training and development of employees

Health & Safety Policy

We as a member of BCH Electric Limited manufacturer of Low Voltage Switchgear & Controlgear products, are fully committed to conduct Business in compliance to applicable Health & Safety legislation and regulation.

We shall continually improve through -

- ◆ Provide Safe & Healthy working conditions for the prevention of work related injury and ill health.
- ◆ Develop & maintain the Health & Safety objectives & targets and conduct health & safety programs for achieving the objectives and target.
- ◆ The prevention of accidents through the identification, assessment and elimination of workplace hazards and the promotion of health & safety awareness among its employees and contractors.
- ◆ Encourage employee's participation and consultation in matters affecting the health, safety and well being of our people and seek suggestions from our employees of ways in which health, safety & well being can be furthered.

The Health & safety policy is publicly available on request.

Environmental Policy

We as a member of BCH Electric Limited manufacturer of Low Voltage Switchgear & Controlgear products, are fully committed to conduct Business in compliance to applicable Environmental legislation and regulation.

We shall continually improve through -

- ◆ Provide a framework for setting and reviewing environmental objectives and targets.
- ◆ Regularly review the impact of our activities on environment and strive to reduce the pollution/waste.
- ◆ Involve employees in our environmental program and provide necessary training to enable them to discharge their responsibilities towards environment management.
- ◆ Sustain the program of continual improvement in environment in environmental performance incorporating suitable metrics and monitoring.

The Environment policy is publicly available on request.



www.bchindia.com



BCH

Motor Starters & Submersible Pump Starters

Motor Starters 01-08

	Page No.
■ Shakti - DOL (Shakti WP & Shakti) & Auto DOL Starters	09
■ Shakti - Semi & Fully Automatic Star Delta Starters	10
■ Citation DOL, Citation P - DOL & Auto DOL New	11
■ Citation - SASD, FASD, Higher HP FASD Starters	12
■ BK1 DOL & SASD Starters & Spares New	13
■ FASD with EOCR, Industrial DOL & Reversing DOL	14
■ Mini Manual DOL 1Ph & 3Ph, DOL-1Ph & Manual SD Starter New	15

Submersible Pump Starters 09-15

■ 3-Ph SPS - Citation - DOL & SD and Shakti - DOL New	17
■ 3-Ph SPS - Citation P - DOL & SD (Standard & Premium)	18
■ 3-Ph SPS - Citation P - SD (Range Extension) New	18
■ 3-Ph SPS - Shakti P - DOL, 1-Ph DOL Starter & SPP Pro	19
■ 1-Ph SPS (with CPG Contactor)	20
■ 1-Ph SPS - Alfa Model & Dry Run Protection Panel New	21
■ 1-Ph SPS - CPD Model & Mini Manual	22

New Oil Immersed Starters & Spares 16

■ Oil Immersed DOL & Star Delta Starters (SASD & FASD)	23
--	----

Others 17-21

■ Contactors - (2P CPG, 4P NHD & 1 Aux + 3P) & Citation Series	24
■ Overload Relays - Citation 3P, WP 3P & 2P	25
■ Spares for Motor Starters & Panels	26
■ Spare Contact Kits, Coils & Carrier for Motor Starters	27
■ Spares for P series SPS, Dry Run SPS, Dual Meter & FR OLR	27
■ Coil Band Master Table	28

MCB / MCCB 29

Wires & Cables 30



BCH i-Pro

The intelligent upgrade for traditional motor starters

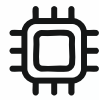

Smarter: Micro controller based protection design for advanced reliability and safety



Advanced: Digital voltmeter and ammeter for real-time, accurate monitoring



Powerful: Suitable for starters up to 40A, robust performance for demanding needs

ONE DEVICE **8** FUNCTIONS,
Save Cost, Space & Installation Time

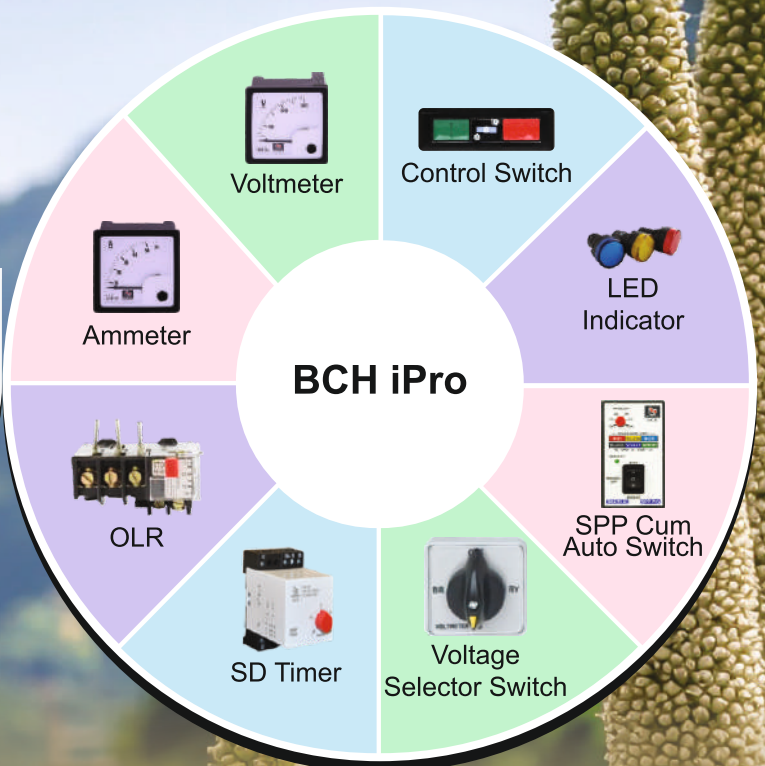

BCH
ELECTRIC
LIMITED

BCH MC range

Total pump control- Anytime, Anywhere

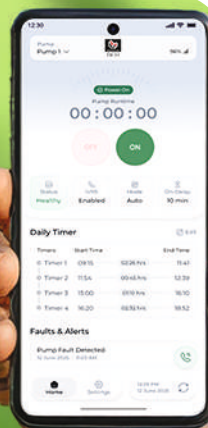

3 in 1
Smart Device:

SPP + Dry Run Protection + Mobile Controller = **BCH MC range**



Remote control & Monitoring

- Operate your pump from **anywhere, at any time.**
- Control via **SMS, Call, Mobile App or WhatsApp.**
- Accessible to all with **24 Local Language Support.**



Complete Motor Protection

- Safeguards against electrical faults: **Over/Under Voltage, Phase Loss, Phase Unbalance, and Phase Reversal.**
- Prevents damage with **Dry Run Protection.**



BCH
ELECTRIC
LIMITED

BCH Smart Controller

Total Protection, Connected Control



Protect your pump, Power your productivity



Smarter Water Management:

- **Digital Metering:** Monitor vital parameters like Voltage, Current, Power Factor, Power, and Energy Consumption directly from the device or app.
- **24 Local Language Support:** The companion app speaks your language, breaking down barriers and ensuring ease of use for everyone across the region.



Command Your Pump from Your Pocket:

- **Missed Call / IVRS:** No internet needed! Start/stop your pump with a simple missed call or interactive voice call.
- **SMS & Mobile App:** Get real-time status alerts and send commands via text or a user-friendly app.
- **WhatsApp Integration:** Receive notifications and send commands directly through the world's most popular messaging platform.



Never worry about pump failure again:

- Safeguards against electrical faults: **Over/Under Voltage, Phase Loss, Unbalance, and Reversal.**
- Prevents damage with **Dry Run Protection.**
- Secures your asset with **Anti-Theft Alerts.**



BCH
ELECTRIC
LIMITED

BK DOL

Powering an Uncompromising Rural India



1

Rugged, Corrosion-Resistant Enclosure

A heavy-duty powder-coated box that stands strong against rust and harsh weather, ensuring long-lasting performance

2

Superior Protection from Moisture

Features a modern, PVC-wrapped copper wire coil engineered to defeat damage from moisture, significantly extending the motor's lifespan

3

Built for Heavy-Duty Applications

A robust contact kit designed to handle high starting currents and torque loads with absolute reliability, making it perfect for demanding industrial and agricultural uses

4

Agriculture-Specific Overload Relay

An overload relay specifically crafted for farming conditions, offering unmatched protection against overload to prevent motor burnouts



BCH
ELECTRIC
LIMITED

Built Rugged, Driven by Reliability

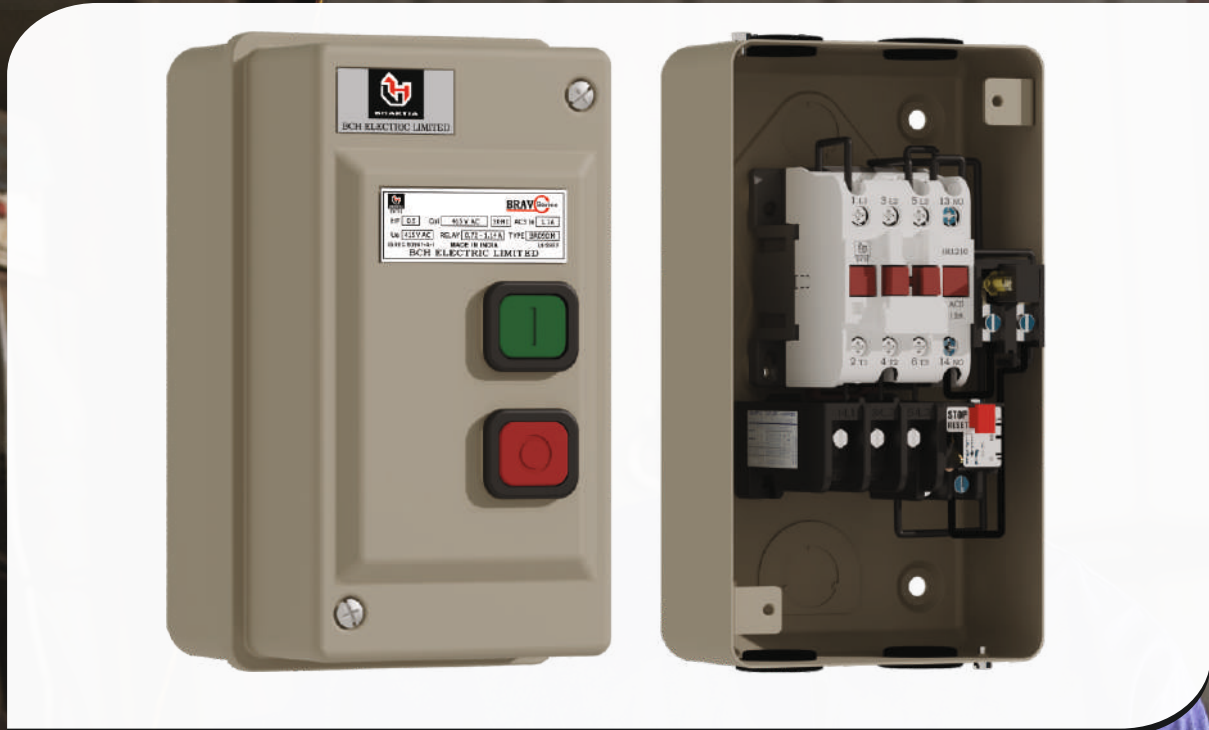

Versatile Application:

Perfect for small motors upto 10HP across various industries such as pumps, fan, machine tools etc.



Rugged & Proven:

Industrial-grade contactor built for harsh conditions



Reliable Protection:

Safeguards against overloads with best in class OLR and auto resetting



Simple to Use:

Easy installation and maintenance minimize downtime



BCH

**BCH
ELECTRIC
LIMITED**

Nano+ Starter

Compact Power, Uncompromising Reliability

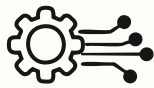

Integrated Motor Protection

A pre-assembled solution with built-in protections and monitoring that saves installation time and actively extends motor life



Built for Indian Conditions

A specialized **plastic enclosure** designed to withstand dust, moisture, and extreme temperatures



40% less space

Our radically compact design is a game-changer. Neater installation and easier maintenance



Unmatched Reliability

Equipped with a robust **NHD contactor** to ensure durability and long-term operation in harsh condition



BCH
ELECTRIC
LIMITED



Shakti DOL & Star Delta Starters

- DOL & Star Delta upto 24 A relay range
- Heavy duty Shakti Contactor
- Wide Band coil voltages (190-400V, 230-420V, 220-240V, 380-415V)
- Encapsulated & Hermetically sealed coil
- Automatic star delta with electronic timer for reliable changeover from star to delta
- Selection of manual & auto resetting of overload relay



Citation DOL & Star Delta Starters

- DOL upto 40 HP
- Semi Automatic upto 40 HP
- Fully Automatic upto 375 HP
- Heavy Duty NHD & Citation Contactor
- Wide Band Coil Voltage (230-360V, 260-400V, 380-415V)
- Automatic Star Delta with Pneumatic Time for Reliable Changeover from Star to Delta
- Selection of Manual & Auto Resetting of Overload Relay



Shakti & Citation P Auto DOL Starters

- Shakti range available upto 24 A overload relay
- Citation P range available upto 40 A overload relay
- Auto start with on delay options:- 5 sec or 5 min or 0.5 sec to 5 min
- Mode of operation:- Auto/ Manual/ Manual SPP with selector on enclosure switch or SPP with inbuilt selector switch
- Protection against phase reversal, phase imbalance & single phasing



BK1 DOL & Semi Automatic Star Delta Starters

- Range: DOL upto 7.5 H.P
- Range: Star Delta upto 15 H.P
- Wide Band Coil 250-400 V AC & 200-400 VAC



1-Phase DOL Starter

- Starter With 2 Pole CPGN Contactor and 2 Pole Overload Relay
- Encapsulated & Hermetically Sealed Coil
- Selection of Manual & Auto Resetting of Overload Relay
- Power Coated Deep Drwan Sheet Steel Enclosure for Excellent Finish & Durability



Mini Manual Starters

- Range Available upto 10 HP (3PH) & upto 3HP (1PH)
- Flush & Base Mounting Version Available
- Trips Automatically in Low Voltage Conditions (with UV Coil)
- Prevents Motor From Restarting When Powder Comes Back



Cat. No.	Overload Relay Range (A)	Contactor Type	Contactor Rating (AC-3)	MRP [₹]	Cat. No. (Open Execution)	MRP [₹]
SAWPGZA	2.4 - 3.8	Shakti	12 A	3480	-	-
SAWPHZA	3.8 - 6.0				-	-
SAWPJZA	6.0 - 9.3				-	-
SAWPGZ	2.4 - 3.8		20 A	3545	SAWPGZI	3515
SAWPHZ	3.8 - 6.0				SAWPHZI	
SAWPJZ	6.0 - 9.3				SAWPJZI	
SAWPKZ	8.9 - 13.5				SAWPKZI	
SAWPLZ	13.2 - 20.0			3730	SAWPLZI	3710
SAWPMZ	17.4 - 24.0			3880	SAWPMZI	3860

Shakti WP DOL Starter (Big Enclosure + TB)

HSN CODE : 8536

Cat. No.	Overload Relay Range (A)	Contactor Type	Contactor Rating (AC-3)	MRP [₹]
SAWPKZ-BT	8.9 - 13.5	Shakti	20 A	4670
SAWPLZ-BT	13.2 - 20.0			4860
SAWPMZ-BT	17.4 - 24.0			5120



Shakti DOL Starter (190-400V AC Coil)

HSN CODE : 8536

Cat. No.	Overload Relay Range (A)	Contactor Type	Contactor Rating (AC-3)	MRP [₹]	Cat. No. (Open Execution)	MRP [₹]
SAGZ	2.4 - 3.8	Shakti	20 A	3750	SAGZI	3720
SAHZ	3.8 - 6.0				SAHZI	
SAJZ	6.0 - 9.3				SAJZI	
SAKZ	8.9 - 13.5			SAKZI	4060	
SALZ	13.2 - 20.0			SALZI		
SAMZ	17.4 - 24.0			SAMZI		4225



Shakti Auto-Start DOL Starter (With 5-Sec Delay Auto Switch)

3 Position Selection (Manual - Manual SPP - Auto)

HSN CODE : 8536

Cat. No.	Overload Relay Range(A)	Contactor Type	Contactor Rating (AC-3)	MRP [₹]
ASXGZ	2.4 - 3.8	Shakti	20 A	6190
ASXHZ	3.8 - 6.0			
ASXJZ	6.0 - 9.3			
ASXKZ	8.9 - 13.5			6495
ASXLZ	13.2 - 20.0			
ASXMZ	17.4 - 24.0			

For other Coil Voltages, kindly refer 'Coil Voltage Master Table' at page 28

Shakti Semi Automatic Star Delta Starter with 260-400V AC Coil

HSN CODE : 8536



Cat. No.	Overload Relay Range (A)	Contactor Type	Contactor Rating (AC-3)	MRP [₹]
SASSGLEG	2.4 - 3.8	Shakti	16 A	12595
SASSHLEG	3.8 - 6.0			
SASSJLEG	6.0 - 9.3			
SASSKLEG	8.9 - 13.5			12850
SASSKLEG/LOR	13.2 - 20.0			
SASSKLEG-M	17.4 - 24.0			

Shakti Fully Automatic Star Delta Starter with 260-400V AC Coil & Electronic Timer

HSN CODE : 8536



Cat. No.	Overload Relay Range (A)	Contactor Type	Contactor Rating (AC-3)	MRP [₹]
SASAGLEG	2.4 - 3.8	Shakti	16 A	13865
SASAHLEG	3.8 - 6.0			
SASAJLEG	6.0 - 9.3			
SASAKLEG	8.9 - 13.5			14095
SASAKLEG/LOR	13.2 - 20.0			
SASAKLEG/MOR	17.4 - 24.0			

For 380 - 415 V Coil Voltage replace Suffix 'G' by 'N'

For other Coil Voltages, kindly refer 'Coil Voltage Master Table' at page 28



Citation DOL Motor Starter

HSN CODE : 8536

Cat. No.	HP / KW at 3Ø, 415V, 50Hz	Overload Relay Range (A)	Contactor Type	Contactor Rating (AC-3)	MRP [₹]	Cat. No. (Open Execution)	MRP [₹]
NADLEN	0.5 / 0.37	0.72 - 1.14	C00N	16 A	4935	NADLENI	4800
NAELEN	0.75 / 0.55	1.07 - 1.70	C00N	16 A	4935	NAELENI	4800
NAFLEN	1 / 0.75	1.58 - 2.50	C00N	16 A	4935	NAFLENI	4800
NAGLEN	2 / 1.5	2.4 - 3.8	C00N	16 A	4935	NAGLENI	4800
NAHLEN	3 / 2.2	3.8 - 6.0	C00N	16 A	4935	NAHLENI	4800
NAJLEN	5 / 3.7	6.0 - 9.3	C00N	16 A	4935	NAJLENI	4800
NAKLEN	7.5 / 5.5	8.9 - 13.5	C00N	16 A	4935	NAKLENI	4800
NALLEN	10 / 7.5	13.2 - 20.0	C00N	16 A	5230	NALLENI	5090
NALLEN/CP20	10 / 7.5	13.2 - 20.0	CP20	20 A	5870		
NALLEN/MOR	12.5 / 10	17.4 - 24.0	CP20	20 A	6095	NALLENI/MOR	6100



Citation DOL Motor Starter (A) with NHD Contactor

HSN CODE : 8536

Cat. No.	HP / KW at 3Ø, 415V, 50Hz	Overload Relay Range (A)	Contactor Type	Contactor Rating (AC-3)	MRP [₹]
NAMLEN	15 / 11	17.4 - 24.0	N0N	25A	8210
NAMLEN/NOR	15 / 11	22.0 - 30.0	N0N	25A	8945
NAPLEN/MOR	15 / 11	17.4 - 24.0	N01N	32A	11095
NAPLEN	20 / 15	23.0 - 32.0	N01N	32A	11550
NANLEN	20 / 15	22.0 - 30.0	N1N	40A	12895
NAQLEN	25 / 18.5	26.0 - 40.0	N1N	40A	13090



(B) 30 & 40 HP DOL Starter

Cat. No.	HP / KW at 3Ø, 415V, 50Hz	Overload Relay Range (A)	Contactor Type	Contactor Rating (AC-3)	MRP [₹]
CEHFRGDM*	30 / 22	36.0 - 52.0 (FR OLR)	Freedom	50A	21720
NACT2LEDM	30 / 22	37.6 - 60.0	Citation D	40A	28775
NACT2LEEM	40 / 30	37.6 - 60.0	Citation E	70A	38320



Citation P DOL Motor Starter New

HSN CODE : 8536

Type	Cat. No.	Coil	HP/ KW at 3Ø, 415V, 50Hz	Overload Relay Range (A)	Contactor Rating (AC-3)	MRP [₹]
P2	NBMLEN/LOR	N & G	10 / 7.5	13.2 - 20	25A	6415
P2	NBMLEN	N & G	15 / 11	17.4 - 24	25A	6560
P2	NBMLEN/POR	N & G	15 / 11	23 - 32	25A	6870
P3	NBPLEN	N & WB	20 / 15	23 - 32	32A	8065
P3	NBPLEN/QOR	N & WB	20 / 15	26 - 40	32A	8370
P3H	NBQLEN	N & WB	25 / 18.5	26 - 40	40A	10245



Citation P Auto DOL Motor Starter New

HSN CODE : 8536

Type	Cat. No.	Coil	HP/ KW at 3Ø, 415V, 50Hz	Overload Relay Range (A)	Contactor Rating (AC-3)	MRP [₹]
P1A	ANBKLEN	N & G	7.5 / 5.5	8.9 - 13.5	16A	7060
P1A	ANBLEN	N & G	10 / 7.5	13.2 - 20	16A	7180
P1HA	ANBLEN/MOR	N & G	12.5 / 10	17.4 - 24	20A	7570
P1HA	ANBLEN/POR	N & G	12.5 / 10	23 - 32	20A	7790
P2A	ANBMLEN	N & G	12.5 / 10	17.4 - 24	25A	8620
P2A	ANBMLEN/POR	N & G	15 / 11	23 - 32	25A	8970
P3A	ANBPLEN	N & WB	20 / 15	23 - 32	32A	9750
P3A	ANBPLEN/QOR	N & WB	20 / 15	26 - 40	32A	9860
P3HA	ANBQLEN	N & WB	22.5 / 16.8	26 - 40	40A	11395



For other Coil Voltages, kindly refer 'Coil Voltage Master Table' at page 28

Citation Semi Automatic Star Delta Starter with NHD Contactor

HSN CODE : 8536



Cat. No.	HP / kW at 3Ø, 415V, 50Hz	Overload Relay Range (A)	Contactors Type	Contactors Rating (AC-3)	MRP [₹]
NASSHLEN	10 / 7.5	6.0 - 9.3	C00N	16A	13565
NASSJLEN	10 / 7.5	6.0 - 9.3	C00N	16A	13565
NASSKLEN	15 / 11	8.9 - 13.5	C00N	16A	13565
NASSKLEN/LOR	15 / 11	13.2 - 20.0	C00N	16A	13990
NASSLLEN	20 / 15	13.2 - 20.0	N0N	25A	21485
NASSMLEN	25 / 18.5	17.4 - 24.0	N0N	25A	21620
NASSPLEN	25 / 18.5	23.0 - 32.0	N0N	25A	23900
NASS01PLEN	35 / 26	23.0 - 32.0	N01N	32A	27655
NASS01QLEN	40 / 30	26.0 - 40.0	N01N	32A	27900
NASSNLEN	35 / 26	22.0 - 30.0	N1N	40A	40470
NASS01CT1LEN	40 / 30	24.4 - 39.0	N01N	32A	39050
NASSFRGCLEC4M	40 / 30	29-42 (FR OLR)	C4	32A	42145

Citation Fully Automatic Star Delta Starter with NHD Contactor & Pneumatic Timers

HSN CODE : 8536



Cat. No.	HP / KW at 3Ø, 415V, 50Hz	Overload Relay Range (A)	Contactors Type	Contactors Rating (AC-3)	MRP [₹]
NASAGLEN	3 / 2.2	2.4 - 3.8	C00N	16A	18665
NASAHLEN	5 / 3.7	3.8 - 6.0	C00N	16A	18665
NASAJLEN	10 / 7.5	6.0 - 9.3	C00N	16A	18665
NASAKLEN	15 / 11	8.9 - 13.5	C00N	16A	18665
NASAKLEN/LOR	15 / 11	13.2 - 20.0	C00N	16A	19570
NASALLEN	20 / 15	13.2 - 20.0	N0N	25A	24600
NASAMLEN	25 / 18.5	17.4 - 24.0	N0N	25A	24735
NASAPLEN	30 / 22	23.0 - 32.0	N0N	25A	25760
NASA01PLEN	35 / 26	23.0 - 32.0	N01N	32A	32780
NASANLEN	35 / 26	22.0 - 30.0	N1N	40A	46525
NASAQLEN	40 / 30	26.0 - 40.0	N1N	40A	46795
NASACT1LEN	40 / 30	24.4 - 39.0	N1N	40A	50390

Citation Fully Automatic Star Delta Starter with Citation M Contactor & Pneumatic Timers

HSN CODE : 8536



Cat. No.	HP / KW at 3Ø, 415V, 50Hz	Overload Relay Range (A)	Contactors Type	Contactors Rating (AC-3)	MRP [₹]
NASACT1LEDM	40 / 30	24.4 - 39.0	D	40A	59855
NASACT2LEDM	50 / 37	37.6 - 60.0	D	40A	60810
NASACT2LEEM	75 / 55	37.6 - 60.0	E	70A	104000
NASACT3LEEM	85 / 65	56.4 - 90.0	E	70A	111125
NASACT3LEC5M	100 / 75	56.4 - 90.0	M-5	110A	143900
NASACT4LEC5M	135 / 100	84.6 - 135.0	M-5	110A	147125
NASACT4LENM	150 / 110	84.6 - 135.0	N	140A	202830
NASACT5LEC6M	250 / 185	131.6 - 210.0	S	300A	279615
NASACT6LEC6M	375 / 280	188.0 - 300.0	S	300A	337695

For other Coil Voltages, kindly refer 'Coil Voltage Master Table' at page 28

Motor Starters-BK1

New



BK1 DOL Motor Starter

HSN CODE : 8536

Type	Cat. No.	HP/ KW at 3Ø, 415V, 50Hz	Overload Relay Range (A)	Contactor Rating (AC-3)	MRP [₹]
BK1 DOL	BK1DBEWB1	0.75 HP	1-1.6	16A	2845
BK1 DOL	BK1DBFWB1	1 HP	1.5-2.5	16A	2845
BK1 DOL	BK1DBGWB1	2 HP	2.5-4	16A	2845
BK1 DOL	BK1DBHWB1	4 HP	4-6.5	16A	2845
BK1 DOL	BK1DBJWB1	6 HP	6-10	16A	2845
BK1 DOL	BK1DBKWB1	7.5 HP	9-14	16A	2845
BK1 DOL	BK1DBKLWB1	7.5 HP	11-18	16A	2905
BK1 DOL	BK1DBLWB1	7.5 HP	13-22	16A	2980
Bk2 DOL	BK2DBKWB1	7.5 HP	9-14	25A	3510
Bk2 DOL	BK2DBKLWB1	7.5 HP	11-18	25A	3510
BK2 DOL	BK2DBLWB1	7.5 HP	13-22	25A	3510
BK2 DOL	BK2DBPWB1	7.5 HP	20-32	25A	3510

*WB1 - 250-450V (415V) *WB2 - 200-400V (360V)

BK1 Semi-Automatic Motor Starter

HSN CODE : 8536

Type	Cat. No.	HP/ KW at 3Ø, 415V, 50Hz	Overload Relay Range (A)	Contactor Rating (AC-3)	MRP [₹]
BK1 SASD	BK1SSBHWB1	6 HP	4-6.5	16A	10975
BK1 SASD	BK1SSBJWB1	10 HP	6-10	16A	10975
BK1 SASD	BK1SSBKWB1	12.5 HP	9-14	16A	10975
BK1 SASD	BK1SSBKLBW1	15 HP	11-18	16A	11060
BK1 SASD	BK1SSBLWB1	15 HP	13-22	16A	11195
BK2 SASD	BK2SSBLWB1	15 HP	13-22	25A	12295
BK2 SASD	BK2SSBPWB1	15 HP	20-32	25A	12295

BK Contactors

HSN CODE : 8536

Cat. No.	Description	MRP [₹]
BK1C16WB1	Bk1 Contactor, 4P, 16A, 250-450V AC	2110
BK2C25WB1	BK2 Contactor, 4P, 25A, 250-450V AC	2415

BK Overload Relay

HSN CODE : 8536

Cat. No.	Description	MRP [₹]
BK1OLRBE	Overload Relay, 3P, BK, 1-1.6A	1165
BK1OLRBF	Overload Relay, 3P, BK, 1.5-2.5A	1165
BK1OLRBG	Overload Relay, 3P, BK, 2.5-4.0A	1165
BK1OLRBH	Overload Relay, 3P, BK, 4-6A	1165
BK1OLRBJ	Overload Relay, 3P, BK, 6-10A	1165
BK1OLRBK	Overload Relay, 3P, BK, 9-14A	1165
BK1OLRBKL	Overload Relay, 3P, BK, 11-18A	1200
BK1OLRBL	Overload Relay, 3P, BK, 13-22A	1340
BK2OLRBP	Overload Relay, 3P, BK, 20-32A	1490

Spares for BK1 Starters

HSN CODE : 8538

Cat. No.	Description	MRP [₹]
BK1-AS16	Housing (Arc Shield) for BK1 Contactor	165
BK2-AS25	Housing (Arc Shield) for BK2 Contactor	170
BK1-CB16	Contact Bridge for BK1 Contactor	150
BK2-CB25	Contact Bridge for BK2 Contactor	165
BK1-CK16	Contact Kit for BK1 Contactor	960
BK2-CK25	Contact Kit for BK2 Contactor	1355
BKCWB1	Coil 250-450V AC for BK Contactors	320
BKCWB2	Coil 200-400V AC for BK Contactors	320
BK-PB	Twin Push Button for BK Starters	150
BKCB11	Auxiliary contact 1NO+1NC for BK Starter	330
BK1-MC16	Single moving contact for BK1 Contactor	95
BK2-MC25	Single moving contact for BK2 Contactor	130



Fully Automatic Star Delta Starter with Citation M Contactor, Pneumatic Timer & Electronic Over Current Relay with Ammeter & Voltmeter

HSN CODE : 8536



Cat. No.	HP / KW at 3Ø, 415V, 50Hz	EOCR Range (A)	Contactor Type (Citation)	Contactor Rating (AC-3)	MRP [₹]
NASASS60LEDM-P	50 / 37	5-60 Amp	D	40A	72210
NASASS60LEEM-P	75 / 55	5-60 Amp	E	70A	115125
NASA2CTD1CLEM5M-P	100/ 75	0.5-6 Amp (with CT 100/5) (2CT model)	M-5	110A	157065
NASA2CT150LEM5M-P	135/ 100	0.5-6 Amp (with CT 150/5) (2CT model)	M-5	110A	162706

Fully Automatic Star Delta Starter with NHD Contactor, Electronic Timer & Electronic Over Current Relay with Ammeter & Voltmeter and MCB

HSN CODE : 8536

Cat. No.	HP / KW at 3Ø, 415V, 50Hz	EOCR Range (A)	Contactor Type (NHD)	Contactor Rating (AC-3)	MCB Rating	MRP [₹]
NASASS30LEN-P-MCB	25 / 18.5	3-30 Amp	NA25M	25A	40A (TP)	42830

Motor Starters- Freedom

Industrial DOL Starters with Freedom Contactor & Overload Relay

HSN CODE : 8536



Cat. No.	HP / KW at 3Ø, 415V, 50Hz	Overload Relay Type	Overload Relay Range (A)	Contactor Type	Contactor Rating (AC-3)	MRP [₹]
CEBFM	0.5/0.37	Freedom	1.0-1.4	Freedom	9 A	3615
CEBGM	0.75/0.55	Freedom	1.3-1.8	Freedom	9 A	3615
CEBHM	1.0/0.75	Freedom	1.7-2.4	Freedom	9 A	3615
CEBJM	1.5/1.1	Freedom	2.2-3.1	Freedom	9 A	3615
CEBKM	2.0/1.5	Freedom	2.8-4.0	Freedom	9 A	3615
CEBMM	3.0/2.2	Freedom	4.5-6.5	Freedom	9 A	3615
CEBPM	5.0/3.7	Freedom	7.5-11	Freedom	9 A	3615
CECPM	5.0/3.7	Freedom	7.5-11	Freedom	12 A	3715
CECQM	7.5/5.5	Freedom	10-14	Freedom	12 A	3715
CEDQM	7.5/5.5	Freedom	10-14	Freedom	18 A	4690
CEDRM	10/7.5	Freedom	13-19	Freedom	18 A	4690
CECBHM	3.0/2.2	Citation	3.8-6	Freedom	9 A	3615
CECBJM	5.0/3.7	Citation	6-9.3	Freedom	9 A	3615
CECCKM	7.5/5.5	Citation	8.9-13.5	Freedom	12 A	3715
CECDLM	10/7.5	Citation	13.2-20	Freedom	18 A	4690

DOL Reversing Starter

HSN CODE : 8536



Cat. No.	HP / KW at 3Ø, 415V, 50Hz	Overload Relay Range (A)	Contactor Type	Contactor Rating (AC-3)	MRP [₹]
NARFLEN	1/0.75	1.58 - 2.50	C00N	16 A	12070
NARGLEN	2/1.5	2.4 - 3.8	C00N	16 A	12070
NARHLEN	3/2.2	3.8 - 6.0	C00N	16 A	12070
NARJLEN	5/3.7	6.0 - 9.3	C00N	16 A	12070
NARKLEN	7.5/5.5	8.9 - 13.5	C00N	16 A	12070
NARLLEN	10/7.5	13.2 - 20.0	N0N	25 A	16930
NARMLLEN	15/11	17.4 - 24.0	N1N	40 A	22700
NARNLEN	20/15	22.0 - 30.0	N1N	40 A	23970

For other Coil Voltages, kindly refer 'Coil Voltage Master Table' at page 28

1- Phase Mini Manual Motor Starter upto 3HP (Surface Mounting)

HSN CODE : 8536



Cat. No.	Recommended HP 1Ø, 240V	Overload Relay Range (A)	MRP [₹]	Cat. No. (with UV Coil)	MRP [₹]
AMLE-10-SP	-	0.23 - 0.47	1930	AMLEH-10-SP	2470
AMLE-20-SP	-	0.46 - 0.80		AMLEH-20-SP	
AMLE-30-SP	1 / 8	0.85 - 1.55		AMLEH-30-SP	
AMLE-40-SP	1 / 6	1.60 - 3.20		AMLEH-40-SP	
AMLE-50-SP	0.5 / 0.75	3.50 - 6.50		AMLEH-50-SP	
AMLE-60-SP	1 to 2	6.80 - 11.7		AMLEH-60-SP	
AMLE-70-SP	2 to 3	11.0 - 20.0		AMLEH-70-SP	

For flush mounting replace 'E' by 'C' and reduce price by ₹ 50

3- Phase Mini Manual Motor Starter upto 10 HP (Surface Mounting)

HSN CODE : 8536



Cat. No.	Recommended HP 3Ø, 415V	Overload Relay Range (A)	MRP [₹]	Cat. No. (with UV Coil)	MRP [₹]
AMLE-10	-	0.23 - 0.47	2600	AMLEN-10	2860
AMLE-20	-	0.46 - 0.80		AMLEN-20	
AMLE-30	0.50 / 0.75	0.85 - 1.55		AMLEN-30	
AMLE-40	1.00 / 1.50	1.60 - 3.20		AMLEN-40	
AMLE-50	3.00	3.50 - 6.50		AMLEN-50	
AMLE-60	5.00	6.80 - 11.7		AMLEN-60	
AMLE-70	10.00	11.0 - 20.0		AMLEN-70	

For flush mounting replace 'E' by 'C' and reduce price by ₹ 50

1-Phase DOL with 2P Contactor & 2P Overload Relay New

HSN CODE : 8536



Type	Cat. No.	HP/ KW at 1Ø, 220V, 50Hz	Overload Relay Range (A)	Contactor Rating (AC-3)	MRP [₹]
1P10	NAHLEBW-SP	0.75 / 0.55	3.8 - 6.0	16A	2640
1P10	NAJLEBW-SP	1 / 0.75	6.0 - 9.3	16A	2640
1P10	NAKLEBW-SP	1.5 / 1.10	8.9 - 13.5	16A	2640
1P10H	NALLEBW-SP	2 / 1.5	13.2 - 20	25A	2690
1P10H	NAMLEBW-SP	3 / 2.2	17.4 - 24	25A	2770

Manual Star Delta Starter (with 260-400V AC Coil)

HSN CODE : 8536



Cat. No.	HP at 3Ø, 415V, 50Hz	Overload Relay Range (A)	Contactor Type	Contactor Rating (AC-3)	MRP [₹]
HASSGLEG	3 HP	2.4 - 3.8	C00N	16 A	7745
HASSHLEG	5 HP	3.8 - 6.0	C00N	16 A	7745
HASSJLEG	10 HP	6.0 - 9.3	C00N	16 A	7745
HASSKLEG	15 HP	8.9 - 13.5	NON	25 A	8800

HSN CODE : 8538

HASSW15	Spare switch for 15 HP MSD Starter	2985
---------	------------------------------------	------

For other Coil Voltages, kindly refer 'Coil Voltage Master Table' at page 28



Three Phase

- Direct on line : upto 40 A relay rating
- Star Delta : upto 135 A relay rating
- Protections :
 - Phase failure
 - Phase imbalance
 - Phase reversal
- Short Circuit Protection Through MCB/MCCB : In case of Premium models
- Auto Start with on delay options:
 - 0.5Sec to 5Min (Field adjustable) SPP Pro
 - 5Sec
 - 5Min
- Ammeter and Voltmeter
- On/Off and Trip indications
- Powder coated enclosure with PU gasket ensuring excellent finish and reliability
- Provision for connecting Dry run preventor



On/Trip Indicators



Isolated Terminal blocks for better termination



Better esthetic look & easy to maintenance to use of Bus-bar



180 Deg Opening angle

PU Gasket for excellent sealing against dust & water



Single Phase

With Mini DOL (up to 11 - 20 A Relay)

- Premium Model (With Ammeter & Voltmeter)

With 2 Pole Contactor + 2 Pole Relay (up to 40 A Relay)

- Economy Model (With Ammeter)
- Standard Model (With Ammeter & Voltmeter)
- Alfa Model up to 30 A Relay (With Ammeter & Voltmeter)
- With Dry Run Protection Model (Digital Meter)
- CPD Model with MCB (Digital VA Meter)

Citation Submersible Pump Starter with 3-Position Selection (with Auto Switch) with or without MCB option

DOL (3-Ph)

HSN CODE : 8536



Overload Relay Range (A)	Contactor Type	Contactor Rating (AC-3)	DOL (without Short Circuit Protection)		Premium DOL (with Short Circuit Protection) MCB		MCB "C"10kA
			Cat. No.	MRP [₹]	Cat. No.	MRP [₹]	
1.58 - 2.50	C00N	16 A	CPEYNAFN	10915	--	--	--
2.4 - 3.8	C00N	16 A	CPEYNAGN	10915	CPPYNAGN	16050	6A
3.8 - 6.0	C00N	16 A	CPEYNAHN	10915	CPPYNAHN	16050	10A
6.0 - 9.3	C00N	16 A	CPEYNAJN	10915	CPPYNAJN	16050	16A
8.9 - 13.5	C00N	16 A	CPEYNAKN	10915	CPPYNAKN	16050	25A
13.2 - 20.0	C00N	16 A	CPEYNALN	11825	CPPYNALN	17170	32A
17.4 - 24.0	N0N	25 A	CPEYNAMN	13155	CPPYNAMN	19545	40A
23.0 - 32.0	N01N	32 A	CPEYNA01PN	14705	--	--	--

Citation Submersible Pump Starter with 3-Position Selection (with Auto Switch) with or without MCB / MCCB option

STAR DELTA (3-Ph)

HSN CODE : 8536



Overload Relay Range (A)	Contactor Type	Contactor Rating (AC-3)	Star Delta (without Short Circuit Protection)		Premium Star Delta (with Short Circuit Protection) MCB or MCCB		*MCB "C"10kA/ MCCB
			Cat. No.	MRP [₹]	Cat. No.	MRP [₹]	
3.8 - 6.0	C00N	16 A	CPSDEYHN	21425	--	--	--
6.0 - 9.3	C00N	16 A	CPSDEYJN	21425	CPSDPYJN	26185	32A
8.9 - 13.5	C00N	16 A	CPSDEYKN	21425	CPSDPYKN	26185	40A
13.2 - 20.0	C00N	16 A	CPSDEYLN-C00	21810	CPSDPYLN-C00	27185	50A
17.4 - 24.0	CP20	20 A	CPSDEYMN-CP20	23845	--	--	--
13.2 - 20.0	N0N	25 A	CPSDEYLN	26390	CPSDPYLN	32165	50A
17.4 - 24.0	N0N	25 A	CPSDEYMN	27800	CPSDPYMN	34755	63A
23.0 - 32.0	N01N	32 A	CPSDEY01PN	34880	CPSDPY01N	40315	63A
22.0 - 30.0	N1N	40 A	CPSDEYNN	44810	CPSDPYNN	49715	80A/10kA
26.0 - 40.0	N1N	40 A	CPSDEYQN	45465	CPSDPYQN	50405	80A/10kA
24.4 - 39.0	N1N	40 A	CPSDEYCT1N	51525	CPSDPYCT1N	59795	100A/10kA
37.6 - 60.0	Citation E	70 A	CPSDEYCT2M	83075	CPSDPYCT2M	92635	125A/10kA
56.4 - 90.0	Citation E	70 A	CPSDEYCT3M	89170	CPSDPYCT3M	95020	125A/10kA
56.4 - 90.0	Citation M-5	110 A	CPSDEYCT3M	118610	CPSDPYCT3M	125685	125A/ 36/18kA
84.6 - 135.0	Citation M-5	110 A	CPSDEYCT4M	122355	CPSDPYCT4M	134930	200A/ 36/18kA

*Upto 63A MCB & 80A onwards MCCB are used



Shakti DOL Submersible Pump Starter (with Auto Switch) 3-Ph

HSN CODE : 8536



Overload Relay Range (A)	Description	Contactor Rating (AC-3)	3 Position Selection (Manual - Manual SPP - Auto)	
			Cat. No.	MRP [₹]
2.4 - 3.8	Shakti	20 A	CPEYSAGZ	10250
3.8 - 6.0	Shakti	20 A	CPEYSAHZ	10250
6.0 - 9.3	Shakti	20 A	CPEYSAJZ	10250
8.9 - 13.5	Shakti	20 A	CPEYSAKZ	10250
13.2 - 20.0	Shakti	20 A	CPEYSALZ	11335
17.4 - 24.0	Shakti	20 A	CPEYSAMZ	11925

For 380 - 415 V coil voltage replace suffix "Z" with "N" in the Cat. Code

For other Coil Voltages, kindly refer 'Coil Voltage Master Table' at page 28

Citation P Submersible Pump Starter - Standard and Premium versions

DOL (3-Ph)

HSN CODE : 8536



Type	Overload Relay Range (A)	Contactor Rating (AC-3)	Coil	Standard (without Short Circuit Protection)		Premium (with Short Circuit Protection) with MCB		MCB "C"10kA
				Cat. No.	MRP [₹]	Cat. No.	MRP [₹]	
CITATION P10	1.58 - 2.5	16 A	N & G	CPEYNBFN	10140	CPPYNBFN	12950	10A
CITATION P10	2.4 - 3.8	16 A	N & G	CPEYNBGN	10140	CPPYNBGN	12950	10A
CITATION P10	3.8 - 6	16 A	N & G	CPEYNBHN	10140	CPPYNBHN	12950	10A
CITATION P10	6 - 9.3	16 A	N & G	CPEYNBJN	10140	CPPYNBJN	13000	16A
CITATION P10	8.9 - 13.5	16 A	N & G	CPEYNBKN	10280	CPPYNBKN	13000	25A
CITATION P10	13.2 - 20	16 A	N & G	CPEYNBLN	10585	CPPYNBLN	13595	32A
CITATION P10B	13.2 - 20	20 A	N & G	CPEYNBL2N	10740	CPPYNBL2N	14010	40A
CITATION P10H	17.4 - 24	25 A	N & G	CPEYNBMN	11180	CPPYNBMN	14580	40A
CITATION P10H	23 - 32	25 A	N & G	CPEYNBPN	11935	CPPYNBPN	15350	50A
CITATION P11	23 - 32	32A	N & WB	CPEYNBP01N	12680	CPPYNBP01N	16305	63A
CITATION P11	26 - 40	32A	N & WB	CPEYNBQ01N	12855	CPPYNBQ01N	16460	63A
CITATION P12	26 - 40	40A	N & WB	CPEYNBQN	13810	CPPYNBQN	17085	63A

For spare contactor refer page 27

Citation P Submersible Pump Starter - Standard and Premium versions

STAR DELTA (3-Ph)

HSN CODE : 8536



Type	Overload Relay Range (A)	Contactor Rating (AC-3)	Coil	Standard (without Short Circuit Protection)		Premium (with Short Circuit Protection) with MCB/MCCB ^{New}		*MCB "C"10kA/ MCCB
				Cat. No.	MRP [₹]	Cat. No.	MRP [₹]	
CITATION P20	6 - 9.3	16 A	N & G	CPSDEYNBJN	20045	CPSPDPYNBUN	21900	32A
CITATION P20	8.9 - 13.5	16 A	N & G	CPSDEYNBKN	20045	CPSPDPYNBKN	22460	40A
CITATION P20	13 - 20	16 A	N & G	CPSDEYNBLN	20670	CPSPDPYNBLN	22625	50A
CITATION P20A	13.2 - 20	20 A	N, LV & G	CPSDEYNBL2N	21595	CPSPDPYNBL2N	24775	63A
CITATION P20A	17.4 - 24	20 A	N, LV & G	CPSDEYNBM2N	21610	CPSPDPYNBM2N	24910	63A
CITATION P20B	23 - 32A	25 A	N, LV & G	CPSDEYNBPN	25355	CPSPDPYNBPN	29875	63A
CITATION P20H	22 - 30A	32 A	N & WB	CPSDEYNB01NN	25955	CPSPDPYNB01NN	29975	63A
CITATION P20H	23 - 32A	32 A	N & WB	CPSDEYNB01PN	25970	CPSPDPYNB01PN	30560	63A
CITATION P20H	26 - 40A	32 A	N & WB	CPSDEYNB01QN	26745	CPSPDPYNB01QN	33200	80A/10kA
CITATION P21	26 - 40A	40 A	N & WB	CPSDEYNBQN	33725	CPSPDPYNBQN	41260	80A/10kA
CITATION P21	36 - 52A (FR OLR)	40 A	N & WB	CPSDEYNBFRGDN	39420	-	-	-

*Upto 63A MCB & 80A onwards MCCB are used

Range Extension



Type	Overload Relay Range (A) (Freedom OLR)	Contactor Rating (AC-3) (Citation 3P)	Cat. No.	Coil	MRP [₹] ^{New}
Citation P32	22 - 32	32 Amp	CPSDEYNBC4FRGBM	M	40140
Citation P40	36 - 52	40 Amp	CPSDEYNBDFRGDM	M	41190
Citation P50	45 - 63	50 Amp	CPSDEYNBD1FRGEM	M	49620
Citation P70	36 - 52	70 Amp	CPSDEYNBEFRGDM	M & LA	68255
Citation P70	45 - 63	70 Amp	CPSDEYNBEFRGEM	M & LA	70305
Citation P70	60 - 80	70 Amp	CPSDEYNBEFRGFM	M & LA	72695
Citation P100	60 - 80	110 Amp	CPSDEYNBM5FRGFM	M & LA	93150

For spare contactor refer page 27

Shakti P DOL Submersible Pump Starter (3-Phase)

HSN CODE : 8536



Type	Overload Relay Range (A)	Contactor Rating (AC-3)	Cat. No.	Coil	MRP [₹]
SHAKTI P6	1.58 - 2.5	12 A	CPEYSBFZ	Z & N & MB	9485
SHAKTI P6	2.4 - 3.8		CPEYSBGZ		
SHAKTI P6	3.8 - 6		CPEYSBHZ		
SHAKTI P6	6 - 9.3		CPEYSBJZ		
SHAKTI P10	8.9 - 13.5	20 A	CPEYSBKZ		9625
SHAKTI P10	13.2 - 20		CPEYSBLZ		10565
SHAKTI P10	17.4 - 24		CPEYSBMZ		11115

*For spare Contactor refer page 27

1-Phase DOL with 2P CPG Contactor & 2P Overload Relay

HSN CODE : 8536



Cat. No.	HP / KW at 1Ø, 220V, 50Hz	Overload Relay Range (A)	Contactor Type	Contactor Rating (AC-3)	MRP [₹]
NAAEBW-SP	-	1.07 - 1.70	2P CPG	12A	3555
NAAHBW-SP	0.75 / 0.55	3.8 - 6.0	2P CPG	12A	3555
NAHBW-SP	0.75 / 0.55	3.8 - 6.0	2P CPG	16A	3625
NAAJBW-SP	1 / 0.75	6.0 - 9.3	2P CPG	12A	3555
NAJBW-SP	1 / 0.75	6.0 - 9.3	2P CPG	16A	3625
NAKBW-SP	1.5 / 1.10	8.9 - 13.5	2P CPG	16A	3625
NAALBW-SP	2 / 1.5	13.2 - 20.0	2P CPG	20A	3720
NALBW-SP	2 / 1.5	13.2 - 20.0	2P CPG	25A	4055
NAMBW-SP	3 / 2.2	17.4 - 24.0	2P CPG	25A	4235

Auto Switch Cum SPP (SPP pro)



- Two type of versions : 6-wire and 7-wire
- Microcontroller based design for advanced functionality
- Protection against single phasing, reverse phasing and unbalance voltage
- Settable ON delay time - 5 Sec to 5 Min
- Integrated Auto/ Manual SPP/ Bypass switch
- LED indication :
 - Healthy Supply Conditions: Green LED is continuous ON
 - Unhealthy Supply Conditions: Green LED is blinking

HSN CODE : 8538

Cat. No.	Cat. No. (For BK Starters)	Description	MRP [₹]
BCHSPP2Z	BCHSPP2BKZ	SPP Pro (6 wire), 230-400V AC	1015
BCHSPP2N	BCHSPP2BKN	SPP Pro (6 wire), 380-415V AC	1015
BCHSPP2CW	BCHSPP2BKCW	SPP Pro (6 wire), 260-440V AC	1015
BCHSPP2Z-7W	BCHSPP2BKZ-7W	SPP Pro (7 wire), 230-400V AC	1015
BCHSPP2N-7W	BCHSPP2BKN-7W	SPP Pro (7 wire), 380-415V AC	1015
BCHSPP2CW-7W	BCHSPP2BKCW-7W	SPP Pro (7 wire), 260-440V AC	1015

1-Phase SPS With 2P Contactor + Overload Relay (Ammeter + Voltmeter) with 160-220V AC Coil

HSN CODE : 8536



HP at 1Ø, 220V, 50Hz	Overload Relay Range (A)	Contactor Rating (AC-3)	Cat. No.	Run Capacitor (mfd)	Start Capacitor (mfd)	MRP [₹]
0.75 HP	3.8 - 6.0	12 Amp	CPNSHBW-SPE	25	80/100	5865
0.75 HP	3.8 - 6.0	16 Amp	CPNSHBW-SP	25	80/100	5940
			CPNSHBW-SP(RC36)	36	80/100	5990
			CPNSHBW-RC25-SC120	25	100/120	6130
			CPNSHBW-RC30-SC200	30	150/200	6935
1 HP	6.0 - 9.3	12 Amp	CPNSJBW-SPE	36	100/120	6095
1 HP	6.0 - 9.3	16 Amp	CPNSJBW-SP	36	100/120	6135
			CPNSJBW-RC20SC100	20	80/100	6100
			CPNSJBW-RC25SC100	25	80/100	6185
			CPNSJBW-RC50SC100	50	80/100	6365
			CPNSJBW-RC60SC150	60	120/150	6660
			CPNSJBW-RC72SC150	72	120/150	6805
			CPNSJBW-SP(RC30)	30	100/120	6185
			CPNSJBW-SP(RC50)	50	100/120	6185
			CPNSJBW-SP(SC100)	36	80/100	6610
			CPNSJBW-RC36-SC200	36	150/200	7065
1.5 HP	8.9 - 13.5	12 Amp	CPNSKBW-SPE	50	120/150	6705
1.5 HP	8.9 - 13.5	16 Amp	CPNSKBW-SP	50	120/150	6695
			CPNSKBW-RC30SC120	30	100/120	6600
			CPNSKBW-RC36SC120	36	100/120	6620
			CPNSKBW-SP(RC36)	36	120/150	6660
			CPNSKBW-SP(RC72)	36+36	120/150	6870
CPNSKBW-RC50-SC200	50	150/200	7325			
2 HP	13.2 - 20.0	16 Amp	CPNSLBW-SP	72	150/200	7165
			CPNSLBW-SP(2RC36)	36+36	150/200	7345
			CPNSLBW-RC100SC150	100	120/150	7220
			CPNSLBW-RC90SC150	45+45	120/150	7355
			CPNSLBW-SP(SC150)	72	120/150	7355
CPNSLBW-RC72SC250	72	200/250	7760			
3 HP	17.4 - 24.0	20 Amp	CPNSMBW-SPE	100	200/250	7705
3 HP	17.4 - 24.0	25 Amp	CPNSMBW-SP	100	200/250	7965
			CPNSMBW-SP(2RC50)	50+50	200/250	8275
3 HP	22.0 - 30.0	25 Amp	CPNSNBW-SP	100	200/250	8520
			CPNSNBW-SP(2RC50)	50+50	200/250	8760
5 HP	23.0 - 32.0	32 A & 12 A	CPNSPBW-SPE	100+50	200/250	11855
5 HP	23.0 - 32.0	40 A & 16 A	CPNSPBW-SP	100+50	200/250	11930
			CPNSPBW-SP(3RC50)	50+50+50	200/250	12215
5 HP	23.0 - 32.0	40 Amp	New CPNSPBW-SPH	100+50	200/250	10230
			CPNSPBBW-SPH	100+50	200/250	10230
			CPNSPBW-SPH(3R50)	50+50+50	200/250	10230
			CPNSPBBW-SPH(3R50)	50+50+50	200/250	10230
5 HP	28.0 - 40.0	40 Amp	New CPNSQBBW-SPH	100+50	200/250	10750
			CPNSQBW-SPH	100+50	200/250	10750
			CPNSQBBW-SPH(3R50)	50+50+50	200/250	10750
			CPNSQBW-SPH(3R50)	50+50+50	200/250	10750

*Suffix "D" in Cat Code for Dry Run Protection panel (only Extra Terminal is provided to connect Dry Run unit)

**For 170-240V coil, replace "BW" in above cat code with "BBW"

1-Phase SPS (Alfa Model) With 2P Contactor + Overload Relay (Ammeter + Voltmeter)

HSN CODE : 8536

HP at 1Ø, 220V, 50Hz	Overload Relay Range (A)	Contactor Rating (AC-3)	Cat. No.	Run Capacitor (mfd)	Start Capacitor (mfd)	MRP [₹]
0.75 HP	3.8 - 6	16 Amp	CPGNSHBW-SP	25	80-100	5045
1 HP	6 - 9.3	16 Amp	CPGNSJBW-SP	36	100-120	5430
1 HP	6 - 9.3	16 Amp	CPGNSJBBW-SP	36	100-120	5430
1 HP	6 - 9.3	16 Amp	CPGNSJBW-SP(RC50)	50	100-120	5430
1 HP	6 - 9.3	16 Amp	CPGNSJBBW-SP(RC50)	50	100-120	5430
1 HP	6 - 9.3	16 Amp	CPGNSJBW-RC50SC100	50	80-100	5430
1.5 HP	8.9 - 13.5	16 Amp	CPGNKBBW-SP	50	120-150	5845
1.5 HP	8.9 - 13.5	16 Amp	CPGNKBBW-SP	50	120-150	5845
1.5 HP	8.9 - 13.5	16 Amp	CPGNKBBW-SP(RC72)	72	120-150	5845
1.5 HP	8.9 - 13.5	16 Amp	CPGNKBBW-SP(RC72)	72	120-150	5845
2 HP	13.2 - 20	16 Amp	CPGNLBBW-SP	72	150-200	6215
2 HP	13.2 - 20	16 Amp	CPGNLBBW-SP	72	150-200	6215
2 HP	13.2 - 20	16 Amp	CPGNLBBW-SP(2RC36)	36x2	150-200	6215
2 HP	13.2 - 20	16 Amp	CPGNLBBW-SP(2R36)	36x2	150-200	6215
2 HP	13.2 - 20	16 Amp	CPGNLBBW-RC90SC150	45X2	120-150	6215
2 HP	13.2 - 20	16 Amp	CPGNLBBW-R100SC150	100	120-150	6215
3 HP	17.4 - 24	25 Amp	CPGNMBBW-SP	100	200-250	6785
3 HP	17.4 - 24	25 Amp	CPGNMBBW-SP	100	200-250	6785
3 HP	17.4 - 24	25 Amp	CPGNMBBW-SP(2RC50)	50x2	200-250	6785
3 HP	17.4-24	25 Amp	CPGNMBBW-SP(2R50)	50x2	200-250	6785
3 HP	22 - 30	25 Amp	CPGNMNBW-SP(2RC50)	50x2	200-250	7125

New



1-Phase SPS With 2P Contactor + Overload Relay + Dry Run Protection

HSN CODE : 8536

HP at 1Ø, 220V, 50Hz	Overload Relay Range (A)	Contactor Rating (AC-3)	Cat. No.	Run Capacitor (mfd)	Start Capacitor (mfd)	MRP [₹]
0.75 HP	3.8 - 6	16 Amp	CPGND1HBW-SP	25	80-100	6085
1 HP	6 - 9.3	16 Amp	CPGND1JBW-SP	36	100-120	6290
1 HP	6 - 9.3	16 Amp	CPGND1JBBW-SP	36	100-120	6290
1 HP	6 - 9.3	16 Amp	CPGND1JBW-SP(RC50)	50	100-120	6335
1 HP	6 - 9.3	16 Amp	CPGND1JBW-R50S100	50	100-120	6520
1.5 HP	8.9 - 13.5	16 Amp	CPGND1KBW-SP	50	120-150	6860
1.5 HP	8.9 - 13.5	16 Amp	CPGND1KBBW-SP	50	120-150	6860
1.5 HP	8.9 - 13.5	16 Amp	CPGND1KBW-SP(RC72)	72	120-150	7035
2 HP	13.2 - 20	16 Amp	CPGND1LBW-SP	72	150-200	7340
2 HP	13.2 - 20	16 Amp	CPGND1LBBW-SP	72	150-200	7340
2 HP	13.2 - 20	16 Amp	CPGND1LBW-SP-2R36	36x2	150-200	7525
2 HP	13.2 - 20	16 Amp	CPGND1LBBW-SP-2R36	36x2	150-200	7525
2 HP	13.2 - 20	16 Amp	CPGND1LBW-R90S150	45X2	150-200	7535
2 HP	13.2 - 20	16 Amp	CPGND1LBW-R100S150	100	150-200	7400
3 HP	17.4 - 24	25 Amp	CPGND1MBW-SP	100	200-250	8160
3 HP	17.4 - 24	25 Amp	CPGND1MBBW-SP	100	200-250	8160
3 HP	17.4 - 24	25 Amp	CPGND1MBW-SP-2R50	50x2	200-250	8475
3 HP	17.4 - 24	25 Amp	CPGND1MBBW-SP-2R50	50x2	200-250	8475
3 HP	22 - 30	25 Amp	CPGND1NBW-SP-2R50	50x2	200-250	8970

New



1-Phase SPS with 2P DPC Contactor + MCB

HSN CODE : 8536

New



HP at 1Ø, 220V, 50Hz	SP MCB "C" Curve	Contactor Rating (AC-3)	Cat. No.	Run Capacitor (mfd)	Start Capacitor (mfd)	MRP [₹]
0.5 HP	6A	20A	CPD2A05CJ06	25	80-100	3815
0.75 HP	10A	20A	CPD2A07AK10	36	40-60	3815
1 HP	10A	20A	CPD2A10BM10	50	60-80	3840
1 HP	10A	20A	CPD2A10CK10	36	80-100	3840
1 HP	10A	20A	CPD2A10DK10	36	100-120	3870
1 HP	10A	20A	CPD2A10DM10	50	100-120	3920
1.5 HP	16A	20A	CPD2A15DL16	72	100-120	3985
1.5 HP	16A	20A	CPD2A15GM16	50	120-150	3985
1.5 HP	16A	20A	CPD2A15GL16	72	120-150	4055

Spares for 1-Phase Submersible Pump Starter (CPD)



Cat. No.	Description	MRP [₹]
SPA1A30V300	Digital VA Meter A1, AM30A, VM300V, S-72	705
SPA1VM-CT	CT for Digital VA Meter A1	140
SPARC	Off Push Button Red for 1Ph CPD SPS	275
SPAGC	On Push Button Green for 1Ph CPD SPS	335
SPATB530	Terminal Block 30A 5W for 1Ph CPD SPS	165
CPDN202KL	20A, 2P DP Contactor	1055
SP402MCKL	Coil 170-240V 2P DP Contactor (Bulk Pack of 12 nos.)	2735

1-Phase SPS With 2 Pole Contactor + Overload Relay (With Ammeter)

HSN CODE : 8536



Cat. No.	HP at 1Ø, 220V, 50Hz	Overload Relay Range (A)	Contactor Rating (AC-3)	Run Capacitor (mfd)	Start Capacitor (mfd)	MRP [₹]
CPNEHBW-SP	0.5 / 0.75 HP	3.8 - 6.0	16 Amp	25	80/100	5550
CPNEJBW-SP	1 HP	6.0 - 9.3	16 Amp	36	100/120	5855
CPNEKBW-SP	1.5 HP	8.9 - 13.5	16 Amp	50	120/150	6400
CPNELBW-SP	2 HP	13.2 - 20.0	16 Amp	36+36	150/200	6820
CPNEMBW-SP	3 HP	17.4 - 24.0	25 Amp	50+50	200/250	7775
CPNEPBW-SP	5 HP	23.0 - 32.0	40 Amp	50+50+50	200/250	11705

Suffix "D" in Cat Code for Dry Run Protection panel (only Extra Terminal is provided to connect Dry Run unit)

1-Phase SPS With Mini Manual DOL Starter (With Ammeter + Voltmeter)

HSN CODE : 8536



Cat. No.	HP at 1Ø, 220V, 50Hz	Overload Relay Range (A)	Run Capacitor (mfd)	MRP [₹]
CPPM50-25-SP	0.5 / 0.75HP	3.5 - 6.5	25	4260
CPPM50H-25-SP	0.5 / 0.75HP	3.5 - 6.5	25	4850
CPPM60-25-SP	1 HP	6.8 - 11	25	4290
CPPM60-36-SP	1 HP	6.8 - 11	36	4290
CPPM60H-36-SP	1 HP	6.8 - 11	36	4880
CPPM60-50-SP	1.5 HP	6.8 - 11	50	4515
CPPM60H-50-SP	1.5 HP	6.8 - 11	50	5130
CPPM70-36-SP	2 HP	11.0 - 20.0	36	4580
CPPM70-50-SP	2 HP	11.0 - 20.0	50	4580
CPPM70H-50-SP	2 HP	11.0 - 20.0	50	5215

DOL Starter - 3 Phase

HSN CODE : 8536

Cat. No.	Overload Relay Range (A)	HRC Fuse Rating (EE Type) (max)	MRP [₹]
OISWPGT	2.4 - 3.8	16A	4635
OISWPHT	3.8 - 6.0	20A	4635
OISWPJT	6.0 - 9.3	25A	4635
OISWPKT	8.9 - 13.5	36A	4635
OISWPLT	13.2 - 20.0	50A	4725
OISWPMT	17.4 - 24.0	63A	5115

Note : The last alphabet in the Cat No. indicates coil voltage : N-380-415VAC ; T-220-400VAC ; Y-240-400VAC

Star Delta Starter - Fully Automatic

HSN CODE : 8536

Cat. No.	Overload Relay Range (A)	HRC Fuse Rating (EE Type) (max)	MRP [₹]
OISDAWPJ*	6.0 - 9.3	20A	13740
OISDAWPK*	8.9 - 13.5	32A	13740
OISDAWPL*	13.2 - 20.0	35A	13740
OISDAWPM*	17.4 - 24.0	50A	14695
OISDAWPP*	23.0 - 32.0	63A	15385
OISDAWPQ*	26.0 - 40.0	80A	15680



Star Delta Starter - Semi Automatic

HSN CODE : 8536

Cat. No.	Overload Relay Range (A)	HRC Fuse Rating (EE Type) (max)	MRP [₹]
OISDSWPJ*	6.0 - 9.3	20A	12335
OISDSWPK*	8.9 - 13.5	32A	12335
OISDSWPL*	13.2 - 20.0	35A	12335
OISDSWPM*	17.4 - 24.0	50A	13265
OISDSWPP*	23.0 - 32.0	63A	13920
OISDSWPQ*	26.0 - 40.0	80A	14210

Star Delta Starter - Fully Automatic with Auto Unit SPP & 3 Position Auto Manual Switch

HSN CODE : 8536

Cat. No.	Overload Relay Range (A)	HRC Fuse Rating (EE Type) (max)	MRP [₹]
OISDYWPJ*	6.0 - 9.3	20A	16080
OISDYWPK*	8.9 - 13.5	32A	16080
OISDYWPL*	13.2 - 20.0	35A	16080
OISDYWPM*	17.4 - 24.0	50A	17100
OISDYWPP*	23.0 - 32.0	63A	17895
OISDYWPQ*	26.0 - 40.0	80A	18180

Star Delta Starter - Fully Automatic with Ammeter & Voltmeter

HSN CODE : 8536

Cat. No.	Overload Relay Range (A)	HRC Fuse Rating (EE Type) (max)	MRP [₹]
OISDPYWPL*	13.2 - 20.0	35 A	19770
OISDPYWPM*	17.4 - 24.0	50 A	20800
OISDPYWPP*	23.0 - 32.0	63 A	21750
OISDPYW PQ*	26.0 - 40.0	80 A	22045

'N' for 380-415VAC coil & 'Y' for 240-400VAC coil

Spares for Oil Starter

HSN CODE : 8538

Description			
Contact kit without coil for DOL - Power & Auxiliary contacts (set of fix contact, moving contact, hex screws, spring washer, spring clip, spring cap, contact spring)	OCK		600
Power kit without coil for all 3 contactor of star delta starter (fix contact, moving contact, hex screw, spring washer, spring clip, spring cap, contact spring)	Upto L Relay - OCKSD20		1480
	M, P Relay OCKSD30		1715
Auxiliary Contact Kit set for Star Delta Starter	Upto L Relay - OCKSDAUX20		395
	M, P Relay OCKSDAUX30		395
Coil -Main & Delta Contactor	220-400V	OCT	725
	240-400V	OCY	725
	380-415V	OCN	725
Coil -Star Contactor	220-400V	OCT-STAR	445
	240-400V	OCY-STAR	445
	380-415V	OCN-STAR	445
ON-Push Button		OPB-ON	190
OFF-Push Button		OPB-OFF	190
Incoming Mounting KIT for 20A		OCTKSD20	205
Incoming Mounting KIT for 30A		OCTKSD30	280

'NHD' Series 2 Pole Contactor

HSN CODE : 8536

AC# Rating at 240 V AC		Cat. No.	MRP [₹]
AC-1 (A)	AC-3 (A)		
20	12	CPG212*	1720
25	16	CPG216*	1960
35	20	CPG220*	2490
40	25	CPG225*	2915
40	32	CPG232*	3565
50	40	CPG240*	4240



'NHD' Series 4 Pole Contactor

HSN CODE : 8536

Size	AC1 (A)	AC3 Rating at 415 V AC			Cat. No.	MRP [₹]
		(A)	HP	KW		
CP12	20	12	7.5	5.5	CP12N*	3270
00	20	16	10	7.5	C00N*	3640
CP20	30	20	12.5	9.3	CP20N*	4490
0	32	25	15	11	N0N*	6610
01	40	32	20	15	N01N*	9355
1	50	40	25	18.5	N1N*	11890



HSN CODE : 8538

Auxiliary Contact Blocks - NHD/CPG	1 NO	001CB10	400
Auxiliary Contact Blocks - NHD/CPG	1 NO+1NC	001CB11	475
Auxiliary Contact Blocks - NHD/CPG	2NO	001CB20	475
Auxiliary Contact Blocks - NHD/CPG	2NC	001CB02	475

'NHD' Series 1 Aux + 3 P Contactor*

HSN CODE : 8536

Size	AC1 (A)	AC3 Rating at 415 V			Cat. No.	MRP [₹]
		(A)	HP	KW		
CA12	20	12	7.5	5.5	CA12N	2835
CA16	20	16	10	7.5	CA16N	3225
CA20	30	20	12.5	9.3	CA20N	3970
NA25	32	25	15	11	NA25N	5805
NA32	40	32	20	15	NA32N	8210
NA40	50	40	25	18.5	NA40N	10515



*Auxiliary contact is at left side in 1 Aux+ 3P Contactor

Citation Series 3 Pole Contactor

HSN CODE : 8536

Contactor Size	AC# Rating at 415 V		Cat. No.	MRP [₹]	Cat. No.	MRP [₹]
	AC-3 (A)	HP / KW				
C4	32	20 / 15	C4NE22M	8285	C4NE11M	7745
D	40	30 / 22	MC10DN22M	13110	MC10DN11M	11535
D1	50	33.5 / 25	MC10D1N22M	15420	MC10D1N11M	14510
D2	55	33.5 / 25	MC10D2N22M	16200	MC10D2N11M	15300
E	70	50 / 37	MC10EN22M	23465	MC10EN11M	22985
E1	75	50 / 37	MC10E1N22M	24500	MC10E1N11M	23975

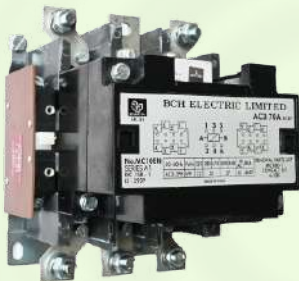

New

HSN CODE : 8536

Contactor Size	AC# Rating at 415 V			Aux. Contact	Cat. No.	MRP [₹]
	AC-1 (A)	AC-3 (A)	HP / KW			
M-5	150	110	80 / 60	1 NO + 1 NC	MCE15MN3M5	31965
N	300	140	100 / 75	1 NO + 1 NC	MCE15NN3M7	47665
S	315	300	220 / 160	1 NO + 1 NC	MCE15SN3M7	68890



Citation-M Overload Relays (Direct Mounting) with built in single phase protection

HSN CODE : 8536

HSN CODE : 8538



Cat. No.	Overload Relay Range (A)	MRP [₹]	Terminal Block for individual mounting	MRP [₹]
MC305ANA3A	0.195 - 0.31	2075	(Incoming) MC305TB1 (Outgoing) MC305TB3	305 305
MC305ANA3B	0.30 - 0.48	2075		
MC305ANA3C	0.47 - 0.75	2075		
MC305ANA3D	0.72 - 1.14	2075		
MC305ANA3E	1.07 - 1.70	2075		
MC305ANA3F	1.58 - 2.50	2075		
MC305ANA3G	2.40 - 3.80	2075		
MC305ANA3H	3.80 - 6.00	2075		
MC305ANA3J	6.00 - 9.30	2075		
MC305ANA3K	8.90 - 13.50	2075		
MC305ANA3L	13.20 - 20.0	2295	(Incoming) MC305TB2 (Outgoing) MC305TB3	305 305
MC305ANA3M	17.4 - 24.0	2535		
MC305ANA3N*	22.0 - 30.0	3270		
MC305ANA3P*	23.0 - 32.0	3300		
MC305ANA3Q*	26.0 - 40.0	3580		

*Overload relay type 'N', 'P' & 'Q' must be used with terminal block MC305TB3



CT Operated Overload Relays-Individual Mounting

HSN CODE : 8536

Cat. No.	Overload Relay Range (A)	MRP [₹]
CT1MC305ANA3C	24.4 - 39.0	6295
CT2MC305ANA3C	37.6 - 60.0	8125
CT3MC305ANA3C	56.4 - 90.0	9120
CT4MC305ANA3C	84.6 - 135.0	9260
CT5L1MC305ANA3C	112.8 - 180.0	14200
CT5MC305ANA3C	131.6 - 210.0	14665
CT6MC305ANA3C	188.0 - 300.0	16805
CT7MC305ANA3C	263.2 - 420.0	17370
CT8MC305ANA3C	376.0 - 600.0	20165



2 Pole Overload Relays (Direct Mounting)

HSN CODE : 8536

Cat. No.	Overload Relay Range (A)	MRP [₹]
MC307ANA2F	1.58 - 2.50	1065
MC307ANA2G	2.40 - 3.80	1065
MC307ANA2H	3.80 - 6.00	1065
MC307ANA2J	6.00 - 9.30	1065
MC307ANA2K	8.90 - 13.50	1065
MC307ANA2L	13.20 - 20.0	1230
MC307ANA2M	17.4 - 24.0	1315
MC307ANA2N	22 - 30	1530
MC307ANA2P	23 - 32	1560
New MC307ANA2Q	28 - 40	1730



WP Overload Relays for Shakti WP & Oil Starter

HSN CODE : 8536

Cat. No.	Overload Relay Range (A)	MRP [₹]
MC307ANA3J / MC307ANA3J-OS	6.00 - 9.30	1860
MC307ANA3K / MC307ANA3K-OS	8.90 - 13.50	1860
MC307ANA3L / MC307ANA3L-OS	13.20 - 20.0	2060
MC307ANA3M / MC307ANA3M-OS	17.4 - 24.0	2280
MC307ANA3N	22.0 - 30.0	2740
MC307ANA3P	23.0 - 32.0	2820

Spares for Shakti Starters

HSN CODE : 8538

Cat. No.	Description	MRP [₹]
SHB	Contact Kit 20A(1Aux+3P)**	On Request
SHAA	Contact Kit 12A (1 Aux + 3P)**	1030
SHZ	Coil 190- 400 V	515
SHCC	Contact carrier	115
SHPB	Extended Button Assembly	320
SHCO	Shakti Contactor for DOL 20A	3320
SHACO	Shakti Contactor for Star Delta 16A	3565
SHCOA	Shakti Contactor for DOL 12A	2810
NCPNYAU*-5S or 5M	SPP (for ASX & OISDY)-6 Wire	1015
CPTB630	Terminal Block 30A 6-way (Auto DOL)	340
CPAMS-3P/ASX	Auto Manual Switch 3-pos (Auto DOL)	585
SHA	Contact Kit*	1255

* Shakti Kit consist of - 8 Fixed main contacts, 4 moving main contacts, 4 springs & 4 retainers

** Shakti 1 Aux + 3P Kit consist of - 6 Fixed main contacts, 3 moving main contacts, 2 Aux main contacts, 1 Aux moving contact, 4 springs & 4 retainers

HSN CODE : 8538

Cat No.	Description	MRP[₹]
SPSRW8	Power Terminal Screw - 4P NHD Contactor	135
SPSRWSD4	Screw (4nos.) for Star Delta Starter	55
SPSRWDOL2	Screw (2nos.) for DOL Starter-Citation/Shakti	40
SPGR2	Gromet (2nos.) for DOL Starter-Citation/Shakti	30

Spares for 3-Phase Submersible Pump Starter

Cat. No.	Description	MRP [₹]
NCPYAU*-5S or 5M	SPP (3 Position SPS)-6 wire	1015
BCHSPP1*-5S or 5M	SPP (6-wire)	1015
BCHSPP2*	SPP Pro (6-wire)	1015
BCHSPP2BK*	SPP Pro for BK Starters (6-Wire)	1015
SPSATWB-30S	Electronic Timer (Star Delta)	1590
CPAM25	Ammeter 25A	680
CPAM50	Ammeter 50A	680
CPAM100	Ammeter 100A	715
CPVM500	Voltmeter 500V	680
CPTB215	Terminal Block 15A 2 way	90
CPTB360	Terminal Block 60A 3 way	260
CPTB660	Terminal Block 60A 6 way	425
CPTB3100	Terminal Block 100A 3 way	870
CPMB	Mounting Bracket Set	180
CPAMS-2P	Auto Manual Switch 2 position	445
CPAMS-3P	Auto Manual Switch 3 position	475
CPVSS	Voltmeter Selector Switch	480
HEA11GM-PB	Start PB (Green)	250
HEA11RM-PB	Stop PB (Red)	250
HCB10	Aux Block (1 NO)	140
HCB01	Aux Block (1 NC)	140
CPLED-R240	Incoming LED - RED	235
CPLED-Y240	Incoming LED - YELLOW	235
CPLED-B240	Incoming LED - BLUE	235

Spares for Citation M Starters

HSN CODE : 8538

Cat. No.	Description	MRP [₹]
SP100PB3	PB assembly for Citation Starters (Manufactured Before Apr'24)	385
SP100PBC1	PB assembly for Citation Starters (Manufactured from Apr'24 onwards)	385
SP100PBC2	PB assembly for Citation SASD	385
SP100CB	Start actuator Block for DOL	340
SP100CBS	Start actuator Block for SD	340
SP100TB	Terminal Block for Star Delta Starters	330
CPTB975	Terminal Block for SD Starters (40-50 HP)	1015
CPTB9150	Terminal Block 9 way 150Amp	1800
SPSATG	Electronic Timer (Star Delta)	1590
For 250-375 HP SD Starter		
TSFB-R	Push Button (RED)	355
TSFB-G	Push Button (Green)	355
050N1	Aux Contact Block(1NO+1NC)	485

Discontinued Cat Code	SPP Type	Alternate Cat Code	SPP used in
CPAU*	2-Pos SPP	NCPAU* - 5*	2-Pos SPS
CPYAU*	3-Pos SPP	NCPYAU* - 5*	3-Pos SPS
CPNYAU*	3-Pos SPP	NCPNYAU* - 5*	Oil SD & Auto DOL

*Extra plate to be used alongwith alternate SPP

Spares for 1-Phase Submersible Pump Starter

HSN CODE : 8538

Cat. No.	Description	MRP [₹]
ILR-B	"ON" Indication Lamp	95
SPAM-10	Ammeter 10A	680
SPAM-15	Ammeter 15A	680
SPAM-25	Ammeter 25A	680
SPAM-50	Ammeter 50A	680
SPVM-300	Voltmeter 300V	680
CPTB530	Terminal Block 30A 5 way (Mini Version)	170
CPTB530H	Terminal Block 30A 5 way (Contr. Version)	280
CPTB330	Terminal Block 30A 3 way	125
CPTB240	Terminal Block 40A 2 way	180
SPGC	"ON" Push Button for 1-Ph SPS (GREEN)	325
SPRC	"OFF" Push Button for 1-Ph SPS (RED)	265
MC305TB4	Outgoing Side Terminal Block for 23-32A relay	305

Spares for Freedom DOL

HSN CODE : 8538

Cat. No.	Description	MRP [₹]
C320SCB	Start Contact Block	230
CEPBI	Push Button - Green	115
CEPBO	Push Button - Red	115

KIT for NHD

HSN CODE : 8538

Contactor Rating (AC-3)	4P KIT	MRP [₹]	1 Aux + 3P KIT	MRP [₹]	1P KIT	MRP [₹]
	Cat Code		Cat. No.		Cat. No.	
12A	SP90E1	1185	SP90E2	1075	SP90E01	320
16A	SP90A1	1465	SP90A2	1340	SP90A01	395
20A	SP90F1	1975	SP90F2	1795	SP90F01	525
25A	SP90B1	2755	SP90B2	2505	SP90B01	705
32A	SP90D1	3935	SP90D2	3575	SP90D01	1020
40A	SP90C1	4830	SP90C2	4385	SP90C01	1235

* 4P Kit consist of - 8 Fixed main contacts, 4 moving main contacts, 4 springs & 4 retainers

* 1 Aux + 3P Kit consist of - 6 Fixed main contacts, 3 moving main contacts, 2 Aux main contacts, 1 Aux moving contact, 4 springs & 4 retainers

KIT for CPG

HSN CODE : 8538

Contactor Rating	Cat. No.	MRP [₹]
12A	CPG122PSP	660
16A	CPG162PSP	765
20A	CPG202PSP	1190
25A	CPG252PSP	1900
32A	CPG322PSP	1975
40A	CPG402PSP	2970

* 2P Kit consist of - 4 Fixed contacts, 2 moving contacts, 2 springs & 2 retainers

2P Contactor

HSN CODE : 8536 2P Contactor Kit

HSN CODE : 8538

Contactor Rating	Cat. No.	MRP [₹]	Rating	Cat. No.	MRP [₹]
16A	CPGN216*	1610	16A	CPGN162PSP	350
20A	CPGN220*	1815	20A	CPGN202PSP	380
25A	CPGN225*	2060	25A	CPGN252PSP	435

* 2P Kit consist of - 4 Fixed contacts, 2 moving contacts, 2 springs & 2 retainers



Spares for P series SPS

HSN CODE : 8538

Cat. No.	Description	MRP [₹]
CPRS-ON-OFF	ROCKER SWITCH ON-OFF	95
CPTB210	10A, 2 way TB for P series SPS	85
CPLIED-R	LED RED 415V	260
CPLIED-A	LED AMBER 415V	260
SP100CBP	Start Actuator block for P series SPS	340
CPAM10-WH, CPAM15-WH, CPAM25-WH, CPAM50-WH	Ammeter with White Bezel (for Shakti P SPS)	680
CPVM500-WH	Voltmeter 500V White Bezel	680

Spare Coil & Carrier

Contactor	Cat. No.	MRP [₹]
Magnet Coil for NHD/ CPG	SP90MC*	530
Carrier for NHD	SP90CC	125
Carrier for CPG	CPG2PCC	80

Spares for 1-ph Dry Run SPS

HSN CODE : 8538

Cat. No.	Description	MRP [₹]
SPDRPH0.75-S1	DRY RUN PROTECTOR S1, 3.8-6.0A, 0.75 HP	1135
SPDRPJ1-S1	DRY RUN PROTECTOR S1, 6.0-9.3A, 1 HP	1135
SPDRPK1.5-S1	DRY RUN PROTECTOR S1, 8.9-13.5A, 1.5 HP	1135
SPDRPL2-S1	DRY RUN PROTECTOR S1, 13.2-20A, 2 HP	1135
SPDRPM3-S1	DRY RUN PROTECTOR S1, 17.4-24A, 3 HP	1135
SPDRPN3-S1	DRY RUN PROTECTOR S1, 22-30A, 3 HP	1135
SPDRPP5-S1	DRY RUN PROTECTOR S1, 23-32A, 5HP	1135
SPDRP-CT-S1	CT FOR DRY RUN PROTECTOR S1	135
SPDRPCONNECTOR-S1	CONNECTOR FOR DRY RUN PROTECTOR S1	75

Dual Meter

HSN CODE : 9030

Cat. No.	MRP [₹]
CPAM10VM300, CPAM15VM300, CPAM25VM300, CPAM30VM300, CPAM50VM300	930
CPAM10VM500, CPAM15VM500, CPAM30VM500, CPAM60VM500	990
CPAM30-60VM500S72	965
CPAM60-120VM500S72	1040
CPAM30-60VM500S96	1230
CPAM60-120VM500S96	1375

Spare Freedom Overload Relays for Citation P32 to Citation P100

HSN CODE : 8536

Cat. No.	Overload Relay Range (A)	MRP [₹]
MC318GNA3B	22 - 32	3455
MC318GNA3C	29 - 42	3465
MC318GNA3D	36 - 52	4685
MC318GNA3E	45 - 63	5215
MC318GNA3F	60 - 80	6415

Adaptor for Individual mounting Cat Code- C318F2 (MRP Rs. 640)





COIL VOLTAGE : MASTER TABLE

	160-220V	170-240V	220-240V	230-360V	260-400V	310-400V	190-400V	230-420V	275-420V	380-415V	415V	440V	550V
	136-242V	145-264V	187-264V	196-396V	221-440V	264-440V	162-440V	196-462V	234-462V	323-456V	353-456V	374-484V	468-605V
PRODUCT	BW	BBW	H	-	-	-	-	-	-	N	-	-	-
WORKING VOLTAGE BAND	136-242V	145-264V	187-264V	196-396V	221-440V	264-440V	162-440V	196-462V	234-462V	323-456V	353-456V	374-484V	468-605V
C-PG 2P	BW	BBW	H	-	-	-	-	-	-	N	-	-	-
SHAKTI	BW	BBW	H	-	-	-	-	-	-	N	-	-	-
SHAKTI DOL	BW	BBW	H	-	-	-	Z	ZB	-	N	-	-	-
SHAKTI STAR DELTA	-	-	-	-	G	-	-	-	-	N	-	-	-
CP12, C00N, CP20	-	-	H	-	G	-	-	-	MB	N	-	C	D
N0N	-	-	H	LV	G	-	-	-	MB	N	-	-	D
N01N	-	-	H	LV	-	WB	-	-	-	N	-	C	-
N1N	-	-	H	-	-	WB	-	-	-	N	-	C	-
C4 & MC10D	-	-	-	-	-	-	-	-	-	-	M	C	D
MC10EN	-	-	-	-	-	-	-	-	-	-	M	C	D
MCE15L TO M5	-	-	-	-	-	-	-	-	-	-	M	C	D
MCE15N, Q & S	-	-	-	-	-	-	-	-	-	-	M	C	D

Also Available:

- * For N1N DL Coil (340-460V) option is available
- * For Citation E & M-5 (70A & 110A) LA Coil (320-400V) option is available
- * SP90MCMVN 415V (-35% - +10%) for NHD Contactor
- * 60Hz Coil 440V for NHD Contactor

MCB/Isolator/MCCB/Distribution Boxes



MCB - B CURVE

HSN Code : 8536

Rated Current	SP	DP	TP	FP
6 - 32A	285	1055	1660	2230
40A	695	1640	2520	3175
63A	705	1685	2585	3250

MCB - C CURVE

HSN Code : 8536

Rated Current	SP	SPN	DP	TP	TPN	FP
6 - 32A	285	1000	1055	1660	2135	2230
40A	695	1490	1640	2520	2890	3175
63A	705	1535	1685	2585	2955	3250

Order in multiple of SP-12 Nos., SPN-6 Nos., DP-6 Nos., TP-4 Nos., TPN-3 Nos., FP-3 Nos.

ISOLATORS

HSN Code : 8536

Poles	Standard Pack of	Rated Current	Cat. No.	MRP [₹]
2P	6 units	40A	BCHISODP40	715
	6 units	63A	BCHISODP63	880
3P	4 units	40A	BCHISOTP40	1270
	4 units	63A	BCHISOTP63	1455
4P	3 units	40A	BCHISOFP40	1490
	3 units	63A	BCHISOFP63	1615

MCCB

HSN Code : 8536

I _{cu} (Overload Setting)	Rated Current	Cat. No.	MRP [₹]
10kA @ (Fixed)	100, 80 (with spreader terminals)	XFE***P	3090
	100, 80 (without spreader terminals)	XFE***P-WT	2945
	63, 50, 40, 32, 25, 20, 16	XFE***P	2945

Code - Current Rating

Rating	16A	20A	25A	32A	40A	50A	63A	80A	100A
*Code	016	020	025	032	040	050	063	080	100

MCCB of any other rating can be offered on request, for more details please refer to Industrial product price list or contact sales team

MCB/MCCB Enclosure

HSN Code : 8537

Type	Product	Description	Cat. No.	MRP [₹]
MCB Enclosure	Enclosure only without MCB	SP, ONE WAY MCB DB	BCHOWMCBDBSP	745
		DP, ONE WAY MCB DB	BCHOWMCBDBDP	745
		TP, ONE WAY MCB DB	BCHOWMCBDBTP	805
		FP, ONE WAY MCB DB	BCHOWMCBDBFP	805
MCCB Enclosure	Enclosure only (without MCCB)	F1 MCCB Enclosure	F1EU3P	1395
		F2 MCCB Enclosure	F2EU3P	3020

HSN Code : 8536

Above MCB/MCCB with the enclosure serves as an ideal solution for main switch.

Complete range of BCH MCB Distribution Boxes are available.

For more details please refer to Comprehensive price list or contact sales team.

BCH Three Core Flat Cables with annealed bare & bunched copper conductor insulated & sheathed with PVC for submersible pump motors for voltage grade 1100 V as per I.S. 694 / 2010, conforming & marked with I.S. 694 / 2010 upto 95 sqmm. 3 Core Flat Cable PVC Insulated Type CS

HSN Code : 8544



BCH Code	Flat Cable	LP Per 500 Mtrs in [₹]	Remark
CS0010BM	1.0 Sqmm x 3 core Flat cable	On request	Also Available in 100 mtrs,500 mtrs 1000 mtrs in drum as well as in wrap packing
CS0015BM	1.5 Sqmm x 3 core Flat cable	On request	
CS0025BM	2.5 Sqmm x 3 core Flat cable	On request	
CS0040BM	4.0 Sqmm x 3 core Flat cable	On request	
CS0060BM	6.0 Sqmm x 3 core Flat cable	On request	
CS0080BM	8.0 Sqmm x 3 core Flat cable	On request	
CS0100BM	10 Sqmm x 3 core Flat cable	On request	
CS0160BM	16 Sqmm x 3 core Flat cable	On request	
CS0250BM	25 Sqmm x 3 core Flat cable	On request	
CS0350BM	35 Sqmm x 3 core Flat cable	On request	
CS0500BM	50 Sqmm x 3 core Flat cable	On request	
CS0700BM	70 Sqmm x 3 core Flat cable	On request	
CS0950BM	95 Sqmm x 3 core Flat cable	On request	
CS1200BM	120 Sqmm x 3 core Flat cable	On request	

BCH Three Core Flat Cables with XLPE insulation & ROHS PVC sheath for withstanding temperature upto 90 deg.C.

HSN Code : 8544



BCH Code	FLAT CS XLPE CABLE	LP Per 500 Mtrs in [₹]	Remark
CFTEX-03-0015BM	1.5 Sq. mm x 3 core Flat CS XLPE CABLE	On request	Also Available in 100 mtrs,500 mtrs 1000 mtrs in drum as well as in wrap packing
CFTEX-03-0025BM	2.5 Sq. mm x 3 core Flat CS XLPE CABLE	On request	
CFTEX-03-0040BM	4.0 Sq. mm x 3 core Flat CS XLPE CABLE	On request	
CFTEX-03-0060BM	6.0 Sq. mm x 3 core Flat CS XLPE CABLE	On request	
CFTEX-03-0080BM	8.0 Sq. mm x 3 core Flat CS XLPE CABLE	On request	
CFTEX-03-0100BM	10 Sq. mm x 3 core Flat CS XLPE CABLE	On request	
CFTEX-03-0160BM	16 Sq. mm x 3 core Flat CS XLPE CABLE	On request	
CFTEX-03-0250BM	25 Sq. mm x 3 core Flat CS XLPE CABLE	On request	
CFTEX-03-0350BM	35 Sq. mm x 3 core Flat CS XLPE CABLE	On request	
CFTEX-03-0500BM	50 Sq. mm x 3 core Flat CS XLPE CABLE	On request	

BCH Three Core Flat Cables with XLPE insulation & ROHS PVC sheath for withstanding temperature upto 90 deg.C.

HSN Code : 8544



BCH Code	Flat Cable	LP Per 500 Mtrs in [₹]	Remark
CFTX-03-0015BM	1.5 Sqmm x 3 core Flat cable XLPE insulated Thick	On request	Also Available in 100 mtrs,500 mtrs 1000 mtrs in drum as well as in wrap packing
CFTX-03-0025BM	2.5 Sqmm x 3 core Flat cable XLPE insulated Thick	On request	
CFTX-03-0040BM	4.0 Sqmm x 3 core Flat cable XLPE insulated Thick	On request	
CFTX-03-0060BM	6.0 Sqmm x 3 core Flat cable XLPE insulated Thick	On request	
CFTX-03-0080BM	8.0 Sqmm x 3 core Flat cable XLPE insulated Thick	On request	
CFTX-03-0100BM	10 Sqmm x 3 core Flat cable XLPE insulated Thick	On request	
CFTX-03-0160BM	16 Sqmm x 3 core Flat cable XLPE insulated Thick	On request	

BCH Three Core Flat Cables with XLPE insulation & ROHS PVC sheath for withstanding temperature upto 90 deg.C.

HSN Code : 8544



BCH Code	Flat Cable	LP Per 500 Mtrs in [₹]	Remark
CFXP-03-0015BM	1.5 Sqmm x 3 core Flat cable XLPE insulated	On request	Also Available in 100 mtrs,500 mtrs 1000 mtrs in drum as well as in wrap packing
CFXP-03-0025BM	2.5 Sqmm x 3 core Flat cable XLPE insulated	On request	
CFXP-03-0040BM	4.0 Sqmm x 3 core Flat cable XLPE insulated	On request	
CFXP-03-0060BM	6.0 Sqmm x 3 core Flat cable XLPE insulated	On request	

Note: At the end of every code "A" stand for 100 mtrs. , "BM" stand for 500 mtrs. , "CM" stand for 1000 mtrs. For price, please contact our nearest sales office.



BCH

Price List

General Terms & Conditions

Prices are subject to change without any prior notice and will be applicable as prevailing at the time of dispatch.

- The prices are ex-works basis..
- The prices given in this list are effective as on date and are subject to change without notice.
- Maximum Retail Price (MRP) mentioned are inclusive of GST.
- The List Prices (LP) mentioned are exclusive of GST.
- The duties, taxes and other statutory levies are based on rates prevailing at the time of billing. Any subsequent revision of those rates having retrospective effective shall be to customer's account.
- In case where any GST exemption has been claimed, the purchaser is responsible for providing the necessary GST exemption form within the specified period, failing which the purchaser would be liable for the payment of full GST plus applicable interest and penalties
- All Prices are in Indian Rupees (₹).
- Alteration made after receipt of confirmation of order are subject to price & delivery revisions and any other expenses or levies
- The dispute, if any, will be resolved mutually by discussion. However, if no settlement is forthcoming then, the Courts at New Delhi shall only have territorial jurisdiction to hear and decide the dispute.

Warranty

All products, unless specifically mentioned otherwise, shall have warranty, against manufacturing defects for a period of 18* months from the date of invoicing & 24 months from date of manufacturing whichever is later subject to the provision of proper usage and does not cover defects arising out of fire, accident, inefficient maintenance, faulty operation and willful or accidental damage. The manufacturer shall not be liable for any consequential loss, injury or damages attributable to defect or failure of its products.

* Proof of purchase to be retained to avail warranty.

- Power Control Products
- Starters & Submersible Pump Starters
- Industrial Enclosures
- Industrial Products
- Wires & Cables
- Motor Control Products
- Power Bus Duct
- Customised Solution
- Automation

a strong commitment to serve better always...



BCH ELECTRIC LIMITED



www.bchindia.com



1800-103-9262

customercare@bchindia.com

Visit us at : www.bchindia.com

Registered & Corporate Office : 1105, New Delhi House, 27, Barakhamba Road, New Delhi - 110 001 Tel. : 91-11- 43673100

CIN : U31103DL1965PLC425953, **Customercare No.** 1800-103-9262, **E-mail :** marketing@bchindia.com

Works 1 : 20/4, Mathura Road, Faridabad - 121 006 (Haryana) Tel. : 0129-4063000/4293000 Fax : 0129-2304016

Works 2 : 64-68, Sector-7, IIE, Pant Nagar, Rudrapur, Udham Singh Nagar - 263 153 (Uttarakhand) Tel. : 05944-250214/16 Fax : 05944-250215

Sales Offices :

Ahmedabad
401, Shilp Zeveri,
Beside Shyamal Iconic,
Above Westside,
Shyamal Cross Road,
Ahmedabad - 380015
E-mail: ahmedabad@bchindia.com

Bangalore
2nd Floor, 130/5,
K.H. Road (Double road),
Bangalore - 560 027
Tel.: 080-41144879 / 22236759
E-mail: bangalore@bchindia.com

Bhubaneswar
Mallick Commercial
Complex Plot No.: A/69, unit - 3
Bhubaneswar - 751 001
Tel.: 0674-2380988
E-mail: bhubaneswar@bchindia.com

Chandigarh (Panchkula)
SCO -270, 2nd Floor,
Sector-16, Panchkula
Haryana-134 113
Tel.: 0172-5078957 / 5049905
E-mail: chandigarh@bchindia.com

Chennai
Flat No. 3A, 3rd Floor,
Sree Apartments,
No.508, TTK Road,
Alwarpet, Chennai 600 018
Tel.: 044-24337046, 24337047
E-mail: chennai@bchindia.com

Coimbatore
87, Dr. Nanjappa Road,
Coimbatore - 641 018
Tel. : 0422-2305311 / 2302599
E-mail: coimbatore@bchindia.com

Delhi 1
801, Akash Deep Building,
26A, Barakhamba Road,
New Delhi - 110 001
Tel. : 011-23313878 / 43518200
E-mail: delhi@bchindia.com

Delhi 2
710, Deepali Building, 92
Nehru Place, New Delhi - 110
019 Tel. : 011-45720334
E-mail: delhi2@bchindia.com

Dehradun
8, Co-operative Industrial Estate,
Patel Nagar, Dehradun-248001
E-mail: dehradun@bchindia.com

Faridabad
20/4, Mathura Road,
Faridabad - 121 006 (Haryana)
Telfax : 0129-4293009
E-mail: faridabad@bchindia.com

Hyderabad
1-8-30348/13/102, Arya One,
2nd Floor, P. G. Road,
Secunderabad - 500 003
Tel. : 040-66206263/27890306
Fax : 040-66207273
E-mail: hyderabad@bchindia.com

Indore
330-331, Indraprastha Tower,
3rd Floor, 6, M.G. Road,
Indore - 452 001
Tel. : 0731-2510011 / 2510012
E-mail: indore@bchindia.com

Jaipur
25, Hathroi, Gopalbari,
Jaipur - 302 001
Tel. : 0141-2363521
E-mail: jaipur@bchindia.com

Jamshedpur
A.J. Tower, 2B,
2nd Floor, R-Road, Bistupur,
Jamshedpur - 831 001
E-mail: jamshedpur@bchindia.com

Kolkata
Block 1E, 216,
Acharya Jagadish Chandra Bose
Road, Kolkata - 700 017
Tel. : 033-22871728 / 46021884
E-mail: kolkata@bchindia.com

Lucknow
Shop No. 3, First Floor,
Tower T-10, Millennium Place IBB - 2,
Sushant Golf City, Sultanpur Road,
Lucknow U.P. - 226030
Tel. : 0522-4025597/4025997
E-mail: lucknow@bchindia.com

Ludhiana
S.C.O.-18, 2nd Floor,
Feroze Gandhi Market,
Ludhiana - 140 001
Tel. : 0161-5021807/5022808
E-mail: ludhiana@bchindia.com

Madurai
12, Parvathi Plaza-3rd Floor,
70 Feet Road, Ellis Nagar
Madurai-625016, Tamilnadu
Email: madurai@bchindia.com

Mumbai
A-151, Mittal Tower,
Nariman Point,
Mumbai - 400 021
Tel. : 022-22822947/22850162
Fax : 022-22822858
E-mail: mumbai@bchindia.com

Patna
No.703, 7th Floor, Luv Kush
Tower, Exhibition Road,
Patna - 800001

Pune
8, Sarosh Bhavan,
16-B/1, Dr. Ambedkar Road,
Pune - 411 001
Tel. : 020-41210002
E-mail: pune@bchindia.com

Raipur
6th Floor, Office No. 607,
Babylon Capital, Near Oswal
Petrol Pump, VIP Chowk,
G.E. Road, Raipur - 492 006
Tel. : 0771- 4045053
E-mail: raipur@bchindia.com

Vadodara
301, Third Floor, "Florence Classic",
10, Ashapuri Co-Op. Hsg. Soc. Ltd., Opp. VUDA
Housing, Near Cow Circle, Akota, Vadodara - 390 020
Tel. : 0265-2345068/2345069
Telefax: 0265-2345068,
E-mail: vadodara@bchindia.com

Other Branch Locations

Cochin : cochin@bchindia.com, **Guwahati :** guwahati@bchindia.com, **Vishakapatnam :** vizag@bchindia.com, **Surat :** surat@bchindia.com, **Trichy :** Trichy@bchindia.com

Resident Engineer Locations

Agra	Bhopal	Hospet	Kanpur	Muzaffarnagar	Rajahmundry	Silliguri	Varanasi
Ahmednagar	Calicut	Hubli	Karimnagar	Nanded	Ranchi	Solapur	Vijaywada
Ambala	Goa	Idukki	Karnal	Nashik	Rourkela	Srinagar	Vishakapatnam
Anantapur	Gulbarga	Jabalpur	Kota	Panipat	Rudarpur	Trivendrum	Vellore
Ankleshwar	Gurgaon	Jalandhar	Kurnool	Patna	Salem	Tirunelveli	Vilupuram
Aurangabad	Haridwar	Jodhpur	Midnapore	Puducherry	Sikar	Udaipur	Warangal
Bhiwadi	Hisar	Kashipur	Mahua	Rajkot	Silchar	Vapi	Yamunanagar



BCH
ELECTRIC
LIMITED



ENCLOSURES

Price List effective 17th November 2025

Modern facilities at Faridabad & Rudrapur



Our Strengths

- ◆ State-of-the-art product development and R&D
- ◆ Modern manufacturing facilities
- ◆ Tool room with latest facilities
- ◆ Serving customers for five decades
- ◆ Presence in ~50 locations
- ◆ 650 channel partners
- ◆ ISO 9001:2015 & ISO 14001:2015, ISO 45001: 2018 certified company

Core Values

- ◆ Integrity
- ◆ Nurturing People
- ◆ Commitment to Customers
- ◆ Striving for Excellence
- ◆ Long Term Thinking

Quality Policy

We as a member of BCH Electric Limited manufacturer of Low Voltage Switchgear & Controlgear products, are fully committed to provide Quality products and service in compliance with applicable Statutory and Regulatory requirements, to meet or exceed the customer need and expectations through -

- ◆ Continual improvement
- ◆ Involvement of employees
- ◆ Setting Quality objectives
- ◆ Training and development of employees

Health & Safety Policy

We as a member of BCH Electric Limited manufacturer of Low Voltage Switchgear & Controlgear products, are fully committed to conduct Business in compliance to applicable Health & Safety legislation and regulation.

We shall continually improve through -

- ◆ Provide Safe & Healthy working conditions for the prevention of work related injury and ill health.
- ◆ Develop & maintain the Health & Safety objectives & targets and conduct health & safety programs for achieving the objectives and target.
- ◆ The prevention of accidents through the identification, assessment and elimination of workplace hazards and the promotion of health & safety awareness among its employees and contractors.
- ◆ Encourage employee's participation and consultation in matters affecting the health, safety and well being of our people and seek suggestions from our employees of ways in which health, safety & well being can be furthered.

The Health & safety policy is publicly available on request.

Environmental Policy

We as a member of BCH Electric Limited manufacturer of Low Voltage Switchgear & Controlgear products, are fully committed to conduct Business in compliance to applicable Environmental legislation and regulation.

We shall continually improve through -

- ◆ Provide a framework for setting and reviewing environmental objectives and targets.
- ◆ Regularly review the impact of our activities on environment and strive to reduce the pollution/waste.
- ◆ Involve employees in our environmental program and provide necessary training to enable them to discharge their responsibilities towards environment management.
- ◆ Sustain the program of continual improvement in environment in environmental performance incorporating suitable metrics and monitoring.

The Environment policy is publicly available on request.

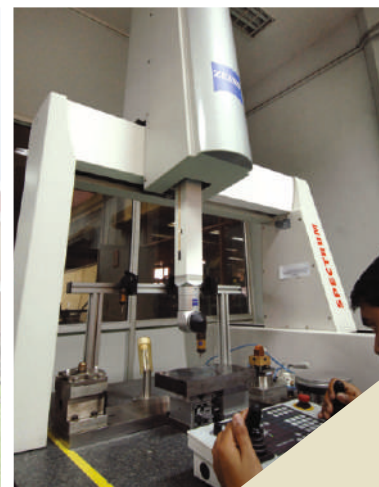

www.bchindia.com

Enclosure Systems

- **Bhartia Enclosure 2.0**
- **Terminal Box 2.0**
- **'BCH-SS' (Stainless Steel) Boxes**
- **Terminal Boxes**
- **Bhartia Boxes**
- **TCE Series Enclosure**
- **Techno - Modular Enclosures**
- **Compartmentalized Enclosure (Fixed & Draw-out)**
- **Control Desk**
- **IT Racks - 19" and ETSI Racks**
- **Non Metallic Enclosure**





- Available in 45 different variants
- Single/Double door version
- Min. Size : 200Wx300Hx150D mm
- Max. Size : 1200Wx1400Hx400D mm
- Degree of protection
 - IP66 - IK10 for Single door enclosure
 - IP55 - IK10 for Double door enclosure
- CE Certified



Bhartia Enclosure 2.0

HSN CODE: 8538

Type	SIZE (WxHxD) mm	MOQ Nos.	Cat No.	List Price [₹]
SINGLE DOOR ENCLOSURE	200X300X120	1	BIL-40000	3660
SINGLE DOOR ENCLOSURE	200X300X150	1	BIL-40010	3990
SINGLE DOOR ENCLOSURE	250X300X150	1	BIL-40020	4140
SINGLE DOOR ENCLOSURE	300X300X150	1	BIL-40030	4460
SINGLE DOOR ENCLOSURE	300X300X210	1	BIL-40040	4755
SINGLE DOOR ENCLOSURE	300X400X150	1	BIL-40050	4960
SINGLE DOOR ENCLOSURE	300X400X210	1	BIL-40060	5560
SINGLE DOOR ENCLOSURE	400X300X150	1	BIL-40070	4860
SINGLE DOOR ENCLOSURE	400X300X210	1	BIL-40080	5450
SINGLE DOOR ENCLOSURE	400X400X150	1	BIL-40090	5560
SINGLE DOOR ENCLOSURE	400X400X210	1	BIL-40100	5895
SINGLE DOOR ENCLOSURE	400X500X150	1	BIL-40110	6280
SINGLE DOOR ENCLOSURE	400X500X210	1	BIL-40120	6655
SINGLE DOOR ENCLOSURE	400X600X210	1	BIL-40140	7845
SINGLE DOOR ENCLOSURE	400X600X350	1	BIL-40150	9730
SINGLE DOOR ENCLOSURE	500X500X210	1	BIL-40160	7845
SINGLE DOOR ENCLOSURE	500X500X300	1	BIL-40170	9410
SINGLE DOOR ENCLOSURE	500X600X210	1	BIL-40180	9000
SINGLE DOOR ENCLOSURE	500X700X210	1	BIL-40190	10230
SINGLE DOOR ENCLOSURE	500X700X300	1	BIL-40200	11770
SINGLE DOOR ENCLOSURE	600X400X210	1	BIL-40210	7995
SINGLE DOOR ENCLOSURE	600X400X300	1	BIL-40220	10275
SINGLE DOOR ENCLOSURE	600X600X210	1	BIL-40230	9650
SINGLE DOOR ENCLOSURE	600X600X300	1	BIL-40240	11590
SINGLE DOOR ENCLOSURE	600X600X350	1	BIL-40250	12295
SINGLE DOOR ENCLOSURE	600X800X210	1	BIL-40260	11650
SINGLE DOOR ENCLOSURE	600X800X250	1	BIL-40270	13365
SINGLE DOOR ENCLOSURE	600X800X300	1	BIL-40280	13335
SINGLE DOOR ENCLOSURE	600X1000X210	1	BIL-40290	14690
SINGLE DOOR ENCLOSURE	600X1000X300	1	BIL-40300	16665
SINGLE DOOR ENCLOSURE	600X1200X300	1	BIL-40310	19135
SINGLE DOOR ENCLOSURE	800X600X300	1	BIL-40320	13255
SINGLE DOOR ENCLOSURE	800X800X210	1	BIL-40330	14645
SINGLE DOOR ENCLOSURE	800X800X300	1	BIL-40340	15550
SINGLE DOOR ENCLOSURE	800X1000X250	1	BIL-40350	17675
SINGLE DOOR ENCLOSURE	800X1000X300	1	BIL-40360	17885
SINGLE DOOR ENCLOSURE	800X1200X300	1	BIL-40370	22280
DOUBLE DOOR ENCLOSURE	1000X800X210	1	BIL-40380	18690
DOUBLE DOOR ENCLOSURE	1000X800X300	1	BIL-40390	21430
DOUBLE DOOR ENCLOSURE	1000X1000X300	1	BIL-40400	24925
DOUBLE DOOR ENCLOSURE	1000X1200X300	1	BIL-40410	28645
DOUBLE DOOR ENCLOSURE	1000X1400X300	1	BIL-40420	34265
DOUBLE DOOR ENCLOSURE	1000X1400X400	1	BIL-40430	38095
DOUBLE DOOR ENCLOSURE	1200X1400X300	1	BIL-40440	36125
DOUBLE DOOR ENCLOSURE	1200X1400X400	1	BIL-40450	39760

MOQ : Minimum order quantity in nos.

Technical Particulars (Bhartia Enclosure 2.0)

- Enclosure body fabricated from 1.2mm/1.6mm
- Enclosure door fabricated from 1.2mm/1.6mm/2.0mm
- Cable entry plate 1.6mm provided at bottom
- Mounting plate made 2.0/2.5mm Galvanised steel
- Foamed in PU Gasket
- Hinged door interchangeable LHS/RHS
- Door opening angle 120°
- Die casted Cam lock provided up to 1000mm height
- 3 - point lock provide for 1200mm and above height
- Powder coated to RAL - 7035 structure finish

Note: Cutout charges will be extra

: Wall mounting bracket set is an additional accessory
(For Bhartia enclosure 2.0 and Terminal Box 2.0 it not a part of standard packing)

HSN CODE: 8538

Type	Cat No.	MOQ Nos.	List Price [₹]
Set of Wall Mounting Bracket (small)	BIL-WM-S	1	205
Set of Wall Mounting Bracket (big)	BIL-WM-B	1	235
Wall Mounting Bracket Kit 20mm	BIL-WM-H20	1	350

Note :

- * Set of wall mounting bracket (small) is suitable for all range of terminal boxes 2.0 and Bhartia Enclosure 2.0 upto size : 400x500x200mm.
- * Set of wall mounting bracket (big) is suitable for Bhartia Enclosure 2.0 beyond size : 400x500x200mm.

*List Prices are Ex-works Faridabad. For detail refer Enclosure Selling Terms & Conditions.
*GST to be charged extra





- Available in 22 different variants
- Min. Size : 150Wx150Hx80D mm
- Max. Size : 600Wx400Hx120D mm
- Degree of protection: IP66 - IK10
- CE Certified



Terminal Box 2.0

HSN CODE: 8538

SIZE (W x H x D) mm	MOQ	Cat No.	List Price [₹]
150X150X80	1	BIL-30000	1785
200X150X80	1	BIL-30010	1970
300X150X80	1	BIL-30020	2275
200X200X80	1	BIL-30030	2070
300X200X80	1	BIL-30040	2210
400X200X80	1	BIL-30050	2365
600X200X80	1	BIL-30060	3210
150X150X120	1	BIL-30070	2035
200X150X120	1	BIL-30080	2105
300X150X120	1	BIL-30090	2320
400X150X120	1	BIL-30100	2730
200X200X120	1	BIL-30110	2275
300X200X120	1	BIL-30120	2520
400X200X120	1	BIL-30130	2865
500X200X120	1	BIL-30140	3590
600X200X120	1	BIL-30150	3970
300X300X120	1	BIL-30160	3055
400X300X120	1	BIL-30170	3660
500X300X120	1	BIL-30180	3950
600X300X120	1	BIL-30190	4775
400X400X120	1	BIL-30200	4140
600X400X120	1	BIL-30210	5200

MOQ : Minimum order quantity in nos.

Technical Particulars (Terminal Box 2.0)

- Enclosure body fabricated from 1.2mm
- Enclosure door fabricated from 1.2mm
- Holes with rubber grommet at top and bottom of enclosure body provided to facilitate cable entry
- Provision of din rail fixing in horizontal position on predrilled bracket
- Door removable type with quick release fasteners
- Foamed in PU Gasket
- Powder coated to RAL - 7035 structure finish

Note: Cutout charges will be extra

*List Prices are Ex-works Faridabad. For detail refer Enclosure Selling Terms & Conditions.

***GST to be charged extra**



- Fabricated from 1.2/1.5 mm stainless steel sheet
- Mounting Plate made up of 2.0mm Galvanised steel
- Cable entry plate 2.0mm SS 304 provided at bottom
- SS grade 304
- Foamed - in PU gasket
- Box upto BIL - 90405020 is made up of 1.2 mm SS & above of 1.5 MM SS.
- Degree of protection IP66
- 120 deg door open-able concealed hinge door with cam locking arrangement.



- 43 Different Versions
- Min. Size : 150 X 150 X 80
- Max Size : 800 X 400 X 120
- Degree of protection IP55/IP66/IK10
- CE Certified

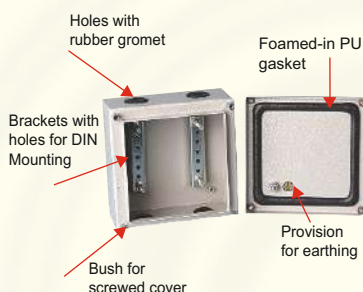

Technical Particulars (TERMINAL BOXES)

- Fabricated from 1.2mm CRCA sheet steel
- Powder coated to shade RAL 7035
- Structure finish
- Foamed-in PU gasket
- Provided with screwed cover on top
- Degree of protection IP55/IP66/IK10
- CE Certified
- Brackets provided inside to facilitate DIN rail mounting
- Holes with Gromet provided to facilitate cable entry in IP 55 terminal boxes

Note: Cutout charges will be extra

'BCH - SS' (Stainless Steel)

HSN Code : 8538

Type	Size (WxHxD) mm	MOQ Nos.	Cat No.	List Price [₹]
SINGLE DOOR BOX	200X300X150	3	BIL-90203015	7765
SINGLE DOOR BOX	300X300X200	3	BIL-90303020	10755
SINGLE DOOR BOX	400X400X200	3	BIL-90404020	14230
SINGLE DOOR BOX	400X500X200	3	BIL-90405020	15850
SINGLE DOOR BOX	400X600X200	3	BIL-90406020	18165
SINGLE DOOR BOX	500X600X200	3	BIL-90506020	23265
SINGLE DOOR BOX	600X600X200	3	BIL-90606020	24880
SINGLE DOOR BOX	600X800X200	3	BIL-90608020	29575
SINGLE DOOR BOX	500X700X300	3	BIL-90507030	30040
SINGLE DOOR BOX	800X800X300	3	BIL-90808030	41360

MOQ - Minimum order quantity in nos.

Type	Cat No.	MOQ Nos.	List Price [₹]
SET OF SS WALL MOUNTING BRACKET (SMALL)	BIL-WM-S-SS	1	600
SET OF SS WALL MOUNTING BRACKET (BIG)	BIL-WM-B-SS	1	800

Terminal Boxes

HSN Code : 8538

Box Size (W x H x D)	IP-55 Range			IP-66 Range	
	MOQ	Cat. No.	List Price [₹]	Cat. No.	List Price [₹]
150x150x80	5	BIL-70000	1680	BIL-80000	1735
200x150x80	-			BIL-80100	1910
300x150x80	5	BIL-70010	1975	BIL-80010	2205
200x200x80	5	BIL-70020	1890	BIL-80020	2010
300x200x80	5	BIL-70030	2070	BIL-80030	2150
400x200x80	-			BIL-80110	2295
600x200x80	-			BIL-80130	3125
150x150x120	5	BIL-70040	1860	BIL-80040	1975
200x150x120	-			BIL-80150	2050
300x150x120	5	BIL-70050	2205	BIL-80050	2245
200x200x120	5	BIL-70060	2150	BIL-80060	2205
300x200x120	5	BIL-70070	2395	BIL-80070	2445
400x200x120	5	BIL-70080	2685	BIL-80080	2775
300x300x120	5	BIL-70090	2860	BIL-80090	2965
400x150x120	-			BIL-80170	2650
400x300x120	5	BIL-70180	3165	BIL-80180	3555
400x400x120	5	BIL-70190	3720	BIL-80190	4020
500x200x120	5	BIL-70200	3260	BIL-80200	3485
500x300x120	5	BIL-70210	3620	BIL-80210	3835
600x200x120	5	BIL-70220	3645	BIL-80220	3845
600x300x120	5	BIL-70230	4455	BIL-80230	4640
600x400x120	5	BIL-70240	4890	BIL-80240	5050
800x200x120	5	BIL-70250	5155	BIL-80250	5320
800x400x120	5	BIL-70260	6270	BIL-80260	6390

MOQ-Minimum order quantity in nos.

*List Prices are Ex-works Faridabad. For detail refer Enclosure Selling Terms & Conditions.

*GST to be charged extra

Bhartia Boxes

HSN Code : 8538



- 51 Different Versions
- Single/Double door versions
- Min. Size : 200 X 200 X 150
- Max Size : 1200 X 1400 X 400
- Degree of protection IP55/IP66/IK10
- CE Certified

Double door version

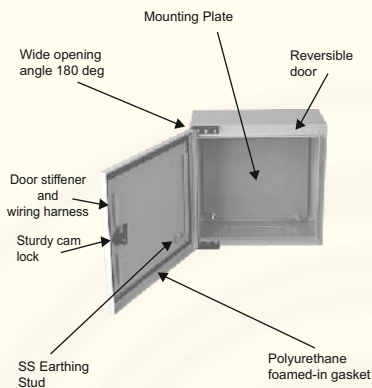

Technical Particulars (BHARTIA BOXES)

- Fabricated from 1.2mm / 1.6mm CRCA sheet steel (Sizes upto BIL-50180 made from 1.2mm CRCA, beyond this using 1.6mm CRCA)
- Foamed-in PU gasket
- Hinged door, interchangeable LHS / RHS, opening angle 180 deg for standard hinge & 120 deg for concealed hinge in bigger sizes.
- Degree of protection IP55/IP66/IK10
- CE Certified
- Cable gland plate 2mm thick provided at bottom
- Cam locking arrangement
- Powder coated to RAL : 7035 structure finish
- Mounting Plate made up of 2.0mm Galvanised steel

Note : Cutout charges will be extra

Wall mounting bracket set is an additional accessory (for Bhartia Box & Terminal box it is not a part of standard packing)

HSN Code : 8538

Type	Cat. No.	MOQ	List Price [₹]
Set of Wall Mounting bracket (small)	BIL-WM-S	1	205
Set of Wall Mounting bracket (big)	BIL-WM-B	1	235
Set of Wall Mounting bracket Kit 20mm	BIL-WM-H20	1	350

Note :

- * Set of wall mounting bracket (small) is suitable for all range of terminal boxes and Bhartia boxes upto size : 400x500x200mm.
- * Set of wall mounting bracket (big) is suitable for Bhartia boxes beyond size : 400x500x200mm.

Type	Size (WxHxD) mm	IP-55 Range			IP-66 Range	
		Nos.	Cat. No.	List Price [₹]	Cat. No.	List Price [₹]
SINGLE DOOR BOX	200x200x150	1	BIL-50000	3380	BIL-60000	3555
SINGLE DOOR BOX	200x300x150	1	BIL-50010	3870	BIL-60010	3945
SINGLE DOOR BOX	250x300x150	1	BIL-50020	4020	BIL-60020	4145
SINGLE DOOR BOX	300x300x150	1	BIL-50030	4335	BIL-60030	4505
SINGLE DOOR BOX	300x300x200	1	BIL-50050	4620	BIL-60050	4890
SINGLE DOOR BOX	300x400x150	1	BIL-50060	4815	BIL-60060	5070
SINGLE DOOR BOX	300x400x200	1	BIL-50080	5405	BIL-60080	5435
SINGLE DOOR BOX	400x300x150	1	BIL-50090	4720	BIL-60090	5000
SINGLE DOOR BOX	400x300x200	1	BIL-50110	5290	BIL-60110	5370
SINGLE DOOR BOX	400x400x150	1	BIL-50120	5405	BIL-60120	5505
SINGLE DOOR BOX	400x400x200	1	BIL-50140	5725	BIL-60140	5900
SINGLE DOOR BOX	400x500x150	1	BIL-50150	6095	BIL-60150	6415
SINGLE DOOR BOX	400x500x200	1	BIL-50170	6460	BIL-60170	6645
SINGLE DOOR BOX	500x500x200	1	BIL-50180	7615		
SINGLE DOOR BOX	400x600x200	1	BIL-50190	7615	BIL-60190	7725
SINGLE DOOR BOX	500x600x200	1	BIL-50210	8735	BIL-60210	9000
SINGLE DOOR BOX	500x700x200	1	BIL-50220	9930		
SINGLE DOOR BOX	500x700x300	1	BIL-50230	11425		
SINGLE DOOR BOX	600x400x200	1	BIL-50240	7760	BIL-60240	8050
SINGLE DOOR BOX	600x400x300	1	BIL-50250	9975		
SINGLE DOOR BOX	600x500x200	1	BIL-50260	9000	BIL-60260	9725
SINGLE DOOR BOX	600x600x200	1	BIL-50270	9365		
SINGLE DOOR BOX	600x600x300	1	BIL-50280	11255		
SINGLE DOOR BOX	600x700x200	1	BIL-50290	11280		
SINGLE DOOR BOX	600x800x200	1	BIL-50300	11310		
SINGLE DOOR BOX	600x800x300	1	BIL-50320	12945		
SINGLE DOOR BOX	600x1000x200	1	BIL-50330	14265		
SINGLE DOOR BOX	600x1000x300	1	BIL-50340	16185		
SINGLE DOOR BOX	800x800x300	1	BIL-50310	15100		
SINGLE DOOR BOX	800x1000x200	1	BIL-50350	16810		
SINGLE DOOR BOX	800x1000x250	1	BIL-50360	17160		
SINGLE DOOR BOX	800x1000x300	1	BIL-50390	17365		
SINGLE DOOR BOX	800x1200x300	1	BIL-50395	21635		
DOUBLE DOOR BOX	1000x800x200	1	BIL-50500	18145		
DOUBLE DOOR BOX	1000x800x300	1	BIL-50520	20805		
DOUBLE DOOR BOX	1000x1000x300	1	BIL-50540	24195		
DOUBLE DOOR BOX	1000x1200x300	1	BIL-50550	27815		
DOUBLE DOOR BOX	1000x1400x300	1	BIL-50560	33265		
DOUBLE DOOR BOX	1200x1400x300	1	BIL-50570	36980		
DOUBLE DOOR BOX	1000x1400x400	1	BIL-50580	35080		
DOUBLE DOOR BOX	1200x1400x400	1	BIL-50590	38605		

MOQ. Minimum order quantity in nos.

Canopy for Bhartia Boxes

HSN Code : 8538

Size (WxHxD) mm	Cat. No.	MOQ Nos.	List Price [₹]	Size (WxHxD) mm	Cat. No.	MOQ Nos.	List Price [₹]
200WX150D	BIL-12-CAN-2015	1	890	600WX200D	BIL-16-CAN-6020	1	1705
250WX150D	BIL-12-CAN-2515	1	1010	600WX300D	BIL-16-CAN-6030	1	2090
300WX150D	BIL-12-CAN-3015	1	1080	800WX300D	BIL-16-CAN-8030	1	2545
300WX200D	BIL-12-CAN-3020	1	1175	800WX200D	BIL-16-CAN-8020	1	2070
400WX150D	BIL-12-CAN-4015	1	1225	800WX250D	BIL-16-CAN-8025	1	2230
400WX200D	BIL-12-CAN-4020	1	1350	1000WX200D	BIL-16-CAN-1020	1	2425
500WX200D	BIL-12-CAN-5020	1	1530	1000WX300D	BIL-16-CAN-1030	1	2985
500WX300D	BIL-12-CAN-5030	1	1875				

*List Prices are Ex-works Faridabad. For detail refer Enclosure Selling Terms & Conditions.

*GST to be charged extra

TCE Series Enclosure Code Selection |

Example:-

TCE	06	18	05	-	001
	↓	↓	↓		↓
TCE Series of Enclosure	Width	Height	Depth		Version

Sizes Available |

Width	Height	Depth
06-600 W	18-1800 H	04-400 D
08-800 W	20-2000 H	05-500 D
10-1000 W	22-2200 H	06-600 D
12-1200 W		08-800 D

Version Details |

001	002	003	004	005
Structure:	Structure:	Structure:	Structure:	Structure:
Front Door with Hinge	Front Door with Hinge	Front Door with Hinge	Front Door with Hinge	Front Door with Hinge
Rear Bolted Cover	Rear Door with Hinge	Rear Bolted Cover	Rear Door with Hinge	Rear Door with Hinge
STD Gland Plate	STD Gland Plate	STD Gland Plate	STD Gland Plate	STD Gland Plate
Top Cover	Top Cover	Top Cover	Top Cover	Top Cover
Eye Bolt	Eye Bolt	Eye Bolt	Eye Bolt	Eye Bolt
01 Mounting Plate	01 Mounting Plate	No Mounting Plate	No Mounting Plate	2 Mounting Plate

*List Prices are Ex-works Faridabad. For detail refer Enclosure Selling Terms & Conditions.
*GST to be charged extra

Technical Particulars for TCE Series

- IP66-IK10 for single door enclosure
- IP65-IK10 for double door enclosure
- Structure made up with 2.0mm CRCA
- Door made up with 2.0mm CRCA and covers made up with 1.6mm CRCA
- Bottom 3-part cable entry provision as standard and made up with 2.0mm GPSP
- Mounting plate with sliding arrangement and made up with 3.0mm GPSP
- Push fit Die casted hinge provided at doors.
- Door with Interchangeability features (LHS/RHS)
- 4-point locking provides as standards
- Separate locking at LHS door with swing handle
- Door stiffener with provision of drilling holes for wiring harness.
- Eye bolt as standard for lifting
- Modular Plinth (optional) 100mm Height with Black finish
- Side Covers – Pair consisting of 1no. LHS and 1no. RHS cover
- Surface finish to enclosure RAL-7035



Note: up to 800 mm width single door
1000 mm & 1200 mm width double door

IK10

IP66 | IP65

C E



*List Prices are Ex-works Faridabad. For detail refer Enclosure Selling Terms & Conditions.
*GST to be charged extra

HSN Code: 8538

Size of Enclosure in mm			Cat No.	Enclosure Version*				
Width (W)	Height (H)	Depth (D)		VER-001 LP [₹]	VER-002 LP [₹]	VER-003 LP [₹]	VER-004 LP [₹]	VER-005 LP [₹]
600	1800	400	TCE061804	35075	39070	27855	32165	
800	1800	400	TCE081804	41895	45975	31850	36825	
1000	1800	400	TCE101804	57665	62145	44725	48910	
1200	1800	400	TCE121804	64805	72380	50270	55725	
600	1800	500	TCE061805	36645	40335	29730	33410	
800	1800	500	TCE081805	42665	48035	34100	38190	
1000	1800	500	TCE101805	59220	63730	46655	51440	
1200	1800	500	TCE121805	66035	75025	52895	59430	
800	1800	600	TCE081806	45490	47730	37020	40530	55460
800	1800	800	TCE081808	47470	52225	39485	44225	63355
600	2000	400	TCE062004	37800	42500	29030	34485	
800	2000	400	TCE082004	44005	48315	33620	38170	
1000	2000	400	TCE102004	63010	66540	49000	52405	
1200	2000	400	TCE122004	67690	74815	54165	61395	
600	2000	500	TCE062005	40120	43450	32935	37220	
800	2000	500	TCE082005	45015	49685	34685	39545	
1000	2000	500	TCE102005	62345	69760	49685	55130	
1200	2000	500	TCE122005	68170	75025	53590	59430	
600	2000	600	TCE062006	40715	44725	34875	38880	53815
800	2000	600	TCE082006	46570	50745	37395	41585	60230
1000	2000	600	TCE102006	63335	72665	50445	58815	88110
1200	2000	600	TCE122006	69515	77070	56300	63515	93570
600	2000	800	TCE062008	41895	45015	34990	39360	58630
800	2000	800	TCE082008	48510	52105	39645	43415	63450
1000	2000	800	TCE102008	69515	74125	53590	59430	86575
1200	2000	800	TCE122008	73075	81055	60030	66035	96700
600	2200	600	TCE062206	45890	50270	36430	43245	60230
800	2200	600	TCE082206	51930	55335	41805	46085	64580
1000	2200	600	TCE102206	71900	77440	59080	64620	90510
1200	2200	600	TCE122206	74710	83400	58065	64875	103730
600	2200	800	TCE062208	50035	54275	38390	44320	57760
800	2200	800	TCE082208	60395	63915	46370	50445	69875
1000	2200	800	TCE102208	76570	82500	62145	66840	96140
1200	2200	800	TCE122208	82815	87485	67815	72380	108425

*List Prices are Ex-works Faridabad. For detail refer Enclosure Selling Terms & Conditions.

***GST to be charged extra**



TCE Bottom Plinth 100mm Height

HSN Code: 8538

Size in MM		Cat No	LP [₹]
Width (W)	Depth (D)		
600	400	TCEPL0604	3160
800	400	TCEPL0804	3605
1000	400	TCEPL1004	4035
1200	400	TCEPL1204	4420
600	500	TCEPL0605	3380
800	500	TCEPL0805	3795
1000	500	TCEPL1005	4235
1200	500	TCEPL1205	4615
600	600	TCEPL0606	3575
800	600	TCEPL0806	3975
1000	600	TCEPL1006	4385
1200	600	TCEPL1206	4785
600	800	TCEPL0608	3975
800	800	TCEPL0808	4385
1000	800	TCEPL1008	4745
1200	800	TCEPL1208	5210



TCE Side Panel

HSN Code: 8538

Size in MM		Cat No	LP [₹]
Height (H)	Depth (D)		
1800	400	TCESP0418	6300
1800	500	TCESP0518	7315
1800	600	TCESP0618	8140
1800	800	TCESP0818	10850
2000	400	TCESP0420	6765
2000	500	TCESP0520	7960
2000	600	TCESP0620	8840
2000	800	TCESP0820	11380
2200	600	TCESP0622	10240
2200	800	TCESP0822	13310

MOQ-Minimum order quantity in nos.

Note: Cutout charges will be extra

Freight charges will be extra at actuals

*List Prices are Ex-works Faridabad. For detail refer Enclosure Selling Terms & Conditions.

***GST to be charged extra**

TCE Series Enclosure Accessories

Baying system

HSN Code: 8538

Sl. No	Description	Cat No	LP [₹]
1	Baying Kit	TCE-14280	2340
2	Combination Angle (Pack of 2)	TCE-14281	1230

Mounting plate filler profile

HSN Code: 8538

Sl. No	Description	Cat No	LP [₹]
1	Filler plate for 1800mm Height	TCE-FP-1800	1780
2	Filler plate for 2000mm Height	TCE-FP-2000	1960
3	Filler plate for 2200mm Height	TCE-FP-2200	2150

Wiring plan pocket

HSN Code: 8538

Sl. No	Description	Cat No	LP [₹]
1	File pocket 500mm Width	TCE-TPKT-500	870
2	File pocket 600mm Width	TCE-TPKT-600	1040
3	File pocket 800mm Width	TCE-TPKT-800	1350

Lamp rail

HSN Code: 8538

Sl. No	Description	Cat No	LP [₹]
1	Lamp rail 600mm Width	TCE-LAMP-RAIL-600	250
2	Lamp rail 800mm Width	TCE-LAMP-RAIL-800	340
3	Lamp rail 1000mm Width	TCE-LAMP-RAIL-1000	420
4	Lamp rail 1200mm Width	TCE-LAMP-RAIL-1200	510

Limit switch with fixing arrangement

HSN Code: 8538

Sl. No	Description	Cat No	LP [₹]
1	BCH Limit switch	TCE-LC	1040

Punched section for depth

HSN Code: 8538

Sl. No	Description	Cat No	LP [₹]
1	Punched section 400mm depth	TCE-PSD-400	615
2	Punched section 500mm depth	TCE-PSD-500	870
3	Punched section 600mm depth	TCE-PSD-600	1110
4	Punched section 800mm depth	TCE-PSD-800	1480

Punched section for width

HSN Code: 8538

Sl. No	Description	Cat No	LP [₹]
1	Punched section 600mm width	TCE-PSW-600	1230
2	Punched section 800mm width	TCE-PSW-800	1480
3	Punched section 1000mm width	TCE-PSW-1000	1725
4	Punched section 1200mm width	TCE-PSW-1200	1960

Air Filter Unit

HSN Code: 8538

Sl. No	Description	Cat No	LP [₹]
1	Snap fit air filter 148x148	BIL-SF-1414	965
2	Snap fit air filter 204x204	BIL-SF-2020	1450
3	Snap fit air filter 255x255	BIL-SF-2525	1605
4	Snap fit air filter 204x204 with mounting adaptor	BIL-SFMA-2020	1690
5	Snap fit air filter 255x255 with mounting adaptor	BIL-SFMA-2525	2120

Door Stay

HSN Code: 8538

Sl. No	Description	Cat No	LP [₹]
1	Door Stay for TCE Series	TCE-DS	1340

Techno Modular Enclosures

HSN Code : 8538

Size of Enclosure (W x H x D in mm)	Cat. No.	Enclosure Version*				Plinth		Side Covers (Pair)	
		Ver 001 LP[₹]	Ver 002 LP[₹]	Ver 003 LP[₹]	Ver 004 LP[₹]	Cat. No.	List Price [₹]	Cat. No.	List Price [₹]
600 x 1800 x 400	TME 061804	32740	36465	26000	30015	TPL 061804	3180	TSC 061804	6345
800 x 1800 x 400	TME 081804	39110	42915	29735	34370	TPL 081804	3620	TSC 081804	6345
1000 x 1800 x 400	TME 101804	53825	58010	41740	45660	TPL 101804	4060	TSC 101804	6345
1200 x 1800 x 400	TME 121804	60470	67555	46925	52010	TPL 121804	4455	TSC 121804	6345
600 x 1800 x 500	TME 061805	34195	37650	27745	31185	TPL 061805	3405	TSC 061805	7370
800 x 1800 x 500	TME 081805	39820	44835	31835	35645	TPL 081805	3835	TSC 081805	7370
1000 x 1800 x 500	TME 101805	55290	59470	43560	48025	TPL 101805	4270	TSC 101805	7370
1200 x 1800 x 500	TME 121805	61640	70030	49370	55475	TPL 121805	4645	TSC 121805	7370
800 x 1800 x 600	TME 081806	42455	44570	34565	37825	TPL 081806	4005	TSC 081806	8195
600 x 2000 x 400	TME 062004	35290	39650	27100	32205	TPL 062004	3180	TSC 062004	6825
800 x 2000 x 400	TME 082004	41065	45105	31380	35625	TPL 082004	3620	TSC 082004	6825
1000 x 2000 x 400	TME 102004	58825	62100	45740	48910	TPL 102004	4060	TSC 102004	6825
1200 x 2000 x 400	TME 122004	63195	69840	50560	57295	TPL 122004	4455	TSC 122004	6825
600 x 2000 x 500	TME 062005	37460	40555	30735	34740	TPL 062005	3405	TSC 062005	8010
800 x 2000 x 500	TME 082005	42020	46385	32380	36925	TPL 082005	3835	TSC 082005	8010
1000 x 2000 x 500	TME 102005	58195	65115	46385	51465	TPL 102005	4270	TSC 102005	8010
1200 x 2000 x 500	TME 122005	63635	70030	50010	55475	TPL 122005	4645	TSC 122005	8010
600 x 2000 x 600	TME 062006	38000	41740	32555	36295	TPL 062006	3590	TSC 062006	8915
800 x 2000 x 600	TME 082006	43470	47375	34910	38825	TPL 082006	4005	TSC 082006	8915
1000 x 2000 x 600	TME 102006	59110	67825	47100	54910	TPL 102006	4430	TSC 102006	8915
1200 x 2000 x 600	TME 122006	64885	71930	52540	59285	TPL 122006	4840	TSC 122006	8915
600 x 2000 x 800	TME 062008	39110	42020	32650	36725	TPL 062008	4005	TSC 062008	11460
800 x 2000 x 800	TME 082008	45280	48650	37005	40525	TPL 082008	4430	TSC 082008	11460
1000 x 2000 x 800	TME 102008	64885	69200	50010	55475	TPL 102008	4775	TSC 102008	11460
1200 x 2000 x 800	TME 122008	68210	75640	56030	61640	TPL 122008	5265	TSC 122008	11460
600 x 2200 x 600	TME 062206	42830	46925	34020	40365	TPL 062206	3590	TSC 062206	10325
800 x 2200 x 600	TME 082206	48475	51655	39005	43010	TPL 082206	4005	TSC 082206	10325
1000 x 2200 x 600	TME 102206	67110	72280	55140	60320	TPL 102206	4430	TSC 102206	10325
1200 x 2200 x 600	TME 122206	69735	77840	54205	60560	TPL 122206	4840	TSC 122206	10325
600 x 2200 x 800	TME 062208	46710	50665	35835	41380	TPL 062208	4005	TSC 062208	13410
800 x 2200 x 800	TME 082208	56375	59660	43305	47100	TPL 082208	4430	TSC 082208	13410
1000 x 2200 x 800	TME 102208	71460	77000	58010	62385	TPL 102208	4775	TSC 102208	13410
1200 x 2200 x 800	TME 122208	77295	81645	63290	67555	TPL 122208	5265	TSC 122208	13410

*Baying kit (BIL-14280) Rs. 2150/- is also available for Enclosure Version. For extra accessories, please contact nearest branch office.

MOQ-Minimum order quantity in nos.

Note : Cutout charges will be extra

Freight charges will be extra at actuals

*List Prices are Ex-works Faridabad. For detail refer Enclosure Selling Terms & Conditions.

***GST to be charged extra**

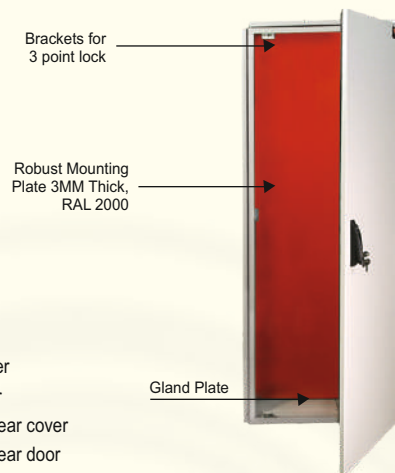

Modular Enclosures

- Enclosures
- Minimum size in mm :
600 x 1800 x 400 (W x H x D)
- Maximum size in mm :
1200 x 2200 x 800 (W x H x D)
- Degree of protection IP55/IK10
- CE Certified
- Wide range of accessories

Features

- Completely modular in all the three axis
- Powder coated surface (RAL 7035) for excellent finish and durability
- PU Gasket ensuring higher degree of ingress protection
- 3mm mounting plate as a standard
- Manufactured on CNC Turret punch press for higher precision, finish and repeated accuracy
- Ideal for :
 - Special purpose machines
 - Control panels
 - Drives
 - Starter enclosures
 - Accessories for mounting 19" equipment

Enclosure Versions

- 001 - with mounting plate and rear cover
- 002 - with mounting plate and rear door
- 003 - without mounting plate and with rear cover
- 004 - without mounting plate and with rear door

To Order And Calculate List Price

- (a) Choose Cat. No. and LP of Enclosure version from 001, 002, 003 or 004
- (b) Add Cat. No. and LP of Plinth
- (c) Add Cat. No. and LP of Side Covers pair

General Technical Particulars

- Degree of protection IP55/IK10
- CE Certified
- Fabricated from 2/1.6 mm CRCA/GPSP (frame made up of 2.0mm GPSP, doors & covers made up of 1.6 mm CRCA).
- Fully bolted construction
- Mounting Plate with sliding arrangement - standard & Powder coated to RAL-2000
- Modular Plinth (optional) 100mm high fabricated from CRCA
- Cable entry provision is given from Bottom & made in 3-part construction with Galvanized steel [Unpainted]
- Foamed-in PU gasket
- Powder coated to RAL : 7035 structure finish
- Hinge design allows 120 deg. Door opening
- 3 point lock provided as standard
- Door stiffener with provision of drilling holes for wiring harness.
- Side Covers - Pair : consisting of 1no. LHS and 1no. RHS cover
- To calculate limiting dimension of the enclosure, add 44mm to the width to account for Side Covers, 22mm to the height for Top Cover & 44mm to the depth on account of Front and Rear door / cover.

Note : upto 800 mm width single door
1000 mm & 1200 mm width double leaf door

*List Prices are Ex-works Faridabad. For detail refer Enclosure Selling Terms & Conditions.

***GST to be charged extra**
www.bchindia.com

Highlights of **BCH** Compartmentalized **MCC / PCC / PMCC** Solution (Fixed & Drawed Type)



- 100% Modular Structure; can be dispatched in flat pack.
- Flexible compartmentalized -up to From 4.
- IP 54 degree of protection with polyurethane foam gasket.
- Compartment size available from 200mm height & multiplies of 100mm.
- Additional accessories like Cable support, Busbar support, Limit Switch and Lamp brackets are available.
- Adjustable mounting plates (Depth wise at the pitch of 25mm).
- Panel can be expended in all 3 dimensions and bayed together by using Baying Kit.
- All Structure members (Corner & Cross bar) having M6 extrude hole at 25mm intervals, No need of any Captive hardware.
- Standard Module dimension for Drawout Enclosures.
 - ▷ Single Front :- 900(W) x 2400(H) x 600(D)
 - ▷ Double Front :- 900(W) x 2400(H) x 1200(D)
- Draw-out feeder available from 200mm height (2SU) to 800mm height (8SU).
- Colours :- RAL-7035 (Structure finish) for structure, doors, covers & internal parts RAL-2000 (smooth finish) for Mounting plates, Ral-9000 (Smooth Finish) for Plinth.
- Sheet thickness 2.0mm GPSP for structure, 2.0mm CRCA for Mounting Plate & Mounting rail, 1.6mm CRCA for Doors & Covers, 1.2mm CRCA for Separation plates.

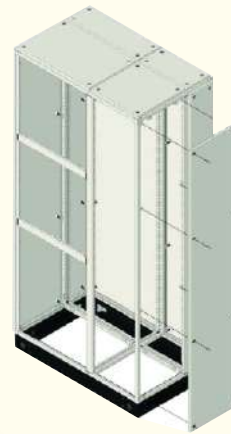

Technical Particulars (CONTROL DESK):

- Desk body: 1.6mm CRCA sheet
- Hinged door: 1.6mm CRCA sheet
- Bottom Gland plate: 2.0mm CRCA sheet
- Mounting plate: 2.0mm GPSP sheet
- Plinth corner: 2.0mm CRCA sheet
- Plinth Trim Plates: 1.6mm CRCA sheet
- Foamed-in PU gasket at front door
- Powder coated to RAL: 7035 structure finish
- Bottom plinth painted with smooth black color
- Mounting plate Zn galvanized



Control Desk

HSN Code : 8538

Type	SIZE (WxHxD) mm	Control DESK		
		MOQ Nos.	Cat No.	List Price [₹]
SINGLE DOOR CONTROL DESK	600X1000X400	3	BIL-CD-061004	19750
SINGLE DOOR CONTROL DESK	800X1000X400	3	BIL-CD-081004	23500
SINGLE DOOR CONTROL DESK	600X1000X500	3	BIL-CD-061005	21500
SINGLE DOOR CONTROL DESK	800X1000X500	3	BIL-CD-081005	26000
DOUBLE DOOR CONTROL DESK	1000X1000X400	3	BIL-CD-101004	27500
DOUBLE DOOR CONTROL DESK	1200X1000X400	3	BIL-CD-121004	32000
DOUBLE DOOR CONTROL DESK	1000X1000X500	3	BIL-CD-101005	31400
DOUBLE DOOR CONTROL DESK	1200X1000X500	3	BIL-CD-121005	35500

Bottom Plinth for Control Desk

HSN Code : 8538

Size in MM		MOQ Nos.	Cat No	List Price [₹]
Width (W)	Depth (D)			
600	400	3	BIL-CDPL-0604	3250
800	400	3	BIL-CDPL-0804	3700
1000	400	3	BIL-CDPL-1004	4150
1200	400	3	BIL-CDPL-1204	4550
600	500	3	BIL-CDPL-0605	3500
800	500	3	BIL-CDPL-0805	3950
1000	500	3	BIL-CDPL-1005	4400
1200	500	3	BIL-CDPL-1205	4800



Key Attributes:

- Aesthetic & robust construction
- Mounting Fan /s in top doesn't take usable "U" space.
- Special type of Wallmounting hardware.
- Provision for earthing available in the cabinets.
- Highly corrosion resistant in nature.
- Power coated to shade RAL : 7035 structure finish.



Key Attributes:

- Floor mounting robust design.
- Lockable & removable side panels.
- 2-pairs of adjustable 19" rails.
- Front door with toughened glass & perforation.
- High load bearing capacity.
- Rear vented door.
- Provision for fan mounting in top which doesn't take usable "U" Space.
- Superior cable management facility in extra wide racks.
- 4-integrated vertical cable managers are default design of 800mm wide racks.
- Rear space saving split door with 3-point secure locking in extra wide (800mm) racks.
- Power coated to shade RAL : 7035 structure finish.

19" Wall Mount Racks

HSN Code : 8538

Dimensions (H x W x D) mm	MOQ Nos.	Cat. No.	List Price [₹]
6UX550X400	1	BIL-W-6-5504	6065
9UX550X400	1	BIL-W-9-5504	7315
6UX550X500	1	BIL-W-6-5505	6695
9UX550X500	1	BIL-W-9-5505	7805
12UX550X500	1	BIL-W-12-5505	8670
15UX550X500	1	BIL-W-15-5505	10205

MOQ-Minimum order quantity in nos.

Standard Configuration: Wallmount cabinet, 2-Pairs of 19" rail.

Notes : Accessories viz. Shelves, Fans, power strips, cable managers captive H/W & wall mounting hardware etc. will be extra as per the accessories list furnished in the price list.
Wall mount racks price do not include freight & will be extra at actuals

19" Networking Racks

HSN Code : 8538

Dimensions (H x W x D) mm	MOQ Nos.	Cat. No.	List Price [₹]
24U X 600 X 600	1	BIL-N-062406	33915
24U X 600 X 800	1	BIL-N-062408	37495
24U X 800 X 600	1	BIL-N-082406	42500
24U X 800 X 800	1	BIL-N-082408	46445
30U X 600 X 600	1	BIL-N-063006	37495
30U X 600 X 800	1	BIL-N-063008	41085
30U X 800 X 600	1	BIL-N-083006	46445
30U X 800 X 800	1	BIL-N-083008	50910
36U X 600 X 600	1	BIL-N-063606	41085
36U X 600 X 800	1	BIL-N-063608	45540
36U X 800 X 600	1	BIL-N-083606	50930
36U X 800 X 800	1	BIL-N-083608	55295
42U X 600 X 600	1	BIL-N-064206	47345
42U X 600 X 800	1	BIL-N-064208	50730
42U X 800 X 600	1	BIL-N-084206	55725
42U X 800 X 800	1	BIL-N-084208	61605
45U X 600 X 600	1	BIL-N-064506	54475
45U X 600 X 800	1	BIL-N-064508	57175
45U X 800 X 600	1	BIL-N-084506	59825
45U X 800 X 800	1	BIL-N-084508	65185

MOQ-Minimum order quantity in nos.

Notes : 1) Networking racks price do not include freight & this will be extra at actuals.

For more details visit : www.bchindia.com/technorack

*List Prices are Ex-works Faridabad. For detail refer Enclosure Selling Terms & Conditions.

***GST to be charged extra**

19" Server Racks

HSN Code : 8538

Key Attributes:

- Floor mounting robust design.
- Lockable & removable side panels.
- 2-pairs of adjustable 19" rails.
- Front door with toughened glass & perforation.
- High load bearing capacity.
- Rear vented door.
- Provision for fan mounting in top which doesn't take usable "U" Space.
- Superior cable management facility in extra wide racks.
- 4-integrated vertical cable managers are default design of 800mm wide racks.
- Rear space saving split door with 3-point secure locking
- locking in extra wide (800mm) racks.
- Power coated to shade RAL : 7035 structure finish.

Dimensions (H x W x D) mm	MOQ Nos.	Cat. No.	List Price [₹]
24U X 600 X 900	1	BIL-S-062409	38315
24U X 600 X 1000	1	BIL-S-062410	40715
30U X 600 X 900	1	BIL-S-063009	43325
30U X 600 X 1000	1	BIL-S-063010	45015
36U X 600 X 900	1	BIL-S-063609	47500
36U X 600 X 1000	1	BIL-S-063610	50035
42U X 600 X 900	1	BIL-S-064209	53410
42U X 600 X 1000	1	BIL-S-064210	56800
42U X 800 X 1000	1	BIL-S-084210	65365
45U X 600 X 900	1	BIL-S-064509	61720
45U X 600 X 1000	1	BIL-S-064510	65300

MOQ - Minimum order quantity in nos.

Notes : Server racks price do not include freight & this will be extra at actuals.

STANDARD CONFIGURATION: Basic frame, Top & bottom, Front Glass door with perforation, Rear vented door, Lockable & detachable side panels, 2-Pairs of 19" rails with depth members.



Key Attributes:

- Includes 1-Pair of 21" rails.
- Integrated side panels.
- Grouting arrangements along with grouting bolts as std. BOM
- Provision for power & detachable Cable entry/exit in top & bottom.
- Power coated to shade RAL : 7035 structure finish.

ETSI Racks

HSN Code : 8538

Dimensions (H x W x D) mm	MOQ Nos.	Cat. No.	List Price [₹]
2200 X 600 x 300	1	ITE-062203	On request
2200 X 600 x 600	1	ITE-062206	On request

MOQ - Minimum order quantity in nos.

Notes : Above ETSI configuration do not include front & rear door and covers.

All other accessories will be extra & will be furnished on request.

The prices mentioned above do not include freight.



Key Attributes:

- 1-Pair of vertical cable manager is default design.
- Surface pretreated and advance powder coated
- Grouting bolts as std. BOM.
- Power coated to shade RAL : 7035 structure finish.

19" Open Racks

HSN Code : 8538

Dimensions (H x W) mm	MOQ Nos.	Cat. No.	List Price [₹]
36U X 600	1	ITE-OF-0636	On request
45U X 600	1	ITE-OF-0645	On request

MOQ - Minimum order quantity in nos.

Notes : 1) Above Open Rack configuration does not include Shelves, Doors and Covers. All other accessories prices will be extra and will be furnished on request.

2) The Prices above do not include Freight and this will be extra at actuals.

For more details, visit : www.bchindia.com/technorack

*List Prices are Ex-works Faridabad. For detail refer Enclosure Selling Terms & Conditions.

***GST to be charged extra**

Accessories for 19" Racks

Fixed Shelf/Stationary Shelf

- Compatible to keep monitor, servers, non 19" Networking & allied equipments.

Key-Board Tray

- Sliding & rotatory type.

Canteliver Shelf

- It can accommodate light weighted networking & allied equipments like modem, routers etc.

Equipment Support Angle

- "L" type angles. Useful to keep non 19" heavy duty equipment in rack mounting position.

Sliding Shelf

- Useful to keep servers, networking & allied equipment which are required to slide out for operational & other purpose.

Fans/Fan Tray

- 220V 90 CFM Capacity. Can be mounted at the top either directly or through Fan housing unit (Fan Tray)

6-Point 5A Hor. Power Strip

- All universal type socket along with on/off switch with fuse & indicator. Internal strips are made up of Berellium copper that has high rate of heat & mechanical tolerance.
- Other 5A or 5/15A Power strips have Indian style (Anchor) Sockets with on/off switch/MCB.

Castors

- 1-Set includes 4Nos. of castors, 2Nos. with foot operated brake & remaining 2 are free.

Levelling Feet

- 1-Set includes 4Nos. of Levelling Feet.

Stability Plate

- It Prevents the racks from toppling while taking out heavy duty servers.

Shelves

HSN Code : 8538

Description	Cat No.	List Price [₹]
Fixed Shelf (600mmD)	BIL-A-FS-L-06	1545
Fixed Shelf (800mmD)	BIL-A-FS-L-08	2390
Fixed Shelf (900mmD)	BIL-A-FS-L-09	2655
Fixed Shelf (1000mmD)	BIL-A-FS-L-10	2860
Key board tray (Sliding & Rotatory)	BIL-A-KB-06	4565
Canteliver Shelf (1U)	BIL-A-CS-1	925
Canteliver Shelf (2U)	BIL-A-CS-2	1370
Equipment Support Angle (600mmD)	BIL-A-ESA-06	580
Equipment Support Angle (800mmD)	BIL-A-ESA-08	655
Equipment Support Angle (900mmD)	BIL-A-ESA-09	810
Equipment Support Angle (1000mmD)	BIL-A-ESA-10	940
Sliding Shelf (900mmD)	BIL-A-SS-09	4565
Sliding Shelf (1000mmD)	BIL-A-SS-10	4740

Thermal Management

HSN Code : 8538

Description	Cat No.	List Price [₹]
1-Fan (Direct mounted)	BIL-A-SF	1545
Fan-tray with 2-Fans (FHU)	BIL-A-FHU-2FANS	3300
Fan-tray with 4-Fans (FHU)	BIL-A-FHU-4FANS	5745

Cable Management

HSN Code : 8538

Description	Cat No.	List Price [₹]
Horizontal Cable Manager (1U)	BIL-A-HCM-1U	370
Horizontal Cable Manager (2U)	BIL-A-HCM-2U	455
Vertical Cable Manager (24U)	BIL-A-VCM-24U	580
Vertical Cable Manager (30U)	BIL-A-VCM-30U	735
Vertical Cable Manager (36U)	BIL-A-VCM-36U	835
Vertical Cable Manager (42U)	BIL-A-VCM-42U	925
Vertical Cable Manager (45U)	BIL-A-VCM-45U	1010

Power Management

HSN Code : 8538

Description	Cat No.	List Price [₹]
6-Point 5Amp Horizontal Power Strip (19")	BIL-A-HPS-5AMP	1510
5-Point 5/15Amp Horizontal Power Strip (19")	BIL-A-HPS-15AMP	2010
12-Point 5Amp Vertical Power Strip	BIL-A-12VPS-5AMP	2940
10-Point 5/15Amp Vertical Power Strip	BIL-A-10VPS-15AMP	3375
Earth continuity Kit (Earthing Kit)	BIL-A-ECT	1145

Stability Management

HSN Code : 8538

Description	Cat No.	List Price [₹]
Castors (1-Set) Heavy Duty	BIL-A-CAS-HD	5510
Castors (1-Set) Light Duty	BIL-A-CAS	4385
Levelling Feet (1-Set)	BIL-A-LF	750

Miscellaneous

HSN Code : 8538

Description	Cat No.	List Price [₹]
BAYING KIT	BIL-A-BK	545
BLANKING PANEL (1U)	BIL-A-BP-1U	255
BLANKING PANEL (2U)	BIL-A-BP-2U	340
BLANKING PANEL (3U)	BIL-A-BP-3U	425
BLANKING PANEL (4U)	BIL-A-BP-4U	525
BLANKING PANEL (5U)	BIL-A-BP-5U	590
Captive H/w (set of 10)	BIL-A-Captive-M6	255
Wall mounting H/w (set of 4)	BIL-A-WALLMOUNTHW	265

Notes : Packing & forwarding will be extra if accessories are ordered separately.

*List Prices are Ex-works Faridabad. For detail refer Enclosure Selling Terms & Conditions.

***GST to be charged extra**

www.bchindia.com



Technical Particulars :

- Enclosure with In built hinges for front door
- Pad locking provision for front door
- Suitable for wall & pole mounting
- Front door locked with rust proof hardware
- Silicon Gasket between enclosure and front door for sealing
- Protection Category IP-67

Type-1 (Inbuilt Hinged Door Enclosure)

Box & Cover both in ABS		Box in ABS & Cover in PC(TR)		Box & Cover both in PC	
Cat No.	List Price [₹]	Cat No.	List Price [₹]	Cat No.	List Price [₹]
BIL-AB-1.01	1270	BIL-AP-1.01	1405	BIL-PC-1.01	1550
BIL-AB-1.02	1310	BIL-AP-1.02	1455	BIL-PC-1.02	1590
BIL-AB-1.03	1535	BIL-AP-1.03	1695	BIL-PC-1.03	1860
BIL-AB-1.04	1815	BIL-AP-1.04	2010	BIL-PC-1.04	2195
BIL-AB-1.05A	2570	BIL-AP-1.05A	2860	BIL-PC-105A	3150
BIL-AB-1.05B	2780	BIL-AP-1.05B	3085	BIL-PC-105B	3400
NA	-	NA	-	BIL-PC-1.06	13795

Technical Particulars :

- Plain walled enclosures came along with front removable Cover
- Rust proof polyamide screw for front cover
- Equipped with parallel inner bush ribs for din channels Self-tapping screws
- Silicon Gasket between enclosure and front cover for sealing
- Protection Category IP-67

Type-2 (Plain Walled Industrial Enclosure)

Box & Cover both in ABS		Box in ABS & Cover in PC(TR)		Box & Cover both in PC	
Cat No.	List Price [₹]	Cat No.	List Price [₹]	Cat No.	List Price [₹]
BIL-AB-2.00A	775	BIL-AP-2.00A	845	BIL-PC-2.00A	920
BIL-AB-2.01A	910	BIL-AP-2.01A	1000	BIL-PC-2.01A	1085
BIL-AB-2.01	1030	BIL-AP-2.01	1125	BIL-PC-2.01	1225
BIL-AB-2.02	1280	BIL-AP-2.02	1405	BIL-PC-2.02	1535
BIL-AB-2.03	1895	BIL-AP-2.03	2095	BIL-PC-2.03	2300
BIL-AB-2.04	2925	BIL-AP-2.04	3240	BIL-PC-2.04	3550
BIL-AB-2.04B	3735	BIL-AP-2.04B	4085	BIL-PC-2.04B	4435
BIL-AB-2.05A	5380	BIL-AP-2.05A	6040	BIL-PC-2.05A	6700
NA	-	NA	-	BIL-PC-2.05B	8175
NA	-	NA	-	BIL-PC-2.06	6645

Technical Particulars :

- Modular in nature and ideal for LV compartmentalized Panel
- Knock outs on box walls for bus bar and cables routing
- Molded silicon push lock jointing kits to maintain IP rating of enclosure After joining each other
- Silicon Gasket between enclosure and front cover for sealing
- Can be joined in modules to make any size of electrical LV panel
- Protection Category IP-67

Type-3 (Modular Panel Enclosure)

Box & Cover both in ABS		Box in ABS & Cover in PC(TR)		Box & Cover both in PC	
Cat No.	List Price [₹]	Cat No.	List Price [₹]	Cat No.	List Price [₹]
BIL-AB-3.01A	2030	BIL-AP-3.01A	2215	BIL-PC-3.01A	2400
BIL-AB-3.01B	2390	BIL-AP-3.01B	2610	BIL-PC-3.01B	2820
BIL-AB-3.02	3305	BIL-AP-3.02	3630	BIL-PC-3.02	3955
BIL-AB-3.03	4035	BIL-AP-3.03	4435	BIL-PC-3.03	4840
BIL-AB-3.04	4995	BIL-AP-3.04	5520	BIL-PC-3.04	6040

*List Prices are Ex-works Faridabad. For detail refer Enclosure Selling Terms & Conditions.

*GST to be charged extra

www.bchindia.com

Type-4 (Junction Boxes)

Technical Particulars :

- Equipped with multiple knockouts to accommodate different size of cables
- Front cover fixes with SS304 screws
- No of inner bush for din rail fixing
- Silicon Gasket between enclosure and front cover for sealing
- Outside bushes provided to mount box without tampering enclosures to maintain IP rating
- Protection Category IP-67

Box & Cover both in ABS		Box in ABS & Cover in PC(TR)		Box & Cover both in PC	
Cat No.	List Price [₹]	Cat No.	List Price [₹]	Cat No.	List Price [₹]
BIL-AB-4.01B	350	BIL-AP-4.01B	375	BIL-PC-4.01B	395
BIL-AB-4.02B	450	BIL-AP-4.02B	490	BIL-PC-4.02B	525
BIL-AB-4.03B	560	BIL-AP-4.03B	610	BIL-PC-4.03B	655
BIL-AB-4.04B	655	BIL-AP-4.04B	710	BIL-PC-4.04B	765
BIL-AB-4.05B	720	BIL-AP-4.05B	785	BIL-PC-4.05B	855
BIL-AB-4.06	880	BIL-AP-4.06	955	BIL-PC-4.06	1030
BIL-AB-4.07	1460	BIL-AP-4.07	1725	BIL-PC-4.07	1985

Type-5 (Power Distribution Boxes With Poly Carbonate Window)

Technical Particulars :

- Suitable for wall or Pole mounting
- Polycarbonate hinged window for easy operation of MCB
- Number of horizontal inner bush for din rail fixing
- Rust proof SS304 screw for front cover fixing
- Silicon Gasket between enclosure and front cover for sealing
- Front cover fixed with rust proof SS304 screws
- Protection Category IP-65

Box & Cover both in ABS		Box in ABS & Cover in PC(TR)		Box & Cover both in PC	
Cat No.	List Price [₹]	Cat No.	List Price [₹]	Cat No.	List Price [₹]
NA	-	BIL-AP-5.01 Eco	890	NA	-
NA	-	BIL-AP-5.01B Eco	805	NA	-
NA	-	BIL-AP-5.01	1255	NA	-
NA	-	BIL-AP-5.02 Eco	1145	NA	-
NA	-	BIL-AP-5.02B Eco	1010	NA	-
NA	-	BIL-AP-5.02	1625	NA	-
NA	-	BIL-AP-5.03	2075	NA	-
NA	-	BIL-AP-5.04	2530	NA	-
NA	-	BIL-AP-5.05 A	3745	NA	-
NA	-	BIL-AP-5.05	4630	NA	-
NA	-	BIL-AP-5.06	6620	NA	-

Type-6 (Enclosure With External Mounting)

Technical Particulars :

- Provision of outside mounting on enclosure
- Suitable for heavy duty application like Bus bars, industrial plugs sockets & Solar application
- Number of horizontal inner bush for din rail fixing
- Rust proof SS304 screw for front cover fixing
- Silicon Gasket between enclosure and front cover for sealing
- Protection Category IP-67

Box & Cover both in ABS		Box in ABS & Cover in PC(TR)		Box & Cover both in PC	
Cat No.	List Price [₹]	Cat No.	List Price [₹]	Cat No.	List Price [₹]
BIL-AB-6.01	430	NA	-	NA	-
BIL-AB-6.02A	560	BIL-AP-6.02A	605	NA	-
BIL-AB-6.02B	665	BIL-AP-6.02B	720	NA	-
BIL-AB-6.03	575	BIL-AP-6.03	620	NA	-
BIL-AB-6.04	795	NA	-	NA	-
BIL-AB-6.05	1085	NA	-	NA	-
BIL-AB-6.06A	965	BIL-AP-6.06A	1040	NA	-
BIL-AB-6.06B	1200	BIL-AP-6.06B	1300	NA	-
BIL-AB-6.07	1690	BIL-AP-6.07	1870	NA	-
BIL-AB-6.08	2725	NA	-	NA	-
BIL-AB-6.09	3865	NA	-	NA	-

*List Prices are Ex-works Faridabad. For detail refer Enclosure Selling Terms & Conditions.

*GST to be charged extra

Type-7 (Enclosure With External Mounting)

Technical Particulars :

- Specially designed for IT, electronics and automation industrial solutions
- Available in 31 different sizes
- Provision of PCB & Electronics component mounting
- Rust proof SS304 screw for front cover fixing
- Silicon Gasket between enclosure and front door for sealing
- Suitable for wall & pole mounting
- Protection Category IP-67

Box & Cover both in ABS		Box in ABS & Cover in PC(TR)		Box & Cover both in PC	
Cat No.	List Price [₹]	Cat No.	List Price [₹]	Cat No.	List Price [₹]
BIL-AB-7.01	305	NA	-	BIL-PC-7.01	340
BIL-AB-7.02	460	BIL-AP-7.02	500	NA	-
BIL-AB-7.03	350	NA	-	NA	-
BIL-AB-7.04	450	NA	-	NA	-
BIL-AB-7.05	560	BIL-AP-7.05	615	NA	-
BIL-AB-7.06A	395	NA	-	NA	-
BIL-AB-7.06B	515	NA	-	NA	-
BIL-AB-7.07	720	BIL-AP-7.07	785	NA	-
BIL-AB-7.07B	600	BIL-AP-7.07B	635	NA	-
BIL-AB-7.08	600	NA	-	NA	-
BIL-AB-7.08A	820	BIL-AP-7.08A	900	BIL-PC-7.08A	975
BIL-AB-7.08C	910	BIL-AP-7.08C	995	BIL-PC-7.08C	1075
BIL-AB-7.09A	710	NA	-	NA	-
BIL-AB-7.09B	775	NA	-	NA	-
BIL-AB-7.10A	840	BIL-AP-7.10A	On request	BIL-PC-7.10A	935
BIL-AB-7.10B	830	NA	-	BIL-PC-7.10B	1010
BIL-AB-7.11	460	NA	-	NA	-
BIL-AB-7.12	880	NA	-	NA	-
BIL-AB-7.13	865	NA	-	NA	-
BIL-AB-7.13A	775	NA	-	NA	-
BIL-AB-7.14	900	NA	-	NA	-
BIL-AB-7.15	890	NA	-	NA	-
BIL-AB-7.16	1840	NA	-	NA	-
BIL-AB-7.18	1515	BIL-AP-7.18	1660	BIL-PC-7.18	1805
BIL-AB-7.19	1065	NA	-	NA	-
BIL-AB-7.20	2345	NA	-	NA	-
BIL-AB-7.01L	280	BIL-AP-7.01L	300	NA	-
BIL-AB-7.02L	405	BIL-AP-7.02L	435	BIL-PC-7.02L	460
BIL-AB-7.03L	675	BIL-AP-7.03L	720	NA	-



*List Prices are Ex-works Faridabad. For detail refer Enclosure Selling Terms & Conditions.

***GST to be charged extra**

www.bchindia.com



Price List

General Terms & Conditions

Prices are subject to change without any prior notice and will be applicable as prevailing at the time of dispatch.

- The prices are ex-works basis..
- The prices given in this list are effective as on date and are subject to change without notice.
- The List Prices (LP) mentioned are exclusive of GST.
- The duties, taxes and other statutory levies are based on rates prevailing at the time of billing. Any subsequent revision of those rates having retrospective effective shall be to customer's account.
- In case where any GST exemption has been claimed, the purchaser is responsible for providing the necessary GST exemption form within the specified period, failing which the purchaser would be liable for the payment of full GST plus applicable interest and penalties
- All Prices are in Indian Rupees (₹).
- Alteration made after receipt of confirmation of order are subject to price & delivery revisions and any other expenses or levies
- The dispute, if any, will be resolved mutually by discussion. However, if no settlement is forthcoming then, the Courts at New Delhi shall only have territorial jurisdiction to hear and decide the dispute.

Warranty

All products, unless specifically mentioned otherwise, shall have warranty, against manufacturing defects for a period of 18* months from the date of invoicing & 24 months from date of manufacturing whichever is later subject to the provision of proper usage and does not cover defects arising out of fire, accident, inefficient maintenance, faulty operation and willful or accidental damage. The manufacturer shall not be liable for any consequential loss, injury or damages attributable to defect or failure of its products.

* Proof of purchase to be retained to avail warranty.

a strong commitment
to serve better
always ...



Switchgear | Controlgear | Enclosures | Motor Starters & Submersible Pump Starters |
Brakes and Crane Controls | MCC | PCC | Customised Solutions | Automation |
Wires & Cables | Motors | Reactive Power Management



BCH
ELECTRIC
LIMITED

www.bchindia.com

- Power Control Products
- Starters & Submersible Pump Starters
- Industrial Enclosures
- Industrial Products
- Wires & Cables
- Motor Control Products
- Power Bus Duct
- Customised Solution
- Automation



BCH ELECTRIC LIMITED



www.bchindia.com



1800-103-9262
customer@bchindia.com

Visit us at : www.bchindia.com

Registered & Corporate Office : 1105, New Delhi House, 27, Barakhamba Road, New Delhi - 110 001 Tel. : 91-11- 43673100

CIN : U31103DL1965PLC425953, **Customercare No.** 1800-103-9262, **E-mail :** marketing@bchindia.com

Works 1 : 20/4, Mathura Road, Faridabad - 121 006 (Haryana) Tel. : 0129-4063000/4293000 Fax : 0129-2304016

Works 2 : 64-68, Sector-7, IIE, Pant Nagar, Rudrapur, Udham Singh Nagar - 263 153 (Uttarakhand) Tel. : 05944-250214/16 Fax : 05944-250215

Sales Offices :

Ahmedabad
401, Shilp Zeveri,
Beside Shyamal Iconic,
Above Westside,
Shyamal Cross Road,
Ahmedabad - 380015
E-mail: ahmedabad@bchindia.com

Bangalore
2nd Floor, 130/5,
K.H. Road (Double road),
Bangalore - 560 027
Tel. : 080-41144879 / 22236759
E-mail : bangalore@bchindia.com

Bhubaneswar
Mallick Commercial
Complex Plot No. : A/69, unit - 3
Bhubaneswar - 751 001
Tel.: 0674-2380988
E-mail.: bhubaneswar@bchindia.com

Chandigarh (Panchkula)
SCO -270, 2nd Floor,
Sector-16, Panchkula
Haryana-134 113
Tel. : 0172-5078957 / 5049905
E-mail.: chandigarh@bchindia.com

Chennai
Flat No. 3A, 3rd Floor,
Sree Apartments,
No.508, TTK Road,
Alwarpet, Chennai 600 018
Tel.: 044-24337046, 24337047
E-mail : chennai@bchindia.com

Coimbatore
87, Dr. Narajappa Road,
Coimbatore - 641 018
Tel. : 0422-2305311 / 2302599
E-mail : coimbatore@bchindia.com

Delhi 1
801, Akash Deep Building,
26A, Barakhamba Road,
New Delhi - 110 001
Tel. : 011-23313878 / 43518200
E-mail : delhi@bchindia.com

Delhi 2
710, Deepali Building, 92
Nehru Place, New Delhi - 110
019 Tel. : 011-45720334
E-mail : delhi2@bchindia.com

Dehradun
8, Co-operative Industrial Estate,
Patel Nagar, Dehradun-248001
E-mail : dehradun@bchindia.com

Faridabad
20/4, Mathura Road,
Faridabad - 121 006 (Haryana)
Telfax : 0129-4293009
E-mail : faridabad@bchindia.com

Hyderabad
1-8-303/48/13/102, Arya One,
2nd Floor, P. G. Road,
Secunderabad - 500 003
Tel. : 040-66206263/27890306
Fax : 040-66207273
E-mail : hyderabad@bchindia.com

Indore
330-331, Indraprastha Tower,
3rd Floor, 6, M.G. Road,
Indore - 452 001
Tel. : 0731-2510011 / 2510012
E-mail : indore@bchindia.com

Jaipur
25, Hathroi, Gopalbari,
Jaipur - 302 001
Tel. : 0141-2363521
E-mail : jaipur@bchindia.com

Jamshedpur
A.J. Tower, 2B,
2nd Floor, R-Road, Bistupur,
Jamshedpur - 831 001
E-mail : jamshedpur@bchindia.com

Kolkata
Block 1E, 216,
Acharya Jagadish Chandra Bose
Road, Kolkata - 700 017
Tel. : 033-22871728 / 46021884
E-mail : kolkata@bchindia.com

Lucknow
Shop No. 3, First Floor,
Tower T-10, Millennium Place IBB - 2,
Sushant Golf City, Sultanpur Road,
Lucknow U.P. - 226030
Tel. : 0522-4025597/4025997
E-mail : lucknow@bchindia.com

Ludhiana
S.C.O. - 18, 2nd Floor,
Feroze Gandhi Market,
Ludhiana - 140 001
Tel. : 0161-5021807/5022808
E-mail : ludhiana@bchindia.com

Madurai
12, Parvathi Plaza-3rd Floor,
70 Feet Road, Ellis Nagar
Madurai-625016, Tamilnadu
Email: madurai@bchindia.com

Mumbai
A-151, Mittal Tower,
Nariman Point,
Mumbai - 400 021
Tel. : 022-22822947/22850162
Fax : 022-22822858
E-mail : mumbai@bchindia.com

Patna
No.703, 7th Floor, Luv Kush
Tower, Exhibition Road,
Patna - 800001

Pune
8, Sarosh Bhavan,
16-B/1, Dr. Ambedkar Road,
Pune - 411 001
Tel. : 020-41210002
E-mail : pune@bchindia.com

Raipur
6th Floor, Office No. 607,
Babylon Capital, Near Oswal
Petrol Pump, VIP Chowk,
G.E. Road, Raipur - 492 006
Tel. : 0771- 4045053
E-mail : raipur@bchindia.com

Vadodara
301, Third Floor, "Florence Classic",
10, Ashapuri Co-Op. Hsg. Soc. Ltd., Opp. VUDA
Housing, Near Cow Circle, Akota, Vadodara - 390 020
Tel. : 0265-2345068/2345069
Telefax : 0265-2345068,
E-mail : vadodara@bchindia.com

Other Branch Locations

Cochin : cochin@bchindia.com, **Guwahati :** guwahati@bchindia.com, **Vishakapatnam :** vizag@bchindia.com, **Surat :** surat@bchindia.com, **Trichy :** Trichy@bchindia.com

Resident Engineer Locations

Agra	Bhopal	Hospet	Kanpur	Muzaffarnagar	Rajahmundry	Siliguri	Varanasi
Ahmednagar	Calicut	Hubli	Karimnagar	Nanded	Ranchi	Solapur	Vijaywada
Ambala	Goa	Idukki	Karnal	Nashik	Rourkela	Srinagar	Vishakapatnam
Anantapur	Gulbarga	Jabalpur	Kota	Panipat	Rudarpur	Trivendrum	Vellore
Ankleshwar	Gurgaon	Jalandhar	Kurnool	Patna	Salem	Tirunelveli	Vilupuram
Aurangabad	Haridwar	Jodhpur	Midnapore	Puducherry	Sikar	Udaipur	Warangal
Bhiwadi	Hisar	Kashipur	Mahua	Rajkot	Silchar	Vapi	Yamunanagar